

HYDRAULIC HOSE FITTINGS & ADAPTERS



ALFAGOMMA

Since 1956 ALFAGOMMA has been manufacturing and delivering top quality products all over the world.

ALFAGOMMA believe in the importance of offering an excellent service to all its customers along with a continuous new product research and development, a technical innovation and customized solutions, a constant high quality exceeding ISO 9001 quality standards and full compliance with ISO 14001 environmental norms, a global presence and logistic support a strong OEM expertise and customized solutions.



// MAIN PLANTS OVERVIEW



// CORE BUSINESS

ALFAGOMMA strategy is to be a single source integrated system supplier supporting its partners with a complete product range:

- Hydraulic Rubber & Thermoplastic Hose
- Fittings & Adapters
- Quick Release Couplings and Multi-K
- Swivel & Plug-in Connectors
- Hydraulic Hose Assemblies
- Manipulated Tubes
- Industrial Rubber, Thermoplastic & Composite Hose
- Industrial Stainless Steel Corrugated Hose
- Industrial Fittings
- Industrial Hose Assemblies

// GLOBAL PRESENCE AND LOGISTIC SUPPORT

The ALFAGOMMA Group currently employs over 3550 people worldwide in 20 Production Plants and 84 Regional Distribution – Assembly Centers strategically located in:



AMERICAS

- // Brazil
- // Canada
- // USA

AFRICA

- // South Africa

EUROPE

- // Italy
- // Denmark
- // Estonia
- // Finland
- // France
- // Germany
- // Greece
- // Netherland
- // Norway
- // Sweden
- // UK

ASIA & PACIFIC

- // Australia
- // China
- // Indonesia
- // Malaysia
- // Singapore
- // South Korea

// APPLICATIONS OVERVIEW



ALFAGOMMA

COMPLETE AND INTEGRATED HYDRAULIC SYSTEM



ALFAGOMMA COMPLETE SYSTEM

- ▲ SAFE AND RELIABLE INTEGRATED SYSTEM
- ▲ FULL RANGE OF HOSES, FITTINGS, ADAPTORS AND QUICK RELEASE COUPLINGS
- ▲ CARBON STEEL AND STAINLESS STEEL RIGID PIPES
- ▲ CUSTOMISED SYSTEMS AND KITS
- ▲ WIDE RANGE OF ARTICLES IN STOCK
- ▲ TOP COAT SURFACE TREATMENT ON ALL OUR METAL PARTS
- ▲ 100% TRACEABILITY FOR EVERY SINGLE COMPONENT







ALFAGOMMA

**MINETUFF
HIGH ABRASION
RESISTANCE**



MINETUFF COVER

-  **EXCELLENT ABRASION RESISTANCE (10 TIMES HIGHER THAN EN-ISO 6945 REQUIREMENT)**
-  **HIGH OZONE RESISTANCE (10 TIMES MORE THAN THE STANDARD)**
-  **MSHA APPROVED COVER**
-  **ALTERNATIVE TO PROTECTIVE SLEEVE IN APPLICATIONS REQUIRING ABRASION RESISTANCE**



// HYDRAULIC HOSE

// HYDRAULIC HOSE	8
// FERRULE SELECTION CHART	40



// HYDRAULIC FITTING

// STANDARD	46
// MULTISPIRAL	100
// INTERLOCK	116



// ALFACRIMP

// C12A	134
// C124	161
// C126	183



// HYDRAULIC ADAPTER

// JIC 37° ADAPTERS	193
// ORFS ADAPTERS	234
// BSP ADAPTERS	262
// DIN 24° ADAPTERS.....	277

// SYMBOLS



INTERNAL DIAMETER

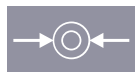

OUTSIDE DIAMETER



MAXIMUM WORKING PRESSURE



MINIMUM BURST PRESSURE



MINIMUM BEND RADIUS



WALL THICKNESS



WEIGHT



// HYDRAULIC HOSE

// THERMOPLASTIC.....	9	// HIGH TEMPERATURE.....	31
// TEXTILE BRAID.....	12	// LOW TEMPERATURE.....	33
// WIRE BRAID.....	14	// OIL RETURN LINES.....	35
// WIRE SPIRAL.....	21	// PRESSURE WASH.....	37
// ALFABIOTECH.....	26	// PTFE HOSE.....	38
// SUPERTUFF.....	29		

Dimensions shown may be changed without prior notice

// THERMOPLASTIC

// MINIMESS



PRESSURE TEST POINT

Tube: polyester.**Reinforcement:** one high tensile steel braid.**Cover:** abrasion, ozone and hydrocarbon resistant polyurethane, pin-pricked.**Application:** high pressure hydraulic lines, fuel oil, antifreeze solutions, air and water. Specially designed for pressure gauges and transducers connections.**Constant operation:** -40 °C +100 °C (-40 °F +212 °F)
air max T = +70 °C (+160 °F)**Safety factor:** 1:4**Length:** random

Item Code	↔			↔		↻		↻		⤴		⚖	
	Dash	mm	in	mm	in	Mpa	psi	Mpa	psi	mm	in	kg/m	lb/ft
1000310	01	2,0	5/64"	5,00	0,20	63,0	9100	190,0	27300	20,0	0,79	0,020	0,02

// FLEXOR 7



SAE 100 R7 - EN 855 R7

Tube: polyester.**Reinforcement:** one/two high tensile textile braids.**Cover:** abrasion, ozone and hydrocarbon resistant polyurethane, pin-pricked.**Application:** high pressure hydraulic lines, fuel oil, antifreeze solutions, air and water.**Constant operation:** -40 °C +100 °C (-40 °F +212 °F)
air max T = +70 °C (+160 °F)**Safety factor:** 1:4**Length:** random

Item Code	↔			↔		↻		↻		⤴		⚖	
	Dash	mm	in	mm	in	Mpa	psi	Mpa	psi	mm	in	kg/m	lb/ft
1000290	03	5,0	3/16"	9,60	0,38	21,0	3000	84,0	12000	25,0	0,98	0,060	0,05
1000291	04	6,0	1/4"	12,20	0,48	21,0	3000	84,0	12000	35,0	1,38	0,100	0,07
1000292	05	8,0	5/16"	14,30	0,56	19,0	2750	76,0	11000	45,0	1,77	0,130	0,09
1000293	06	10,0	3/8"	16,00	0,63	16,0	2320	64,0	9280	55,0	2,17	0,145	0,10
1000294	08	13,0	1/2"	20,30	0,80	14,0	2000	56,0	8000	75,0	2,95	0,220	0,15

// FLEXOR 7 - TWIN



SAE 100 R7 - EN 855 R7

Tube: polyester.
Reinforcement: one/two high tensile textile braids.
Cover: abrasion, ozone and hydrocarbon resistant polyurethane, pin-pricked.
Application: high pressure hydraulic lines, fuel oil, antifreeze solutions, air and water.
Constant operation: -40 °C +100 °C (-40 °F +212 °F)
 air max T = +70 °C (+160 °F)
Safety factor: 1:4
Length: random

Item Code	↔			↔		↻		↻		⤴		⚖	
	Dash	mm	in	mm	in	Mpa	psi	Mpa	psi	mm	in	kg/m	lb/ft
1000298	04	6,0	1/4"	12,20	0,48	21,0	3000	84,0	12000	35,0	1,38	0,200	0,14
1000299	05	8,0	5/16"	14,30	0,56	19,0	2750	76,0	11000	45,0	1,77	0,260	0,18
1000300	06	10,0	3/8"	16,00	0,63	16,0	2320	64,0	9280	55,0	2,17	0,290	0,20
1000301	08	13,0	1/2"	20,30	0,80	14,0	2000	56,0	8000	75,0	2,95	0,440	0,30

// FLEXOR 8



SAE 100 R8 - EN 855 R8

Tube: polyester.
Reinforcement: one/two braids of aramid fiber.
Cover: abrasion, ozone and hydrocarbon resistant polyurethane, pin-pricked.
Application: high pressure hydraulic lines, fuel oil, antifreeze solutions, air and water.
Constant operation: -40 °C +100 °C (-40 °F +212 °F)
 air max T = +70 °C (+160 °F)
Safety factor: 1:4
Length: random

Item Code	↔			↔		↻		↻		⤴		⚖	
	Dash	mm	in	mm	in	Mpa	psi	Mpa	psi	mm	in	kg/m	lb/ft
1000295	04	6,0	1/4"	11,50	0,45	35,0	5000	140,0	20000	50,0	1,97	0,085	0,06
1000483	05	8,0	5/16"	13,40	0,53	30,0	4300	120,0	17450	55,0	2,17	0,105	0,08
1000296	06	10,0	3/8"	15,50	0,61	28,0	4000	112,0	16000	60,0	2,36	0,135	0,10
1000416	08	13,0	1/2"	19,90	0,78	24,5	3500	98,0	14000	80,0	3,15	0,200	0,14

Dimensions shown may be changed without prior notice

// FLEXOR TWB1



ONE WIRE BRAID

Tube: polyester.**Reinforcement:** one high tensile steel braid.**Cover:** abrasion, ozone and hydrocarbon resistant polyurethane, non pin-pricked.**Application:** high pressure hydraulic lines, fuel oil, antifreeze solutions, air and water.**Constant operation:** -40 °C +100 °C (-40 °F +212 °F)

air max T = +70 °C (+160 °F)

Safety factor: 1:4**Length:** random

Item Code	↔			↔		↻		↻		⤴		⚖	
	Dash	mm	in	mm	in	Mpa	psi	Mpa	psi	mm	in	kg/m	lb/ft
1000283	04	6,0	1/4"	11,70	0,46	31,0	4500	124,0	18000	40,0	1,57	0,165	0,12
1000284	05	8,0	5/16"	13,20	0,52	25,0	3630	100,0	14500	55,0	2,17	0,190	0,13
1000285	06	10,0	3/8"	15,50	0,61	22,5	3250	90,0	13000	65,0	2,56	0,230	0,16
1000286	08	13,0	1/2"	18,80	0,74	19,0	2750	76,0	11000	85,0	3,35	0,300	0,21

// FLEXOR TWB1 - TWIN



ONE WIRE BRAID

Tube: polyester.**Reinforcement:** one high tensile steel braid.**Cover:** abrasion, ozone and hydrocarbon resistant polyurethane, non pin-pricked.**Application:** high pressure hydraulic lines, fuel oil, antifreeze solutions, air and water.**Constant operation:** -40 °C +100 °C (-40 °F +212 °F)

air max T = +70 °C (+160 °F)

Safety factor: 1:4**Length:** random

Item Code	↔			↔		↻		↻		⤴		⚖	
	Dash	mm	in	mm	in	Mpa	psi	Mpa	psi	mm	in	kg/m	lb/ft
1000289	04	6,0	1/4"	11,70	0,46	31,0	4500	124,0	18000	40,0	1,57	0,330	0,23
1000288	05	8,0	5/16"	13,20	0,52	25,0	3630	100,0	14500	55,0	2,17	0,380	0,26
1000287	06	10,0	3/8"	15,50	0,61	22,5	3250	90,0	13000	65,0	2,56	0,460	0,31

// TEXTILE BRAID

// ARGUS 1TE/R6 (HF)

**SAE 100 R6 - EN 854 R6 (up to 3/4") - EXCEEDS EN 854 1TE**

Tube: oil resistant synthetic rubber.

Reinforcement: one high tensile textile braid.

Cover: abrasion, ozone and hydrocarbon resistant synthetic rubber.

Application: low pressure hydraulic lines, fuel oil, antifreeze solutions, air and water.

HALOGEN-FREE COMPOUND

Constant operation: -40 °C +100 °C (-40 °F +212 °F)

air max T = +70 °C (+160 °F)

Safety factor: 1:4

Length: random

Item Code	↔			↔		↻		↻		⤴		⚖	
	Dash	mm	in	mm	in	Mpa	psi	Mpa	psi	mm	in	kg/m	lb/ft
1001385	04	6,0	1/4"	12,70	0,50	2,8	400	11,2	1620	64,0	2,52	0,110	0,08
1001386	05	8,0	5/16"	14,30	0,56	2,8	400	11,2	1620	76,0	2,99	0,130	0,09
1001387	06	10,0	3/8"	15,90	0,63	2,8	400	11,2	1620	76,0	2,99	0,160	0,11
1001388	08	13,0	1/2"	19,80	0,78	2,8	400	11,2	1620	102,0	4,02	0,220	0,15
1001389	10	16,0	5/8"	23,00	0,91	2,4	350	9,6	1400	107,0	4,21	0,270	0,19
1001390	12	19,0	3/4"	26,90	1,06	2,1	300	8,4	1200	152,0	5,98	0,330	0,23
1001391	16	25,0	1"	33,50	1,32	1,7	250	7,0	1000	203,0	7,99	0,500	0,34

// ARGUS 2TE (HF)

**EN 854 2TE**

Tube: oil resistant synthetic rubber.

Reinforcement: one high tensile textile braid.

Cover: abrasion, ozone and hydrocarbon resistant synthetic rubber.

Application: medium pressure hydraulic lines, fuel oil, antifreeze solutions, air and water.

HALOGEN-FREE COMPOUND

Constant operation: -40 °C +100 °C (-40 °F +212 °F)

air max T = +70 °C (+160 °F)

Safety factor: 1:4

Length: random

Item Code	↔			↔		↻		↻		⤴		⚖	
	Dash	mm	in	mm	in	Mpa	psi	Mpa	psi	mm	in	kg/m	lb/ft
1001398	04	6,0	1/4"	13,10	0,52	7,5	1100	30,0	4300	40,0	1,57	0,112	0,08
1001399	05	8,0	5/16"	14,90	0,59	6,8	986	27,0	3945	50,0	1,97	0,148	0,10
1001400	06	10,0	3/8"	16,50	0,65	6,3	920	25,2	3680	60,0	2,36	0,163	0,11
1001401	08	13,0	1/2"	19,70	0,78	5,8	840	23,2	3360	70,0	2,76	0,206	0,14
1001402	10	16,0	5/8"	23,90	0,94	5,0	730	20,0	2900	90,0	3,54	0,281	0,19
1001761	12	19,0	3/4"	27,00	1,06	4,5	650	18,0	2610	110,0	4,33	0,350	0,24
1001404	16	25,0	1"	34,40	1,35	4,0	600	16,0	2320	150,0	5,91	0,497	0,34

Dimensions shown may be changed without prior notice

// ARGUS 3TE/R3 (HF)**EN 854 3TE****Tube:** oil resistant synthetic rubber.**Reinforcement:** two high tensile textile braids.**Cover:** abrasion, ozone and hydrocarbon resistant synthetic rubber.**Application:** medium pressure hydraulic lines, fuel oil, antifreeze solutions, air and water.**HALOGEN-FREE COMPOUND****Constant operation:** -40 °C +100 °C (-40 °F +212 °F)

air max T = +70 °C (+160 °F)

Safety factor: 1:4**Length:** random

Item Code	↔			↔		↙		↘		⌒		⌚	
	Dash	mm	in	mm	in	Mpa	psi	Mpa	psi	mm	in	kg/m	lb/ft
1001405	04	6,0	1/4"	14,40	0,57	14,5	2100	58,0	8400	45,0	1,77	0,174	0,12
1001406	05	8,0	5/16"	16,90	0,67	13,0	1900	52,0	7560	55,0	2,17	0,223	0,15
1001407	06	10,0	3/8"	18,50	0,73	11,0	1600	44,0	6400	70,0	2,76	0,243	0,17
1001408	08	13,0	1/2"	21,70	0,85	9,3	1350	37,2	5400	85,0	3,35	0,294	0,20
1001409	10	16,0	5/8"	25,90	1,02	8,0	1200	32,0	4640	105,0	4,13	0,399	0,27
1001410	12	19,0	3/4"	29,00	1,14	7,0	1000	28,0	4000	130,0	5,12	0,455	0,31
1001411	16	25,0	1"	35,90	1,41	5,5	800	22,0	3200	150,0	5,91	0,612	0,42
1001412	20	32,0	1 1/4"	42,30	1,67	4,5	650	18,0	2610	190,0	7,48	0,737	0,50
1001531	24	38,0	1 1/2"	49,30	1,94	4,0	600	16,0	2320	240,0	9,45	1,150	0,78
1001532	32	51,0	2"	63,00	2,48	3,3	470	13,2	1900	300,0	11,81	1,500	1,01

// WIRE BRAID

// 2SC RAILWAY



ISO 11237 - EN 857 2SC

Tube: oil resistant synthetic rubber.

Reinforcement: two high tensile steel braids.

Cover: abrasion, ozone and hydrocarbon resistant synthetic rubber.

Application: high pressure hydraulic lines, fuel oil, antifreeze solutions, air and water. Specially designed for railway applications.

Constant operation: -40 °C +100 °C (-40 °F +212 °F)
air max T = +70 °C (+160 °F)

Safety factor: 1:4

Length: random

Item Code	↔			↔		↻		↻		⤴		⚖	
	Dash	mm	in	mm	in	Mpa	psi	Mpa	psi	mm	in	kg/m	lb/ft
1002687	04	6,0	1/4"	13,20	0,52	40,0	5850	160,0	23200	50,0	1,97	0,270	0,19
1002689	05	8,0	5/16"	14,50	0,57	35,0	5000	140,0	20000	55,0	2,17	0,310	0,21
1002690	06	10,0	3/8"	17,00	0,67	33,0	4800	132,0	19200	65,0	2,56	0,360	0,25
1002691	08	13,0	1/2"	20,30	0,80	27,5	4000	110,0	16000	90,0	3,54	0,470	0,32
1002692	10	16,0	5/8"	23,90	0,94	25,0	3630	100,0	14500	100,0	3,94	0,570	0,39
1002693	12	19,0	3/4"	27,70	1,09	21,5	3120	86,0	12500	120,0	4,72	0,760	0,52
1002694	16	25,0	1"	34,60	1,36	16,5	2400	66,0	9600	150,0	5,91	1,130	0,76

// FLEXOPAK PLT



Tube: oil resistant synthetic rubber.

Reinforcement: one high tensile steel braid.

Cover: abrasion, ozone and hydrocarbon resistant synthetic rubber.

Application: medium pressure hydraulic lines, fuel oil, antifreeze solutions, air and water. Specially designed for hydraulic pilot lines.

Constant operation: -40 °C +100 °C (-40 °F +212 °F)
air max T = +70 °C (+160 °F)

Safety factor: 1:4

Length: random

Item Code	↔			↔		↻		↻		⤴		⚖	
	Dash	mm	in	mm	in	Mpa	psi	Mpa	psi	mm	in	kg/m	lb/ft
1000274	03	5,0	3/16"	9,60	0,38	12,0	1750	48,0	7000	20,0	0,79	0,111	0,08
1000097	04	6,0	1/4"	11,40	0,45	12,0	1750	48,0	7000	30,0	1,18	0,150	0,11
1000475	05	8,0	5/16"	13,00	0,51	12,0	1750	48,0	7000	40,0	1,57	0,180	0,13
1000476	06	10,0	3/8"	14,70	0,58	12,0	1750	48,0	7000	60,0	2,36	0,220	0,15
1000347	08	13,0	1/2"	17,80	0,70	12,0	1750	48,0	7000	80,0	3,15	0,230	0,16

Dimensions shown may be changed without prior notice

// FLEXOPAK 1SC



ISO 11237 - EN 857 1SC

Tube: oil resistant synthetic rubber.**Reinforcement:** one high tensile steel braid.**Cover:** abrasion, ozone and hydrocarbon resistant synthetic rubber.**Application:** high pressure hydraulic lines, fuel oil, antifreeze solutions, air and water.**Constant operation:** -40 °C +100 °C (-40 °F +212 °F)

air max T = +70 °C (+160 °F)

Safety factor: 1:4**Length:** random

Item Code	↔			↔		↻		↻		⤴		⚖	
	Dash	mm	in	mm	in	Mpa	psi	Mpa	psi	mm	in	kg/m	lb/ft
1000305	08	13,0	1/2"	19,50	0,77	16,0	2320	64,0	9280	90,0	3,54	0,410	0,28
1000280	10	16,0	5/8"	23,00	0,91	13,0	1900	52,0	7560	100,0	3,94	0,440	0,30
1000251	12	19,0	3/4"	26,70	1,05	10,5	1530	42,0	6000	125,0	4,92	0,570	0,39
1000252	16	25,0	1"	34,90	1,37	8,8	1280	35,2	5100	150,0	5,91	0,740	0,50

// AT3K - MINETUFF



ISO 11237 - SAE 100 R17 - EN 857 1SC

Tube: oil resistant synthetic rubber.**Reinforcement:** one high tensile steel braid.**Cover:** abrasion, ozone and hydrocarbon resistant synthetic rubber.**MSHA APPROVED****Application:** high pressure hydraulic lines, fuel oil, antifreeze solutions, air and water.**Constant operation:** -40 °C +100 °C (-40 °F +212 °F)

air max T = +70 °C (+160 °F)

Safety factor: 1:4**Length:** random**Notes:** specification reference: SAE 100 R17 - ISO 11237 - EN 857 1SC (1/4, 5/16, 3/8)**Brand text:** specification reference: SAE 100 R17 - ISO 11237 - EN 857 1SC (1/4, 5/16, 3/8)







Item Code	↔			↔		↻		↻		⤴		⚖	
	Dash	mm	in	mm	in	Mpa	psi	Mpa	psi	mm	in	kg/m	lb/ft
1000167	04	6,0	1/4"	12,00	0,47	22,5	3250	90,0	13000	50,0	1,97	0,171	0,12
1000178	05	8,0	5/16"	13,30	0,52	21,5	3120	86,0	12500	55,0	2,17	0,190	0,13
1000106	06	10,0	3/8"	15,40	0,61	21,0	3000	84,0	12000	65,0	2,56	0,257	0,18
1000105	08	13,0	1/2"	19,20	0,76	21,0	3000	84,0	12000	90,0	3,54	0,360	0,25

// FLEXOR 1SN/R1AT 



ISO 1436-1 - SAE 100 R1AT - EN 853 1SN

Tube: oil resistant synthetic rubber.
Reinforcement: one high tensile steel braid.
Cover: abrasion, ozone and hydrocarbon resistant synthetic rubber.
Application: high pressure hydraulic lines, fuel oil, antifreeze solutions, air and water.
HALOGEN-FREE COMPOUND
Constant operation: -40 °C +100 °C (-40 °F +212 °F)
 air max T = +70 °C (+160 °F)
Safety factor: 1:4
Length: random up to 1" - 61 m max over 1"1/4







Item Code													
	Dash	mm	in	mm	in	Mpa	psi	Mpa	psi	mm	in	kg/m	lb/ft
1001330	03	5,0	3/16"	11,10	0,44	25,0	3630	100,0	14500	90,0	3,54	0,160	0,11
1001331	04	6,0	1/8"	12,70	0,50	22,5	3250	90,0	13000	100,0	3,94	0,198	0,14
1001332	05	8,0	5/16"	14,20	0,56	21,5	3120	86,0	12500	115,0	4,53	0,240	0,17
1001333	06	10,0	3/8"	16,50	0,65	18,0	2610	72,0	10500	130,0	5,12	0,300	0,21
1001334	08	13,0	1/2"	19,90	0,78	16,0	2320	64,0	9280	180,0	7,09	0,372	0,26
1001335	10	16,0	5/8"	23,00	0,91	13,0	1900	52,0	7560	200,0	7,87	0,420	0,29
1001336	12	19,0	3/4"	27,00	1,06	10,5	1530	42,0	6000	240,0	9,45	0,560	0,38
1001337	16	25,0	1"	35,00	1,38	8,8	1280	35,2	5100	300,0	11,81	0,876	0,59
1001338	20	32,0	1 1/4"	42,50	1,67	6,3	920	25,2	3680	420,0	16,54	1,095	0,74
1001339	24	38,0	1 1/2"	49,70	1,96	5,0	730	20,0	2900	500,0	19,69	1,329	0,90
1001340	32	51,0	2"	62,90	2,48	4,0	600	16,0	2320	630,0	24,80	1,835	1,24

// FLEXOR 1SN/R1AT - MINETUFF



ISO 1436-1 - SAE 100 R1AT - EN 853 1SN

Tube: oil resistant synthetic rubber.
Reinforcement: one high tensile steel braid.
Cover: abrasion, ozone and hydrocarbon resistant synthetic rubber.
MSHA APPROVED
Application: high pressure hydraulic lines, fuel oil, antifreeze solutions, air and water.
Constant operation: -40 °C +100 °C (-40 °F +212 °F)
 air max T = +70 °C (+160 °F)
Safety factor: 1:4
Length: random up to 1" - 61 m max over 1"1/4

Item Code													
	Dash	mm	in	mm	in	Mpa	psi	Mpa	psi	mm	in	kg/m	lb/ft
1002311	04	6,0	1/4"	12,70	0,50	22,5	3250	90,0	13000	100,0	3,94	0,192	0,13
1002312	05	8,0	5/16"	14,20	0,56	21,5	3120	86,0	12500	115,0	4,53	0,228	0,16
1002313	06	10,0	3/8"	16,50	0,65	18,0	2610	72,0	10500	130,0	5,12	0,287	0,20
1002314	08	13,0	1/2"	19,90	0,78	16,0	2320	64,0	9280	180,0	7,09	0,372	0,26
1002315	10	16,0	5/8"	23,00	0,91	13,0	1900	52,0	7560	200,0	7,87	0,420	0,29
1002316	12	19,0	3/4"	27,00	1,06	10,5	1530	42,0	6000	240,0	9,45	0,543	0,37
1002317	16	25,0	1"	35,00	1,38	8,8	1280	35,2	5100	300,0	11,81	0,864	0,59
1002497	20	32,0	1 1/4"	42,10	1,66	6,3	920	25,2	3680	420,0	16,54	1,042	0,71
1002319	24	38,0	1 1/2"	49,20	1,94	5,0	730	20,0	2900	500,0	19,69	1,330	0,90
1002321	32	51,0	2"	62,40	2,46	4,0	600	16,0	2320	630,0	24,80	1,835	1,24

Dimensions shown may be changed without prior notice

// FLEXOR 5



SAE 100 R5 - J1402 DOT AII FM VSS 106

Tube: oil resistant synthetic rubber.**Reinforcement:** one high tensile steel braid.**Cover:** braided high tensile textile cord.**Application:** medium pressure hydraulic lines, fuel oil, antifreeze solutions, air and water.**Constant operation:** -40 °C +100 °C (-40 °F +212 °F)
air max T = +70 °C (+160 °F)**Safety factor:** 1:4**Length:** random

Item Code	↔			↔		↻		↻		↷		♻	
	Dash	mm	in	mm	in	Mpa	psi	Mpa	psi	mm	in	kg/m	lb/ft
1000054	04	5,0	3/16"	13,20	0,52	20,7	3000	82,8	12000	76,0	2,99	0,230	0,16
1000055	05	6,3	1/4"	14,80	0,58	20,7	3000	82,8	12000	86,0	3,39	0,270	0,19
1000056	06	8,0	5/16"	17,30	0,68	15,5	2250	62,0	9000	102,0	4,02	0,350	0,24
1000049	07	10,3	13/32"	19,50	0,77	13,8	2000	55,2	8000	117,0	4,61	0,404	0,28
1000050	10	12,5	1/2"	23,40	0,92	12,1	1750	48,4	7000	140,0	5,51	0,560	0,38
1000051	12	16,0	5/8"	27,40	1,08	10,3	1500	41,4	6000	165,0	6,50	0,670	0,46
1000052	16	22,0	7/8"	31,40	1,24	5,5	800	22,0	3200	187,0	7,36	0,690	0,47
1000053	20	29,0	1 1/8"	38,10	1,50	4,3	625	17,2	2500	229,0	9,02	0,850	0,58
1000326	24	35,0	1 3/8"	44,50	1,75	3,4	525	13,8	2000	267,0	10,51	1,060	0,72
1000203	32	46,0	1 13/16"	56,40	2,22	2,4	350	9,6	1400	337,0	13,27	1,350	0,91

// FLEXOPAK 2SC (HF)



ISO 11237 - EN 857 2SC

Tube: oil resistant synthetic rubber.**Reinforcement:** two high tensile steel braids.**Cover:** abrasion, ozone and hydrocarbon resistant synthetic rubber.**Application:** high pressure hydraulic lines, fuel oil, antifreeze solutions, air and water.**HALOGEN-FREE COMPOUND****Constant operation:** -40 °C +100 °C (-40 °F +212 °F)
air max T = +70 °C (+160 °F)**Safety factor:** 1:4**Length:** random

Item Code	↔			↔		↻		↻		↷		♻	
	Dash	mm	in	mm	in	Mpa	psi	Mpa	psi	mm	in	kg/m	lb/ft
1000365	04	6,0	1/4"	13,00	0,51	40,0	5850	160,0	23200	75,0	2,95	0,255	0,18
1000366	05	8,0	5/16"	14,70	0,58	35,0	5000	140,0	20000	85,0	3,35	0,300	0,21
1000367	06	10,0	3/8"	16,50	0,65	33,0	4800	132,0	19200	90,0	3,54	0,370	0,25
1000368	08	13,0	1/2"	19,90	0,78	27,5	4000	110,0	16000	130,0	5,12	0,470	0,32
1000369	10	16,0	5/8"	23,40	0,92	25,0	3630	100,0	14500	170,0	6,69	0,591	0,40
1000370	12	19,0	3/4"	27,60	1,09	21,5	3120	86,0	12500	200,0	7,87	0,789	0,54
1000371	16	25,0	1"	34,90	1,37	16,5	2400	66,0	9600	250,0	9,84	1,155	0,78

// FLEXOPAK 2 - MINETUFF



ISO 11237 - SAE 100 R16 - EN 857 2SC (up to 1")

Tube: oil resistant synthetic rubber.
Reinforcement: two high tensile steel braids.
Cover: abrasion, ozone and hydrocarbon resistant synthetic rubber.

MSHA APPROVED

Application: high pressure hydraulic lines, fuel oil, antifreeze solutions, air and water.

Constant operation: -40 °C +100 °C (-40 °F +212 °F)
 air max T = +70 °C (+160 °F)

Safety factor: 1:4

Length: random up to 1" - 61 m max over 1"1/4

Item Code	↔			↔		↻		↻		↷		⚖	
	Dash	mm	in	mm	in	Mpa	psi	Mpa	psi	mm	in	kg/m	lb/ft
1000146	04	6,0	1/4"	13,00	0,51	42,0	6000	168,0	24000	51,0	2,01	0,259	0,18
1000174	05	8,0	5/16"	14,50	0,57	37,5	5500	150,0	22000	57,0	2,24	0,313	0,22
1000147	06	10,0	3/8"	16,80	0,66	35,0	5000	140,0	20000	64,0	2,52	0,373	0,26
1000171	08	13,0	1/2"	20,60	0,81	31,0	4500	124,0	18000	90,0	3,54	0,508	0,35
1000104	10	16,0	5/8"	23,20	0,91	28,0	4000	112,0	16000	101,0	3,98	0,595	0,40
1000172	12	19,0	3/4"	27,60	1,09	24,0	3500	96,0	14000	121,0	4,76	0,781	0,53
1000173	16	25,0	1"	35,50	1,40	21,0	3000	84,0	12000	152,0	5,98	1,266	0,86
1001533	20	32,0	1 1/4"	42,00	1,65	14,0	2000	58,0	8400	210,0	8,27	1,367	0,92
1001728	24	38,0	1 1/2"	49,90	1,96	12,5	1820	50,0	7280	430,0	16,93	1,970	1,33
1001729	32	51,0	2"	63,50	2,50	10,0	1500	40,0	5850	550,0	21,65	2,550	1,72
1001945	40	63,0	2 1/2"	76,40	3,01	7,5	1100	30,0	4300	720,0	28,35	3,300	2,22

// FLEXOR 2SN/R2AT (HF)



ISO 1436-1 - SAE 100 R2AT - EN 853 2SN

Tube: oil resistant synthetic rubber.
Reinforcement: two high tensile steel braids.
Cover: abrasion, ozone and hydrocarbon resistant synthetic rubber.

Application: high pressure hydraulic lines, fuel oil, antifreeze solutions, air and water.

HALOGEN-FREE COMPOUND

Constant operation: -40 °C +100 °C (-40 °F +212 °F)
 air max T = +70 °C (+160 °F)

Safety factor: 1:4

Length: random up to 1" - 61 m max over 1"1/4

Item Code	↔			↔		↻		↻		↷		⚖	
	Dash	mm	in	mm	in	Mpa	psi	Mpa	psi	mm	in	kg/m	lb/ft
1001341	03	5,0	3/16"	13,00	0,51	42,0	6000	168,0	24000	90,0	3,54	0,282	0,19
1001342	04	6,0	1/4"	14,20	0,56	40,0	5850	160,0	23200	100,0	3,94	0,330	0,23
1001343	05	8,0	5/16"	15,80	0,62	35,0	5000	140,0	20000	115,0	4,53	0,357	0,24
1001344	06	10,0	3/8"	18,20	0,72	33,0	4800	132,0	19200	125,0	4,92	0,460	0,31
1001345	08	13,0	1/2"	21,30	0,84	27,5	4000	110,0	16000	175,0	6,89	0,534	0,36
1001346	10	16,0	5/8"	24,50	0,96	25,0	3630	100,0	14500	200,0	7,87	0,670	0,46
1001347	12	19,0	3/4"	28,60	1,13	21,5	3120	86,0	12500	240,0	9,45	0,846	0,57
1001348	16	25,0	1"	36,60	1,44	16,5	2400	66,0	9600	300,0	11,81	1,250	0,85
1001349	20	32,0	1 1/4"	46,00	1,81	12,5	1820	50,0	7280	420,0	16,54	1,540	1,04
1001350	24	38,0	1 1/2"	52,80	2,08	9,0	1310	36,0	5240	500,0	19,69	2,030	1,37
1001351	32	51,0	2"	65,60	2,58	8,0	1200	32,0	4640	630,0	24,80	2,760	1,86

Dimensions shown may be changed without prior notice

// FLEXOR 2SN/R2AT - MINETUFF



ISO 1436-1 - SAE 100 R2AT - EN 853 2SN

Tube: oil resistant synthetic rubber.**Reinforcement:** two high tensile steel braids.**Cover:** abrasion, ozone and hydrocarbon resistant synthetic rubber.**MSHA APPROVED****Application:** high pressure hydraulic lines, fuel oil, antifreeze solutions, air and water.**Constant operation:** -40 °C +100 °C (-40 °F +212 °F)
air max T = +70 °C (+160 °F)**Safety factor:** 1:4**Length:** random up to 1" - 61 m max over 1"1/4

Item Code	Dash	↔		↔		↻		↻		⤴		⚖	
		mm	in	mm	in	Mpa	psi	Mpa	psi	mm	in	kg/m	lb/ft
1002467	04	6,0	1/4"	14,20	0,56	40,0	5850	160,0	23200	100,0	3,94	0,330	0,23
1002468	05	8,0	5/16"	15,80	0,62	35,0	5000	140,0	20000	115,0	4,53	0,353	0,24
1002469	06	10,0	3/8"	18,20	0,72	33,0	4800	132,0	19200	125,0	4,92	0,463	0,32
1002470	08	13,0	1/2"	21,30	0,84	27,5	4000	110,0	16000	175,0	6,89	0,530	0,36
1002471	10	16,0	5/8"	24,50	0,96	25,0	3630	100,0	14500	200,0	7,87	0,674	0,46
1002472	12	19,0	3/4"	28,60	1,13	21,5	3120	86,0	12500	240,0	9,45	0,852	0,58
1002473	16	25,0	1"	36,60	1,44	16,5	2400	66,0	9600	300,0	11,81	1,224	0,83
1002498	20	32,0	1 1/4"	46,00	1,81	12,5	1820	50,0	7280	420,0	16,54	1,769	1,19
1002474	24	38,0	1 1/2"	52,80	2,08	9,0	1310	36,0	5240	500,0	19,69	2,030	1,37
1002475	32	51,0	2"	65,60	2,58	8,0	1200	32,0	4640	630,0	24,80	2,760	1,86

// FLEXOR ELEVATOR



EN 81.2

Tube: oil resistant synthetic rubber.**Reinforcement:** one/two high tensile steel braids.**Cover:** abrasion, ozone and hydrocarbon resistant synthetic rubber.**Application:** medium pressure hydraulic lines, fuel oil, antifreeze solutions, air and water.**Constant operation:** -40 °C +100 °C (-40 °F +212 °F)
air max T = +70 °C (+160 °F)**Safety factor:** 1:8**Length:** random

Item Code	Const.	↔		↔		↻		↻		⤴		⚖		
		Dash	mm	in	mm	in	Mpa	psi	Mpa	psi	mm	in	kg/m	lb/ft
1001782	1WB	12	19,0	3/4"	25,80	1,02	5,0	730	40,0	5850	240,0	9,45	0,490	0,33
1000941	1WB	16	25,0	1"	32,10	1,26	5,0	730	40,0	5850	300,0	11,81	0,650	0,44
1000943	1WB	20	32,0	1 1/4"	39,50	1,56	5,0	730	40,0	5850	420,0	16,54	1,000	0,68
1000972	2WB	24	38,0	1 1/2"	48,80	1,92	5,0	730	40,0	5850	500,0	19,69	1,530	1,03
1001781	2WB	32	51,0	2"	62,80	2,47	5,0	730	40,0	5850	630,0	24,80	2,220	1,50

// ALFAFOREST



Tube: oil resistant synthetic rubber.

Reinforcement: three high tensile steel braids.

Cover: abrasion, ozone and hydrocarbon resistant synthetic rubber.

Application: high pressure hydraulic lines, fuel oil, antifreeze solutions, air and water.

Constant operation: -40 °C +100 °C (-40 °F +212 °F)
air max T = +70 °C (+160 °F)

Safety factor: 1:4

Length: random

Item Code	↔			↔		↙		↘		∩		⊞	
	Dash	mm	in	mm	in	Mpa	psi	Mpa	psi	mm	in	kg/m	lb/ft
1003800	06	10,0	3/8"	21,70	0,85	50,0	7280	196,0	28000	120,0	4,72	0,760	0,52
1003803	08	13,0	1/2"	24,80	0,98	46,9	6800	188,0	27200	160,0	6,30	0,880	0,60
1003316	10	16,0	5/8"	28,30	1,11	41,4	6000	164,0	23500	210,0	8,27	1,110	0,75
1003317	12	19,0	3/4"	32,20	1,27	37,5	5500	150,0	22000	260,0	10,24	1,380	0,93
1003318	16	25,0	1"	40,40	1,59	33,0	4800	130,8	19000	310,0	12,20	2,100	1,42
1003804	20	32,0	1 1/4"	45,90	1,81	24,0	3500	96,0	14000	410,0	16,14	2,310	1,56

Dimensions shown may be changed without prior notice

// WIRE SPIRAL

// BOP - FIRESAFE 5000



API 16-D FLAME RESISTANCE

Tube: oil resistant synthetic rubber.**Reinforcement:** four/six high tensile steel spirals.**Cover:** oil and fire resistant red synthetic rubber.**MSHA APPROVED****Application:** high pressure hydraulic lines in blow out preventer system, where continuous operation in case of fire is required.**Constant operation:** -40 °C +121 °C (-40 °F +250 °F)**Safety factor:** 1:4**Length:** random up to 1" - 61 m max over 1"1/4

LLOYD'S type approval on hose assemblies

Item Code	Const.	↔			↔		↻		↻		↷		⚖	
		Dash	mm	in	mm	in	Mpa	psi	Mpa	psi	mm	in	kg/m	lb/ft
1001250	4WS	06	10,0	3/8"	28,10	1,11	35,0	5000	140,0	20000	180,0	7,09	1,134	0,77
1001244	4WS	08	13,0	1/2"	31,00	1,22	35,0	5000	140,0	20000	230,0	9,06	1,280	0,87
1001249	4WS	12	19,0	3/4"	38,80	1,53	35,0	5000	140,0	20000	300,0	11,81	1,860	1,26
1001243	4WS	16	25,0	1"	46,00	1,81	35,0	5000	140,0	20000	340,0	13,39	2,690	1,81
1001247	4WS	20	32,0	1 1/4"	53,10	2,09	35,0	5000	140,0	20000	460,0	18,11	3,340	2,25
1001246	6WS	24	38,0	1 1/2"	64,90	2,56	35,0	5000	140,0	20000	560,0	22,05	5,870	3,95
1001248	6WS	32	51,0	2"	78,70	3,10	35,0	5000	140,0	20000	700,0	27,56	7,780	5,23

// FLEXOR 4SP



EN 856 4SP

Tube: oil resistant synthetic rubber.**Reinforcement:** four high tensile steel spirals.**Cover:** abrasion, ozone and hydrocarbon resistant synthetic rubber.**MSHA APPROVED****Application:** very high pressure hydraulic lines, fuel oil, antifreeze solutions, air and water.**Constant operation:** -40 °C +100 °C (-40 °F +212 °F)**Safety factor:** 1:4**Length:** random**Notes:** specification reference: SAE 100 R15 (1/1, 3/8, 1/2)

Item Code	↔			↔		↻		↻		↷		⚖	
	Dash	mm	in	mm	in	Mpa	psi	Mpa	psi	mm	in	kg/m	lb/ft
1000236	04	6,0	1/4"	17,90	0,70	45,0	6550	180,0	26200	150,0	5,91	0,547	0,37
1000237	06	10,0	3/8"	21,40	0,84	44,5	6450	178,0	25800	180,0	7,09	0,706	0,48
1000238	08	13,0	1/2"	24,60	0,97	41,5	6000	166,0	24000	230,0	9,06	0,864	0,59
1000239	10	16,0	5/8"	28,20	1,11	35,0	5000	140,0	20000	250,0	9,84	1,037	0,70
1000240	12	19,0	3/4"	32,20	1,27	38,0	5500	152,0	22040	300,0	11,81	1,434	0,97
1000241	16	25,0	1"	39,70	1,56	32,0	4640	128,0	18560	340,0	13,39	1,880	1,27

// FLEXOR 4SH



EN 856 4SH

Tube: oil resistant synthetic rubber.

Reinforcement: four high tensile steel spirals.

Cover: abrasion, ozone and hydrocarbon resistant synthetic rubber.

MSHA APPROVED

Application: very high pressure hydraulic lines, fuel oil, antifreeze solutions, air and water.

Constant operation: -40 °C +100 °C (-40 °F +212 °F)

Safety factor: 1:4

Length: random up to 1" - 61 m max over 1"1/4

Item Code	↔			↔		↕		↕		∩		⊞	
	Dash	mm	in	mm	in	Mpa	psi	Mpa	psi	mm	in	kg/m	lb/ft
1000245	12	19,0	3/4"	32,20	1,27	42,0	6000	168,0	24000	280,0	11,02	1,556	1,05
1000246	16	25,0	1"	38,70	1,52	38,0	5500	152,0	22040	340,0	13,39	1,950	1,32
1000247	20	32,0	1 1/4"	45,50	1,79	35,0	5000	140,0	20000	460,0	18,11	2,470	1,66
1000248	24	38,0	1 1/2"	53,50	2,11	29,0	4200	116,0	16800	560,0	22,05	3,270	2,20
1000249	32	51,0	2"	68,10	2,68	25,0	3630	100,0	14500	700,0	27,56	4,670	3,14

// FLEXOR 12



SAE 100 R12 - EN 856 R12

Tube: oil resistant synthetic rubber.

Reinforcement: four high tensile steel spirals.

Cover: abrasion, ozone and hydrocarbon resistant synthetic rubber.

MSHA APPROVED

Application: very high pressure hydraulic lines, fuel oil, antifreeze solutions, air and water.

Constant operation: -40 °C +121 °C (-40 °F +250 °F)

Safety factor: 1:4

Length: random up to 1" - 61 m max over 1"1/4

Item Code	↔			↔		↕		↕		∩		⊞	
	Dash	mm	in	mm	in	Mpa	psi	Mpa	psi	mm	in	kg/m	lb/ft
1000463	06	10,0	3/8"	20,30	0,80	28,0	4000	112,0	16000	127,0	5,00	0,610	0,41
1000464	08	13,0	1/2"	23,80	0,94	28,0	4000	112,0	16000	178,0	7,01	0,760	0,52
1000465	10	16,0	5/8"	27,40	1,08	28,0	4000	112,0	16000	203,0	7,99	1,020	0,69
1000343	12	19,0	3/4"	30,70	1,21	28,0	4000	112,0	16000	241,0	9,49	1,190	0,80
1000342	16	25,0	1"	38,00	1,50	28,0	4000	112,0	16000	305,0	12,01	1,730	1,17
1000341	20	32,0	1 1/4"	47,00	1,85	21,0	3000	84,0	12000	419,0	16,50	2,690	1,81
1000340	24	38,0	1 1/2"	53,50	2,11	17,5	2500	70,0	10000	508,0	20,00	3,080	2,07
1000339	32	51,0	2"	66,70	2,63	17,5	2500	70,0	10000	635,0	25,00	3,970	2,67
1000882	40	63,0	2 1/2"	81,20	3,20	14,0	2000	56,0	8000	720,0	28,35	6,360	4,28

Dimensions shown may be changed without prior notice

// FLEXOR 13



SAE 100 R13 - EN 856 R13

Tube: oil resistant synthetic rubber.**Reinforcement:** four/six high tensile steel spirals.**Cover:** abrasion, ozone and hydrocarbon resistant synthetic rubber.**MSHA APPROVED****Application:** very high pressure hydraulic lines, fuel oil, antifreeze solutions, air and water.**Constant operation:** -40 °C +121 °C (-40 °F +250 °F)**Safety factor:** 1:4**Length:** random up to 1" - 61 m max over 1"1/4

Item Code	Const.	↔			↔		↻		↻		↷		⚖	
		Dash	mm	in	mm	in	Mpa	psi	Mpa	psi	mm	in	kg/m	lb/ft
1000231	4WS	16	25,0	1"	38,70	1,52	38,0	5500	152,0	22040	305,0	12,01	2,000	1,35
1000232	6WS	20	32,0	1 1/4"	49,80	1,96	35,0	5000	140,0	20000	419,0	16,50	3,600	2,42
1000233	6WS	24	38,0	1 1/2"	57,30	2,26	35,0	5000	140,0	20000	508,0	20,00	4,800	3,23
1000234	6WS	32	51,0	2"	70,90	2,79	35,0	5000	140,0	20000	635,0	25,00	6,600	4,44

// FLEXOR 15 - MINETUFF



SAE 100 R15

Tube: oil resistant synthetic rubber.**Reinforcement:** four/six high tensile steel spirals.**Cover:** abrasion, ozone and hydrocarbon resistant synthetic rubber.**MSHA APPROVED****Application:** very high pressure hydraulic lines, fuel oil, antifreeze solutions, air and water.**Constant operation:** -40 °C +121 °C (-40 °F +250 °F)**Safety factor:** 1:4**Length:** random up to 1" - 61 m max over 1"1/4

Item Code	Const.	↔			↔		↻		↻		↷		⚖	
		Dash	mm	in	mm	in	Mpa	psi	Mpa	psi	mm	in	kg/m	lb/ft
1000254	4WS	10	16,0	5/8"	28,40	1,12	42,0	6000	168,0	24000	250,0	9,84	1,270	0,86
1000179	4WS	16	25,0	1"	38,70	1,52	42,0	6000	168,0	24000	330,0	12,99	2,200	1,48
1000180	6WS	20	32,0	1 1/4"	49,80	1,96	42,0	6000	168,0	24000	445,0	17,52	3,590	2,42
1000189	6WS	24	38,0	1 1/2"	57,30	2,26	42,0	6000	168,0	24000	530,0	20,87	5,000	3,37
1000344	6WS	32	51,0	2"	72,00	2,83	42,0	6000	168,0	24000	635,0	25,00	7,080	4,76

// AT7K - MINETUFF



Tube: oil resistant synthetic rubber.

Reinforcement: four high tensile steel spirals.

Cover: abrasion, ozone and hydrocarbon resistant synthetic rubber.

MSHA APPROVED

Application: very high pressure hydraulic lines, fuel oil, antifreeze solutions, air and water.

Constant operation: -40 °C +121 °C (-40 °F +250 °F)

Safety factor: 1:4

Length: random up to 5/8" - 61 m max over 1"1/4

Item Code	Const.	↔			↔		↻		↻		⤴		⏪	
		Dash	mm	in	mm	in	Mpa	psi	Mpa	psi	mm	in	kg/m	lb/ft
1000275	4WS	10	16,0	5/8"	29,40	1,16	49,0	7000	196,0	28000	250,0	9,84	1,320	0,89

// AT8K - MINETUFF



Tube: oil resistant synthetic rubber.

Reinforcement: four high tensile steel spirals.

Cover: abrasion, ozone and hydrocarbon resistant synthetic rubber.

MSHA APPROVED

Application: very high pressure hydraulic lines, fuel oil, antifreeze solutions, air and water.

Constant operation: -40 °C +121 °C (-40 °F +250 °F)

Safety factor: 1:4

Length: random

Item Code	↔			↔		↻		↻		⤴		⏪	
	Dash	mm	in	mm	in	Mpa	psi	Mpa	psi	mm	in	kg/m	lb/ft
1003064	12	19,0	3/4"	31,80	1,25	56,0	8000	224,0	32000	270,0	10,63	1,710	1,15
1003066	16	25,0	1"	39,40	1,55	56,0	8000	224,0	32000	300,0	11,81	2,471	1,67

ALFAGOMMA

alfabiotech

**NEW EXTRA FLEXIBLE
BIO OIL RESISTANT
HOSE RANGE**



alfabiotech

- ▲ SPECIALLY DESIGNED FOR BIO OIL FULL COMPATIBILITY
- ▲ EXTREME FLEXIBILITY: UP TO 50% BETTER BEND RADIUS COMPARED TO SAE 100R
- ▲ MINETUFF COVER FOR TOP ABRASION & OZONE RESISTANCE
- ▲ MSHA-APPROVED FIRE RESISTANT COVER



BEND RADIUS
STANDARD SAE 100R

BEND RADIUS: REDUCED UP TO 50%

www.alfagomma.com

EN 856 R12 - MSHA

// ALFABIOTECH

// ALFABIOTECH 2000 - MINETUFF



ISO 18752

Tube: oil resistant synthetic rubber and biodegradable hydraulic fluids.

Reinforcement: four high tensile steel spirals.

Cover: abrasion, ozone and hydrocarbon resistant synthetic rubber.

MSHA APPROVED

Application: developed to withstand very demanding conditions, very high performance in pressure, pulsing and flexing.

Constant operation: -40 °C +121 °C (-40 °F +250 °F)

Safety factor: 1:4

Length: 61 m from 1 1/4" to 3"

Item Code	↔			↔		↻		↻		⤴		⚖	
	Dash	mm	in	mm	in	Mpa	psi	Mpa	psi	mm	in	kg/m	lb/ft
1002575	40	63,0	2 1/2"	79,00	3,11	14,0	2000	56,0	8000	720,0	28,35	4,630	3,12
1002576	48	76,0	3"	92,50	3,64	14,0	2000	56,0	8000	840,0	33,07	5,404	3,64

// ALFABIOTECH 3000 - MINETUFF

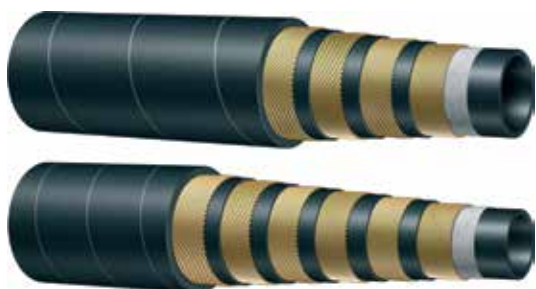

ISO 18752 - EXCEEDS SAE 100 R12

Tube: oil resistant synthetic rubber and biodegradable hydraulic fluids.

Reinforcement: four/six high tensile steel spirals.

Cover: abrasion, ozone and hydrocarbon resistant synthetic rubber.

MSHA APPROVED

Application: developed to withstand very demanding conditions, very high performance in pressure, pulsing and flexing.

Constant operation: -40 °C +121 °C (-40 °F +250 °F)

Safety factor: 1:4

Length: 61 m from 1 1/4" to 3"

Item Code	Const.	↔			↔		↻		↻		⤴		⚖	
		Dash	mm	in	mm	in	Mpa	psi	Mpa	psi	mm	in	kg/m	lb/ft
1001690	4WS	20	32,0	1 1/4"	45,70	1,80	21,0	3000	84,0	12000	230,0	9,06	2,259	1,52
1002574	4WS	24	38,0	1 1/2"	51,80	2,04	21,0	3000	84,0	12000	420,0	16,54	2,758	1,86
1003035	4WS	32	51,0	2"	66,80	2,63	21,0	3000	84,0	12000	560,0	22,05	3,989	2,69
1003036	6WS	48	76,0	3"	95,60	3,76	21,0	3000	84,0	12000	900,0	35,43	7,950	5,35

Dimensions shown may be changed without prior notice

// ALFABIOTECH 4000 - MINETUFF



ISO 18752

Tube: oil resistant synthetic rubber and biodegradable hydraulic fluids.

Reinforcement: four high tensile steel spirals.

Cover: abrasion, ozone and hydrocarbon resistant synthetic rubber.

MSHA APPROVED

Application: developed to withstand very demanding conditions, very high performance in pressure, pulsing and flexing.

Constant operation: -40 °C +121 °C (-40 °F +250 °F)

Safety factor: 1:4

Length: random up to 1" - 61 m max over 1"1/4

Item Code	Dash	↔		↔		↻		↻		⤴		⚖	
		mm	in	mm	in	Mpa	psi	Mpa	psi	mm	in	kg/m	lb/ft
1003797	08	13,0	1/2"	23,00	0,91	28,0	4000	112,0	16000	90,0	3,54	0,747	0,51
1001691	12	19,0	3/4"	29,50	1,16	28,0	4000	112,0	16000	120,0	4,72	1,019	0,69
1001692	16	25,0	1"	37,50	1,48	28,0	4000	112,0	16000	150,0	5,91	1,637	1,11
1002484	20	32,0	1 1/4"	45,70	1,80	28,0	4000	112,0	16000	260,0	10,24	2,264	1,53
1002483	32	51,0	2"	66,80	2,63	28,0	4000	112,0	16000	530,0	20,87	4,475	3,01

// ALFABIOTECH 5000 - MINETUFF

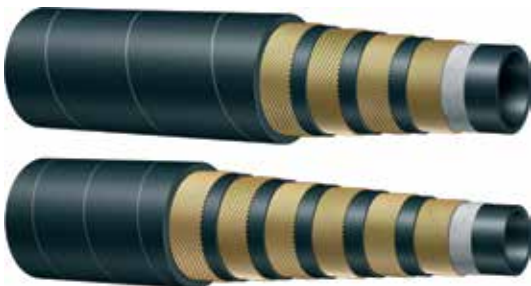

ISO 18752

Tube: oil resistant synthetic rubber and biodegradable hydraulic fluids.

Reinforcement: four/six high tensile steel spirals.

Cover: abrasion, ozone and hydrocarbon resistant synthetic rubber.

MSHA APPROVED

Application: developed to withstand very demanding conditions, very high performance in pressure, pulsing and flexing.

Constant operation: -40 °C +121 °C (-40 °F +250 °F)

Safety factor: 1:4

Length: random up to 1" - 61 m max over 1"1/4

Item Code	Const.	↔			↔		↻		↻		⤴		⚖	
		Dash	mm	in	mm	in	Mpa	psi	Mpa	psi	mm	in	kg/m	lb/ft
1001693	4WS	10	16,0	5/8"	26,30	1,04	35,0	5000	140,0	20000	140,0	5,51	0,931	0,63
1001694	4WS	12	19,0	3/4"	31,00	1,22	35,0	5000	140,0	20000	150,0	5,91	1,230	0,83
1001695	4WS	16	25,0	1"	37,60	1,48	35,0	5000	140,0	20000	180,0	7,09	1,680	1,13
1001696	4WS	20	32,0	1 1/4"	45,80	1,80	35,0	5000	140,0	20000	280,0	11,02	2,521	1,70
1001780	6WS	24	38,0	1 1/2"	56,50	2,22	35,0	5000	140,0	20000	500,0	19,69	4,483	3,02
1001779	6WS	32	51,0	2"	70,20	2,76	35,0	5000	140,0	20000	550,0	21,65	6,159	4,14

// ALFABIOTECH 5000 PLUS - MINETUFF



ISO 18752

Tube: oil resistant synthetic rubber and biodegradable hydraulic fluids.

Reinforcement: four high tensile steel spirals.

Cover: abrasion, ozone and hydrocarbon resistant synthetic rubber.

MSHA APPROVED

Application: developed to withstand very demanding conditions, very high performance in pressure, pulsing and flexing.

Constant operation: -40 °C +121 °C (-40 °F +250 °F)

Safety factor: 1:4

Length: random

Item Code	↔			↔		↻		↻		⤴		⚖	
	Dash	mm	in	mm	in	Mpa	psi	Mpa	psi	mm	in	kg/m	lb/ft
1001712	12	19,0	3/4"	31,00	1,22	38,0	5500	152,0	22040	180,0	7,09	1,324	0,89
1001713	16	25,0	1"	38,30	1,51	38,0	5500	152,0	22040	210,0	8,27	1,923	1,30

// ALFABIOTECH 6000 - MINETUFF



ISO 18752 - EXCEEDS SAE 100 R15

Tube: oil resistant synthetic rubber and biodegradable hydraulic fluids.

Reinforcement: four/six high tensile steel spirals.

Cover: abrasion, ozone and hydrocarbon resistant synthetic rubber.

MSHA APPROVED

Application: developed to withstand very demanding conditions, very high performance in pressure, pulsing and flexing.

Constant operation: -40 °C +121 °C (-40 °F +250 °F)

Safety factor: 1:4

Length: random up to 1" - 61 m max over 1"1/4

Item Code	Const.	↔			↔		↻		↻		⤴		⚖	
		Dash	mm	in	mm	in	Mpa	psi	Mpa	psi	mm	in	kg/m	lb/ft
1001697	4WS	04	6,0	1/4"	17,30	0,68	45,0	6550	180,0	26200	60,0	2,36	0,540	0,37
1001698	4WS	06	10,0	3/8"	20,10	0,79	44,5	6450	178,0	25800	75,0	2,95	0,648	0,44
1001699	4WS	08	13,0	1/2"	23,00	0,91	42,0	6000	168,0	24000	90,0	3,54	0,747	0,51
1001700	4WS	10	16,0	5/8"	28,20	1,11	42,0	6000	168,0	24000	180,0	7,09	1,198	0,81
1001701	4WS	12	19,0	3/4"	31,40	1,24	42,0	6000	168,0	24000	210,0	8,27	1,429	0,97
1001702	4WS	16	25,0	1"	38,20	1,50	42,0	6000	168,0	24000	250,0	9,84	1,950	1,32
1002487	4WS	20	32,0	1 1/4"	46,10	1,81	42,0	6000	168,0	24000	445,0	17,52	2,920	1,97
1002485	6WS	20	32,0	1 1/4"	49,30	1,94	42,0	6000	168,0	24000	445,0	17,52	3,401	2,29
1002486	6WS	24	38,0	1 1/2"	56,50	2,22	42,0	6000	168,0	24000	530,0	20,87	4,480	3,02
1003505	6WS	32	51,0	2"	71,00	2,80	42,0	6000	168,0	24000	650,0	25,59	6,500	4,37

Dimensions shown may be changed without prior notice

// SUPERTUFF

// AT3K - SUPERTUFF



ISO 11237 - SAE 100 R17 - EN 857 1SC

Tube: oil resistant synthetic rubber.**Reinforcement:** one high tensile steel braid.**Cover:** abrasion, ozone and hydrocarbon resistant synthetic rubber. Special "supertuff" cover for excellent abrasion resistance and long service life in heavy duty applications.**MSHA APPROVED****Application:** high pressure hydraulic lines, fuel oil, antifreeze solutions, air and water.**Constant operation:** -40 °C +100 °C (-40 °F +212 °F)

air max T = +70 °C (+160 °F)

Safety factor: 1:4**Length:** random

Item Code	↔			↔		↻		↻		↷		♻	
	Dash	mm	in	mm	in	Mpa	psi	Mpa	psi	mm	in	kg/m	lb/ft
1000195	04	6,0	1/4"	12,10	0,48	22,5	3250	90,0	13000	50,0	1,97	0,170	0,12
1000405	05	8,0	5/16"	14,00	0,55	21,5	3120	86,0	12500	55,0	2,17	0,180	0,13
1000209	06	10,0	3/8"	15,60	0,61	21,0	3000	84,0	12000	65,0	2,56	0,260	0,18
1000197	08	13,0	1/2"	19,50	0,77	21,0	3000	84,0	12000	90,0	3,54	0,410	0,28

// FLEXOPAK 2 - SUPERTUFF



ISO 11237 - SAE 100 R16 - EN 857 2SC

Tube: oil resistant synthetic rubber.**Reinforcement:** two high tensile steel braids.**Cover:** abrasion, ozone and hydrocarbon resistant synthetic rubber. Special "supertuff" cover for excellent abrasion resistance and long service life in heavy duty applications.**MSHA APPROVED****Application:** high pressure hydraulic lines, fuel oil, antifreeze solutions, air and water.**Constant operation:** -40 °C +100 °C (-40 °F +212 °F)

air max T = +70 °C (+160 °F)

Safety factor: 1:4**Length:** random

Item Code	↔			↔		↻		↻		↷		♻	
	Dash	mm	in	mm	in	Mpa	psi	Mpa	psi	mm	in	kg/m	lb/ft
1000228	04	6,0	1/4"	13,00	0,51	42,0	6000	168,0	24000	51,0	2,01	0,270	0,19
1000213	05	8,0	5/16"	14,50	0,57	37,5	5500	150,0	22000	57,0	2,24	0,320	0,22
1000224	06	10,0	3/8"	16,80	0,66	35,0	5000	140,0	20000	64,0	2,52	0,393	0,27
1000225	08	13,0	1/2"	20,60	0,81	31,0	4500	124,0	18000	90,0	3,54	0,528	0,36
1000226	10	16,0	5/8"	23,20	0,91	28,0	4000	112,0	16000	101,0	3,98	0,614	0,42
1000227	12	19,0	3/4"	27,60	1,09	24,0	3500	96,0	14000	125,0	4,92	0,822	0,56
1000348	16	25,0	1"	35,50	1,40	21,0	3000	84,0	12000	150,0	5,91	1,300	0,88

// ALFABIOTECH 5000 - SUPERTUFF



ISO 18752

Tube: oil resistant synthetic rubber and biodegradable hydraulic fluids.

Reinforcement: four/six high tensile steel spirals.

Cover: abrasion, ozone and hydrocarbon resistant synthetic rubber. Special "supertuff" cover for excellent abrasion resistance and long service life in heavy duty applications.

MSHA APPROVED

Application: developed to withstand very demanding conditions, very high performance in pressure, pulsing and flexing.

Constant operation: -40 °C +121 °C (-40 °F +250 °F)

Safety factor: 1:4

Length: random up to 1" - 61 m max over 1"1/4

Item Code	Const.	↔			↔		↻		↻		⤴		⚖	
		Dash	mm	in	mm	in	Mpa	psi	Mpa	psi	mm	in	kg/m	lb/ft
1003045	4WS	10	16,0	5/8"	26,00	1,02	35,0	5000	140,0	20000	140,0	5,51	0,930	0,63
1003037	4WS	12	19,0	3/4"	31,60	1,24	35,0	5000	140,0	20000	150,0	5,91	1,293	0,87
1003038	4WS	16	25,0	1"	38,20	1,50	35,0	5000	140,0	20000	180,0	7,09	1,704	1,15
1003046	4WS	20	32,0	1 1/4"	44,40	1,75	35,0	5000	140,0	20000	280,0	11,02	2,984	2,01
1003047	6WS	24	38,0	1 1/2"	56,50	2,22	35,0	5000	140,0	20000	500,0	19,69	4,610	3,10
1003048	6WS	32	51,0	2"	70,20	2,76	35,0	5000	140,0	20000	550,0	21,65	6,376	4,29

// ALFABIOTECH 6000 - SUPERTUFF

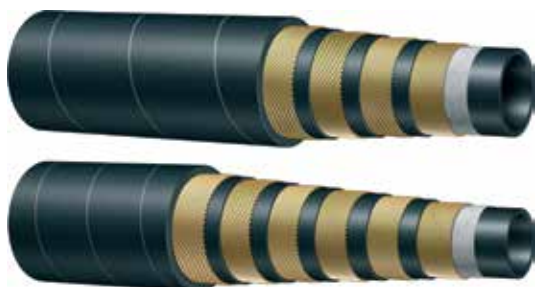

ISO 18752 - EXCEEDS SAE 100 R15

Tube: oil resistant synthetic rubber and biodegradable hydraulic fluids.

Reinforcement: four/six high tensile steel spirals.

Cover: abrasion, ozone and hydrocarbon resistant synthetic rubber. Special "supertuff" cover for excellent abrasion resistance and long service life in heavy duty applications.

MSHA APPROVED

Application: developed to withstand very demanding conditions, very high performance in pressure, pulsing and flexing.

Constant operation: -40 °C +121 °C (-40 °F +250 °F)

Safety factor: 1:4

Length: random up to 1" - 61 m max over 1"1/4

Item Code	Const.	↔			↔		↻		↻		⤴		⚖	
		Dash	mm	in	mm	in	Mpa	psi	Mpa	psi	mm	in	kg/m	lb/ft
1003296	4WS	06	10,0	3/8"	20,10	0,79	44,5	6450	178,0	25800	75,0	2,95	0,674	0,46
1003233	4WS	08	13,0	1/2"	23,00	0,91	42,0	6000	168,0	24000	90,0	3,54	0,750	0,51
1002464	4WS	10	16,0	5/8"	28,20	1,11	42,0	6000	168,0	24000	180,0	7,09	1,198	0,81
1003297	4WS	12	19,0	3/4"	31,40	1,24	42,0	6000	168,0	24000	210,0	8,27	1,470	0,99
1002572	4WS	16	25,0	1"	38,20	1,50	42,0	6000	168,0	24000	250,0	9,84	2,030	1,37
1003298	6WS	20	32,0	1 1/4"	49,30	1,94	42,0	6000	168,0	24000	445,0	17,52	3,470	2,34
1003299	6WS	24	38,0	1 1/2"	56,50	2,22	42,0	6000	168,0	24000	530,0	20,87	4,629	3,12

Dimensions shown may be changed without prior notice

// HIGH TEMPERATURE

// FLEXOPAK 2 HT



ISO 11237 - SAE 100 R16 - EN 857 2SC (up to 1")

Tube: oil resistant synthetic rubber.**Reinforcement:** two high tensile steel braids.**Cover:** abrasion, ozone and hydrocarbon resistant blue synthetic rubber.**MSHA APPROVED****Application:** high pressure hydraulic lines, fuel oil, antifreeze solutions, air and water. Specially designed for high temperature applications.**Constant operation:** -40 °C +135 °C (-40 °F +275 °F)

air max T = +70 °C (+160 °F)

Safety factor: 1:4**Length:** random

Item Code	↔			↔		↻		↻		↷		⚖	
	Dash	mm	in	mm	in	Mpa	psi	Mpa	psi	mm	in	kg/m	lb/ft
1002803	04	6,0	1/4"	13,40	0,53	42,0	6000	160,0	23200	51,0	2,01	0,260	0,18
1002804	05	8,0	5/16"	15,00	0,59	37,5	5500	150,0	22000	57,0	2,24	0,310	0,21
1002805	06	10,0	3/8"	17,40	0,69	35,0	5000	140,0	20000	64,0	2,52	0,390	0,27
1002806	08	13,0	1/2"	20,60	0,81	31,0	4500	124,0	18000	90,0	3,54	0,520	0,35
1002807	10	16,0	5/8"	23,70	0,93	28,0	4000	112,0	16000	101,0	3,98	0,600	0,41
1002808	12	19,0	3/4"	27,70	1,09	24,0	3500	96,0	14000	121,0	4,76	0,780	0,53
1002809	16	25,0	1"	35,60	1,40	21,0	3000	84,0	12000	152,0	5,98	1,230	0,83
1002810	20	32,0	1 1/4"	43,30	1,70	14,5	2100	58,0	8400	360,0	14,17	1,339	0,90
1002811	24	38,0	1 1/2"	49,90	1,96	12,5	1820	50,0	7280	430,0	16,93	1,857	1,25
1002812	32	51,0	2"	63,50	2,50	10,0	1500	40,0	5850	550,0	21,65	2,550	1,72
1002813	40	63,0	2 1/2"	76,40	3,01	7,5	1100	30,0	4300	720,0	28,35	3,300	2,22
1002814	48	76,0	3"	90,00	3,54	7,0	1000	28,0	4000	880,0	34,65	3,850	2,59

// TEMP TECH R5



SAE 100 R5

Tube: oil resistant synthetic rubber.**Reinforcement:** one high tensile steel braid.**Cover:** braided high tensile textile blue cord.**Application:** medium pressure hydraulic lines, fuel oil, antifreeze solutions, air and water. Specially designed for high temperature applications.**Constant operation:** -40 °C +150 °C (-40 °F +300 °F)

air max T = +110 °C (+230 °F)

Safety factor: 1:4**Length:** random

Item Code	↔			↔		↻		↻		↷		⚖	
	Dash	mm	in	mm	in	Mpa	psi	Mpa	psi	mm	in	kg/m	lb/ft
1002653	04	5,0	3/16"	13,20	0,52	20,7	3000	82,8	12000	76,0	2,99	0,230	0,16
1002654	05	6,3	1/4"	14,80	0,58	20,7	3000	82,8	12000	86,0	3,39	0,270	0,19
1002655	06	8,0	5/16"	17,30	0,68	15,5	2250	62,0	9000	102,0	4,02	0,350	0,24
1002656	08	11,0	7/16"	19,50	0,77	13,8	2000	55,2	8000	117,0	4,61	0,450	0,31
1002657	10	12,5	1/2"	23,40	0,92	12,1	1750	48,4	7000	140,0	5,51	0,560	0,38
1002658	12	16,0	5/8"	27,40	1,08	10,3	1500	41,4	6000	165,0	6,50	0,670	0,46
1002659	16	22,0	7/8"	31,40	1,24	5,5	800	22,0	3200	187,0	7,36	0,690	0,47
1002660	20	29,0	1 1/8"	38,10	1,50	4,3	625	17,2	2500	229,0	9,02	0,850	0,58
1002661	24	35,0	1 3/8"	44,50	1,75	3,4	525	13,8	2000	267,0	10,51	1,060	0,72
1002662	32	46,0	1 13/16"	56,40	2,22	2,4	350	9,6	1400	337,0	13,27	1,350	0,91

// TEMP TECH 1SN



ISO 1436-1 - SAE 100 R1AT - EN 853 1SN

Tube: oil resistant synthetic rubber.
Reinforcement: one high tensile steel braid.
Cover: abrasion, ozone and hydrocarbon resistant blue synthetic rubber.

MSHA APPROVED

Application: high pressure hydraulic lines, fuel oil, antifreeze solutions, air and water. Specially designed for high temperature applications. Not recommended for steam service.

Constant operation: -40 °C +150 °C (-40 °F +300 °F)
 air max T = +110 °C (+230 °F)

Safety factor: 1:4

Length: random up to 1" - 61 m max over 1"1/4

Item Code	↔			↔		↻		↻		↷		⚖	
	Dash	mm	in	mm	in	Mpa	psi	Mpa	psi	mm	in	kg/m	lb/ft
1000556	04	6,0	1/4"	13,40	0,53	22,5	3250	90,0	13000	100,0	3,94	0,213	0,15
1000332	06	10,0	3/8"	17,40	0,69	18,0	2610	72,0	10500	130,0	5,12	0,330	0,23
1000445	08	13,0	1/2"	20,60	0,81	16,0	2320	64,0	9280	180,0	7,09	0,420	0,29
1000360	10	16,0	5/8"	23,70	0,93	13,0	1900	52,0	7560	200,0	7,87	0,510	0,35
1000333	12	19,0	3/4"	27,70	1,09	10,5	1530	42,0	6000	240,0	9,45	0,651	0,44
1000361	16	25,0	1"	35,60	1,40	8,8	1280	35,2	5100	300,0	11,81	0,997	0,68
1000563	20	32,0	1 1/4"	43,50	1,71	6,3	920	25,2	3680	420,0	16,54	1,300	0,88
1000565	24	38,0	1 1/2"	50,60	1,99	5,0	730	20,0	2900	500,0	19,69	1,480	1,00
1001554	32	51,0	2"	64,00	2,52	4,0	600	16,0	2320	630,0	24,80	2,000	1,35

// TEMP TECH 2SN



ISO 1436-1 - SAE 100 R2AT - EN 853 2SN

Tube: oil resistant synthetic rubber.
Reinforcement: two high tensile steel braids.
Cover: abrasion, ozone and hydrocarbon resistant blue synthetic rubber.

MSHA APPROVED

Application: high pressure hydraulic lines, fuel oil, antifreeze solutions, air and water. Specially designed for high temperature applications. Not recommended for steam service.

Constant operation: -40 °C +150 °C (-40 °F +300 °F)
 air max T = +110 °C (+230 °F)

Safety factor: 1:4

Length: random up to 1" - 61 m max over 1"1/4

Item Code	↔			↔		↻		↻		↷		⚖	
	Dash	mm	in	mm	in	Mpa	psi	Mpa	psi	mm	in	kg/m	lb/ft
1000447	04	6,0	1/4"	15,00	0,59	40,0	5850	160,0	23200	100,0	3,94	0,360	0,25
1000334	06	10,0	3/8"	19,10	0,75	33,0	4800	132,0	19200	125,0	4,92	0,512	0,35
1000335	08	13,0	1/2"	22,20	0,87	28,0	4000	112,0	16000	175,0	6,89	0,640	0,44
1000349	10	16,0	5/8"	25,40	1,00	25,0	3630	100,0	14500	200,0	7,87	0,740	0,50
1000350	12	19,0	3/4"	29,30	1,15	21,5	3120	86,0	12500	240,0	9,45	0,932	0,63
1000351	16	25,0	1"	38,10	1,50	16,5	2400	66,0	9600	300,0	11,81	1,320	0,89
1000362	20	32,0	1 1/4"	48,30	1,90	12,5	1820	50,0	7280	420,0	16,54	1,930	1,30
1000352	24	38,0	1 1/2"	54,60	2,15	9,0	1310	36,0	5240	500,0	19,69	2,410	1,62
1000448	32	51,0	2"	67,40	2,65	8,0	1200	32,0	4640	630,0	24,80	2,960	1,99

Dimensions shown may be changed without prior notice

// LOW TEMPERATURE

// FLEXOPAK 2 LT



Tube: oil resistant ultra low temperature synthetic rubber.

Reinforcement: two high tensile steel braids.

Cover: oil, water, ozone and ultra low temperature resistant synthetic rubber.

Application: hydraulic system with petroleum or water/glycol based fluids, fuel, lubricating oils. Specially designed for ultra low temperature applications.

Constant operation: -55 °C +100 °C (-67 °F +212 °F)
air max T = +70 °C (+160 °F)

Safety factor: 1:4

Length: random

Item Code	↔			↔		↻		↻		↷		⚖	
	Dash	mm	in	mm	in	Mpa	psi	Mpa	psi	mm	in	kg/m	lb/ft
1003221	04	6,0	1/4"	13,00	0,51	42,0	6000	168,0	24000	51,0	2,01	0,280	0,19
1003283	05	8,0	5/16"	14,50	0,57	37,5	5500	150,0	22000	57,0	2,24	0,310	0,21
1003222	06	10,0	3/8"	16,80	0,66	35,0	5000	140,0	20000	64,0	2,52	0,390	0,27
1003226	08	13,0	1/2"	20,60	0,81	31,0	4500	124,0	18000	90,0	3,54	0,520	0,35
1003223	10	16,0	5/8"	23,40	0,92	28,0	4000	112,0	16000	101,0	3,98	0,600	0,41
1003224	12	19,0	3/4"	27,60	1,09	24,0	3500	96,0	14000	121,0	4,76	0,810	0,55
1003225	16	25,0	1"	35,50	1,40	21,0	3000	84,0	12000	152,0	5,98	1,220	0,82
1003304	20	32,0	1 1/4"	43,30	1,70	14,0	2000	58,0	8400	360,0	14,17	1,390	0,94

// ALFAFOREST LT



Tube: oil resistant ultra low temperature synthetic rubber.

Reinforcement: three high tensile steel braids.

Cover: oil, water, ozone and ultra low temperature resistant synthetic rubber.

Application: hydraulic system with petroleum or water/glycol based fluids, fuel, lubricating oils. Specially designed for ultra low temperature applications.

Constant operation: -55 °C +100 °C (-67 °F +212 °F)
air max T = +70 °C (+160 °F)

Safety factor: 1:4

Length: random

Item Code	↔			↔		↻		↻		↷		⚖	
	Dash	mm	in	mm	in	Mpa	psi	Mpa	psi	mm	in	kg/m	lb/ft
1003305	06	10,0	3/8"	21,70	0,85	50,0	7280	196,0	28000	120,0	4,72	0,771	0,52
1003292	08	13,0	1/2"	24,80	0,98	46,9	6800	188,0	27200	160,0	6,30	0,909	0,62
1003293	10	16,0	5/8"	28,30	1,11	41,0	6000	164,0	23500	210,0	8,27	1,146	0,78
1003230	12	19,0	3/4"	32,20	1,27	37,5	5500	150,0	22000	260,0	10,24	1,490	1,01
1003294	16	25,0	1"	40,40	1,59	32,7	4750	130,8	19000	310,0	12,20	2,100	1,42

// FLEXOR 4SP LT



EN 856 4SP

Tube: oil resistant ultra low temperature synthetic rubber.
Reinforcement: four high tensile steel spirals.
Cover: oil, water, ozone and ultra low temperature resistant synthetic rubber.
Application: very high pressure hydraulic lines, fuel oil, antifreeze solutions, air and water. Specially designed for ultra low temperature applications.
Constant operation: -55 °C +100 °C (-67 °F +212 °F)
 air max T = +70 °C (+160 °F)
Safety factor: 1:4
Length: random
Notes: specification reference: SAE 100 R15 (1/1, 3/8, 1/2)

Item Code	↔			↔		↻		↻		⤴		⚖	
	Dash	mm	in	mm	in	Mpa	psi	Mpa	psi	mm	in	kg/m	lb/ft
1003284	04	6,0	1/4"	17,90	0,70	45,0	6550	180,0	26200	150,0	5,91	0,580	0,39
1003285	06	10,0	3/8"	21,40	0,84	44,5	6450	178,0	25800	180,0	7,09	0,749	0,51
1003286	08	13,0	1/2"	24,60	0,97	42,0	6000	168,0	24000	230,0	9,06	0,880	0,60
1003231	10	16,0	5/8"	28,20	1,11	35,0	5000	140,0	20000	250,0	9,84	1,060	0,72
1003287	12	19,0	3/4"	32,20	1,27	38,0	5500	152,0	22040	300,0	11,81	1,440	0,97
1003288	16	25,0	1"	39,70	1,56	32,0	4640	128,0	18560	340,0	13,39	1,960	1,32

// FLEXOR 4SH LT



EN 856 4SH

Tube: oil resistant ultra low temperature synthetic rubber.
Reinforcement: four high tensile steel spirals.
Cover: oil, water, ozone and ultra low temperature resistant synthetic rubber.
Application: very high pressure hydraulic lines, fuel oil, antifreeze solutions, air and water. Specially designed for ultra low temperature applications.
Constant operation: -55 °C +100 °C (-67 °F +212 °F)
 air max T = +70 °C (+160 °F)
Safety factor: 1:4
Length: random up to 1" - 61 m max over 1"1/4

Item Code	↔			↔		↻		↻		⤴		⚖	
	Dash	mm	in	mm	in	Mpa	psi	Mpa	psi	mm	in	kg/m	lb/ft
1003232	16	25,0	1"	38,70	1,52	38,0	5500	152,0	22040	340,0	13,39	1,957	1,32
1003289	20	32,0	1 1/4"	45,50	1,79	35,0	5000	140,0	20000	460,0	18,11	2,470	1,66
1003290	24	38,0	1 1/2"	53,50	2,11	29,0	4200	116,0	16800	560,0	22,05	3,270	2,20
1003291	32	51,0	2"	68,10	2,68	25,0	3630	100,0	14500	700,0	27,56	4,670	3,14

Dimensions shown may be changed without prior notice

// OIL RETURN LINES

// FLEXOR R4 604



SAE 100 R4

Tube: oil resistant synthetic rubber.**Reinforcement:** high tensile textile cords with embedded steel helix wire.**Cover:** abrasion, ozone and hydrocarbon resistant synthetic rubber.**Application:** fuel, oil and hydraulic fluids with 50% max aromatic content suction and delivery. Specially designed for hydraulic oil return lines.**Constant operation:** -40 °C +100 °C (-40 °F +212 °F)**Safety factor:** 1:4**Length:** 61 m max

Item Code	↔			↔		↻		↻		↷		⚖	
	Dash	mm	in	mm	in	Mpa	psi	Mpa	psi	mm	in	kg/m	lb/ft
1001123	12	19,0	3/4"	30,00	1,18	2,1	300	8,4	1200	57,0	2,24	0,600	0,41
1001124	16	25,0	1"	36,00	1,42	1,7	250	6,8	986	75,0	2,95	0,740	0,50
1001126	20	32,0	1 1/4"	43,00	1,69	1,4	200	5,6	800	96,0	3,78	0,940	0,64
1001127	24	38,0	1 1/2"	49,00	1,93	1,0	150	4,0	600	114,0	4,49	1,080	0,73
1001128	32	51,0	2"	62,00	2,44	0,7	100	2,8	400	152,0	5,98	1,410	0,95
1001129	40	63,0	2 1/2"	76,00	2,99	0,4	60	1,6	240	189,0	7,44	2,040	1,38
1001672	48	76,0	3"	89,00	3,50	0,4	60	1,6	240	228,0	8,98	2,430	1,64
1001130	48	76,0	3"	89,00	3,50	0,4	60	1,6	240	228,0	8,98	2,430	1,64
1001131	56	90,0	3 1/2"	104,00	4,09	0,3	45	1,2	180	270,0	10,63	3,000	2,02
1001132	64	102,0	4"	116,00	4,57	0,2	30	0,8	120	306,0	12,05	3,350	2,26

// FLEXOR R4 634

EXTRA FLEXIBLE
SAE 100 R4**Tube:** oil resistant synthetic rubber.**Reinforcement:** high tensile textile cords with embedded steel helix wire.**Cover:** abrasion, ozone and hydrocarbon resistant synthetic rubber.**Application:** fuel, oil and hydraulic fluids with 50% max aromatic content suction and delivery. Specially designed for hydraulic oil return lines requiring tight bend radius.**Constant operation:** -40 °C +100 °C (-40 °F +212 °F)**Safety factor:** 1:4**Length:** 61 m max

Item Code	↔			↔		↻		↻		↷		⚖	
	Dash	mm	in	mm	in	Mpa	psi	Mpa	psi	mm	in	kg/m	lb/ft
1001272	12	19,0	3/4"	30,00	1,18	2,1	300	8,4	1200	38,0	1,50	0,600	0,41
1001273	16	25,0	1"	36,00	1,42	1,7	250	6,8	986	50,0	1,97	0,750	0,51
1001275	20	32,0	1 1/4"	43,00	1,69	1,4	200	5,6	800	64,0	2,52	0,920	0,62
1001278	24	38,0	1 1/2"	49,00	1,93	1,0	150	4,0	600	76,0	2,99	1,060	0,72
1001280	32	51,0	2"	62,00	2,44	0,7	100	2,8	400	102,0	4,02	1,380	0,93
1001282	40	63,0	2 1/2"	76,00	2,99	0,4	60	1,6	240	125,0	4,92	2,180	1,47
1001284	48	76,0	3"	89,00	3,50	0,4	60	1,6	240	152,0	5,98	2,590	1,75
1001288	64	102,0	4"	116,00	4,57	0,2	30	0,8	120	203,0	7,99	3,400	2,29

// FLEXOR R4 644 HT

**EXTRA FLEXIBLE - HIGH TEMP
SAE 100 R4**

Tube: oil resistant synthetic rubber.

Reinforcement: high tensile textile cords with embedded steel helix wire.

Cover: abrasion, ozone and hydrocarbon resistant synthetic rubber.

MSHA APPROVED

Application: fuel, oil and hydraulic fluids with 50% max aromatic content suction and delivery. Specially designed for high temperature applications and hydraulic oil return lines requiring tight bend radius.

Constant operation: -40 °C +135 °C (-40 °F +275 °F)

Safety factor: 1:4

Length: 61 m max

Item Code	↔			↔		↻		↻		↷		📦	
	Dash	mm	in	mm	in	Mpa	psi	Mpa	psi	mm	in	kg/m	lb/ft
1001277	12	19,0	3/4"	30,00	1,18	2,1	300	8,4	1200	38,0	1,50	0,630	0,43
1001274	16	25,0	1"	36,00	1,42	1,7	250	6,8	986	50,0	1,97	0,810	0,55
1001196	20	32,0	1 1/4"	43,00	1,69	1,4	200	5,6	800	64,0	2,52	1,000	0,68
1001279	24	38,0	1 1/2"	49,00	1,93	1,0	150	4,0	600	76,0	2,99	1,150	0,78
1001281	32	51,0	2"	62,00	2,44	0,7	100	2,8	400	102,0	4,02	1,490	1,01

Dimensions shown may be changed without prior notice

// PRESSURE WASH

// ALFAJET 210



Tube: oil, detergents and hot water resistant synthetic rubber.

Reinforcement: one high tensile steel braid.

Cover: smooth. Abrasion, ozone and hydrocarbon resistant blue synthetic rubber, pin-pricked. Black cover also available.

Application: high pressure power cleaners. Specially designed for hot water applications. Not recommended for steam service.

Safety factor: 1:4

Length: random

Item Code	↔			↔		↻		↻		⤴		⚖	
	Dash	mm	in	mm	in	Mpa	psi	Mpa	psi	mm	in	kg/m	lb/ft
1000192	04	6,0	1/4"	12,10	0,48	21,0	3000	84,0	12000	50,0	1,97	0,180	0,13
1000185	05	8,0	5/16"	14,10	0,56	21,0	3000	84,0	12000	60,0	2,36	0,190	0,13
1000098	06	10,0	3/8"	15,60	0,61	21,0	3000	84,0	12000	65,0	2,56	0,268	0,19
1000166	08	13,0	1/2"	19,50	0,77	21,0	3000	84,0	12000	90,0	3,54	0,390	0,27

// ALFAJET 400



Tube: oil, detergents and hot water resistant synthetic rubber.

Reinforcement: two high tensile steel braids.

Cover: smooth. abrasion, ozone and hydrocarbon resistant blue synthetic rubber, pin-pricked. Black cover also available.

Application: high pressure power cleaners. Specially designed for hot water applications. Not recommended for steam service.

Safety factor: 1:4

Length: random

Item Code	↔			↔		↻		↻		⤴		⚖	
	Dash	mm	in	mm	in	Mpa	psi	Mpa	psi	mm	in	kg/m	lb/ft
1000221	04	6,0	1/4"	13,20	0,52	40,0	5850	160,0	23200	70,0	2,76	0,253	0,18
1000220	05	8,0	5/16"	14,90	0,59	40,0	5850	140,0	20000	76,0	2,99	0,293	0,20
1000219	06	10,0	3/8"	16,70	0,66	40,0	5850	130,0	18900	90,0	3,54	0,380	0,26
1000218	08	13,0	1/2"	20,10	0,79	40,0	5850	120,0	17450	115,0	4,53	0,492	0,34

// PTFE HOSE

// 9TS 0M

**SMOOTH PTFE STAINLESS STEEL BRAID
STANDARD DUTY
EXCEEDS SAE 100 R14**

Tube: smooth ptfе - high mechanical and vibration resistance, low permeability, dielectrical, fire resistant, food grade (FDA, DVGW, BFR compliant). Chemically inert, non sticking, ozone and weather resistant.

Reinforcement: high tensile stainless steel braid AISI 304.

Application: compressed air, gas, steam, fuel, oil, chemical and pharmaceutical products, particularly suitable for steam piping on injection moulding machines, diathermic oil installations, charging lines for cryogenic gas, compressor discharge lines, automotive, pharmaceutical and food sectors. Solvents, pigments and paint transfer lines. Hydraulic lines in power steering marine applications. Not suitable for molten alkali metals and halogens at high temperature.

Constant operation: -60 °C +260 °C (-76 °F +500 °F)

Safety factor: 1:4

Item Code									
	mm	in	mm	mm	Mpa	psi	mm	in	
2600557	5,0	3/16"	7,86	0,89	27,6	4000	51,0	2,01	0,090
2600558	6,0	1/4"	8,64	0,64	24,1	3500	76,0	2,99	0,090
2600559	8,0	5/16"	11,05	0,64	20,7	3000	102,0	4,02	0,130
2600560	10,0	3/8"	12,65	0,64	18,3	2600	127,0	5,00	0,150
2600561	13,0	1/2"	15,40	0,76	16,1	2300	140,0	5,51	0,200
2600562	16,0	5/8"	18,40	0,89	13,8	2000	165,0	6,50	0,270
2600563	19,0	3/4"	22,10	0,89	11,4	1600	203,0	7,99	0,330
2600564	25,0	1"	29,75	1,10	6,9	1000	305,0	12,01	0,520

Dimensions shown may be changed without prior notice

// 9TC OM

**CONVOLUTED PTFE STAINLESS STEEL BRAID**

Tube: smooth ptfе - high mechanical and vibration resistance, low permeability, dielectrical, fire resistant, food grade (FDA, DVGW, BFR compliant). Chemically inert, non sticking, ozone and weather resistant.

Reinforcement: high tensile stainless steel braid AISI 304.

Application: compressed air, gas, steam, fuel, oil, chemical and pharmaceutical products, particularly suitable for steam piping on injection moulding machines, diathermic oil installations, charging lines for cryogenic gas, compressor discharge lines, automotive, pharmaceutical and food sectors. Solvents, pigments and paint transfer lines. Hydraulic lines in power steering marine applications. Not suitable for molten alkali metals and halogens at high temperature.

Constant operation: -60 °C +260 °C (-76 °F +500 °F)

Safety factor: 1:4

Item Code										
	mm	in	mm	mm	Mpa	psi	mm	in	kg/m	
2600574	13,0	1/2"	18,80	0,89	10,3	1500	25,0	0,98	0,280	
2600575	16,0	5/8"	22,10	0,89	8,3	1200	51,0	2,01	0,330	
2600576	19,0	3/4"	24,65	0,89	6,9	1000	64,0	2,52	0,400	
2600577	25,0	1"	32,77	1,02	4,6	670	89,0	3,50	0,550	
2600578	32,0	1 1/4"	40,72	1,02	3,4	525	127,0	5,00	0,690	
2600579	38,0	1 1/2"	48,25	1,12	3,0	450	152,0	5,98	0,890	
2600580	51,0	2"	61,50	1,20	2,3	345	200,0	7,87	1,240	



// FERRULE SELECTION CHART

// NO SKIVE.....	41	// INTERLOCK.....	43
// SKIVE.....	42	// ALFACRIMP.....	44

Dimensions shown may be changed without prior notice

// NO SKIVE FERRULE FOR STANDARD FITTINGS

Hose	Table n°	-03 DN 5 3/16"	-04 DN 6 1/4"	-05 DN 8 5/16"	-06 DN 10 3/8"	-08 DN 12 1/2"	-10 DN 16 5/8"	-12 DN 19 3/4"	-16 DN 25 1"	-20 DN 32 1 1/4"	-24 DN 38 1 1/2"	-32 DN 51 2"	-40 DN 63 2 1/2"	-48 DN 76 3"
ARGUS 1TE/R6 (HE)	209		H1100SK1	H1100SK1	H1100SK1	H1100SK1	H1100SK1	H1100SK1	H1100SK1					
ARGUS 2TE (HE)	210		H1100SK1	H1100SK1	H1100SK1	H1100SK1	H1100404	H1100404	H1100SK1					
ARGUS 2TE RAILWAY	210		H1100SK1	H1100SK1	H1100SK1	H1100SK1	H1100404	H1100404	H1100SK1					
ARGUS 3TE/R3 (HE)	252		H1200TX2	H1200TX2	H1200TX2	H1200TX2	H1200TX2	H1200TX2	H1200TX2	H1200TX2	H1200TX2	H1200TX2		
FLEXOR TWB1	200	H1200TP0	H1200TP0	H1200TP0	H1200TP0	H1200TP0	H1200TP0	H1200TP0	H1200TP0					
FLEXOR 7	198	H1200TP0	H1200TP0	H1200TP0	H1200TP0	H1200TP0								
FLEXOR 8	199	H1200TP0	H1200TP0	H1200TP0	H1200TP0	H1200TP0								
FLEXOPAK PLT	197	H1200TP0	H1100SK1	H1200TP0	H1200TP0	H1200TP0								
FLEXOPAK 1SC	178		H1200AD1	H1200AD1	H1200AD1	H1200AD1	H1200AD1	H1200AD1	H1200AD1					
	206	H1200TP0		H1200TP0	H1200TP0	H1200TP0								
AT3K MINETUFF	185		H1200AD1	H1200AD1	H1200AD1	H1200AD1	H1200AD1	H1200AD1	H1200AD1					
	248	H1200TP0		H1200TP0	H1200TP0	H1200TP0								
AT3K SUPERTUFF	185		H1200AD1	H1200AD1	H1200AD1	H1200AD1	H1200AD1	H1200AD1	H1200AD1					
	248	H1200TP0		H1200TP0	H1200TP0	H1200TP0								
ALFAJET 210	248	H1200TP0		H1200TP0	H1200TP0	H1200TP0								
	185		H1200AD1	H1200AD1	H1200AD1	H1200AD1	H1200AD1	H1200AD1	H1200AD1					
FLEXOPAK 2SC (HE)	176		H1200AD1	H1200AD1	H1200AD1	H1200AD1	H1200AD1	H1200AD1	H1200AD1					
FLEXOPAK 2SC MINETUFF	176		H1200AD1	H1200AD1	H1200AD1	H1200AD1	H1200AD1	H1200AD1	H1200AD1					
FLEXOPAK 2SC RAILWAY	176		H1200AD1	H1200AD1	H1200AD1	H1200AD1	H1200AD1	H1200AD1	H1200AD1					
ALFAJET 400	176		H1200AD1	H1200AD1	H1200AD1	H1200AD1	H1200AD1	H1200AD1	H1200AD1					
FLEXOPAK 2 MINETUFF	177		H1200AD1	H1200AD1	H1200AD1	H1200AD1	H1200AD1	H1200AD1	H1200AD1	H1200AD1	H1200AD1	H1200AD1	H1200TX2	
FLEXOPAK 2 SUPERTUFF	177		H1200AD1	H1200AD1	H1200AD1	H1200AD1	H1200AD1	H1200AD1	H1200AD1	H1200AD1				
FLEXOPAK 2 HT	177		H1200AD1	H1200AD1	H1200AD1	H1200AD1	H1200AD1	H1200AD1	H1200AD1	H1200AD1	H1200AD1	H1200AD1	H1200TX2	
FLEXOPAK 2 LT	177		H1200AD1	H1200AD1	H1200AD1	H1200AD1	H1200AD1	H1200AD1	H1200AD1	H1200AD1				
FLEXOR 1SN (HE)	173	H1200AD1	H1200AD1	H1200AD1	H1200AD1	H1200AD1	H1200AD1	H1200AD1	H1200AD1	H1200AD1	H1200AD1	H1200AD1		
FLEXOR 1SN MINETUFF	173	H1200AD1	H1200AD1	H1200AD1	H1200AD1	H1200AD1	H1200AD1	H1200AD1	H1200AD1	H1200AD1	H1200AD1	H1200AD1		
TEMP TECH 1SN	179		H1200AD1	H1200AD1	H1200AD1	H1200AD1	H1200AD1	H1200AD1	H1200AD1	H1200AD1	H1200AD1	H1200AD1		
FLEXOR 2SN (HE)	174	H1200AD2	H1200AD2	H1200AD2	H1200AD2	H1200AD2	H1200AD2	H1200AD2	H1200AD2	H1200AD2	H1200AD2	H1200AD2		
FLEXOR 2SN MINETUFF	174		H1200AD2	H1200AD2	H1200AD2	H1200AD2	H1200AD2	H1200AD2	H1200AD2	H1200AD2	H1200AD2	H1200AD2		
FLEXOR ELEVATOR	183							H1200AD1	H1200AD1	H1200AD1	H1200AD1			
FLEXOR 12	139				H1200204	H1200204	H1200204	H1200204	H1200204	H1200204	H1200204			
ALFABIOTECH 3000 MINETUFF	186									H1200204	H1200204			
ALFABIOTECH 4000 MINETUFF	194							H1200204	H1200204	H1200204				
ALFABIOTECH 5000 MINETUFF	258						H1200204							
ALFABIOTECH 6000 MINETUFF	259				H1200204	H1200204								
FLEXOR R4	018							H1200TX2	H1200TX2	H1200TX2	H1200TX2	H1200TX2	H1200TX2	
PTFE - 9TS	201	H2200TF0	H2200TF0	H2200TF0	H2200TF0	H2200TF0	H2200TF0	H2200TF0	H2200TF0					
PTFE - 9TC	203				H2200TF0	H2200TF0	H2200TF0	H2200TF0	H2200TF0	H2200TF0	H2200TF0	H2200TF0		

Hose	Crimping Table n°	-04 DN 5 3/16"	-05 DN 6 1/4"	-06 DN 8 5/16"	-08 DN 11 13/32"	-10 DN 12 1/2"	-12 DN 16 5/8"	-16 DN 22 7/8"	-20 DN 29 1 1/8"	-24 DN 35 1 3/8"	-32 DN 48 1 13/16"
FLEXOR 5	261	H1200TX2-03	H1200TX2-04	H1200TX2-05	H1200TX2-06*	H1200TX2-08	H1200TX2-10	H1200TX2-12*	H1200TX2-16*	H1200TX2-20*	H1200TX2-32*
TEMP TECH R5	261	H1200TX2-03	H1200TX2-04	H1200TX2-05	H1200TX2-06*	H1200TX2-08	H1200TX2-10	H1200TX2-12*	H1200TX2-16*	H1200TX2-20*	H1200TX2-32*

* for these dimensions is necessary to use the specific insert for R5 hose

// SKIVE FERRULE FOR STANDARD FITTINGS

Rose	Table n°	-03 DN 5 3/16"	-04 DN 6 1/4"	-05 DN 8 5/16"	-06 DN 10 3/8"	-08 DN 12 1/2"	-10 DN 16 5/8"	-12 DN 19 3/4"	-16 DN 25 1"	-20 DN 32 1 1/4"	-24 DN 38 1 1/2"	-32 DN 51 2"	-40 DN 63 2 1/2"	-48 DN 76 3"
FLEXOPAK 1SC	208		H1100SK1	H1100SK1	H1100SK1	H1100SK1	H1100SK1	H1100SK1	H1100SK1					
AT3K MINETUFF	239		H1100SK1	H1100SK1	H1100SK1	H1100SK1	H1100SK1	H1100SK1	H1100SK1					
AT3K SUPERTUFF	239		H1100SK1	H1100SK1	H1100SK1	H1100SK1	H1100SK1	H1100SK1	H1100SK1					
ALFAJET 210	239		H1100SK1	H1100SK1	H1100SK1	H1100SK1	H1100SK1	H1100SK1	H1100SK1					
FLEXOR 1SN MINETUFF	223		H1100SK1	H1100SK1	H1100SK1	H1100SK1	H1100SK1	H1100SK1	H1100SK1					
TEMP TECH 1SN	240		H1100SK1	H1100SK1	H1100SK1	H1100SK1	H1100SK1	H1100SK1	H1100SK1					
FLEXOPAK 2SC (HF)	222		H1100SK1	H1100SK1	H1100SK1	H1100SK1	H1100SK1	H1100SK1	H1100SK1					
FLEXOPAK 2SC MINETUFF	222		H1100SK1	H1100SK1	H1100SK1	H1100SK1	H1100SK1	H1100SK1	H1100SK1					
ALFAJET 400	222		H1100SK1	H1100SK1	H1100SK1	H1100SK1	H1100SK1	H1100SK1	H1100SK1					
FLEXOPAK 2 MINETUFF	207		H1100SK1	H1100SK1	H1100SK1	H1100SK1	H1100SK1	H1100SK1	H1100SK1	H1100404	H1100104	H1100404		
FLEXOPAK 2 SUPERTUFF	207		H1100SK1	H1100SK1	H1100SK1	H1100SK1	H1100SK1	H1100SK1	H1100SK1					
FLEXOPAK 2 HT	207		H1100SK1	H1100SK1	H1100SK1	H1100SK1	H1100SK1	H1100SK1	H1100SK1	H1100404	H1100104	H1100404		
FLEXOPAK 2 LT	207		H1100SK1	H1100SK1	H1100SK1	H1100SK1	H1100SK1	H1100SK1	H1100SK1	H1100404				
FLEXOR 2SN (HF)	235		H1100404	H1100404	H1100404	H1100404	H1100404	H1100404	H1100404	H1100404	H1100404	H1100404		
FLEXOR 2SN MINETUFF	235		H1100404	H1100404	H1100404	H1100404	H1100404	H1100404	H1100404	H1100404	H1100404	H1100404		
TEMP TECH 2SN	237		H1100404	H1100404	H1100404	H1100404	H1100404	H1100404	H1100404	H1100404	H1100404	H1100404		
FLEXOR ELEVATOR	184												H1100104	
FLEXOR 12	62				H1100404	H1100404	H1100404	H1100404	H1100404	H1100404	H1100404	H1100404		
FLEXOR R15 MINETUFF	145		H1100404		H1100404	H1100404								
FLEXOR 4SP	41		H1100404		H1100404	H1100404	H1100404	H1100404	H1100404					
FLEXOR 4SP LT	41		H1100404		H1100404	H1100404	H1100404	H1100404	H1100404					
ALFAFOREST	33				H1100404	H1100404	H1100404	H1100404	H1100404	H1100404				
ALFAFOREST LT	33				H1100404	H1100404	H1100404	H1100404	H1100404	H1100404				
ALFABIOTECH 2000 MINETUFF	212													H1100404 H1100404
ALFABIOTECH 3000 MINETUFF	229									H1100404	H1100404			
ALFABIOTECH 4000 MINETUFF	187					H1100404		H1100404	H1100404					
ALFABIOTECH 5000 MINETUFF	188						H1100404	H1100404	H1100404					
ALFABIOTECH 5000 SUPERTUFF	188						H1100404	H1100404	H1100404					
ALFABIOTECH 5000 PLUS MINETUFF	211							H1100404						
ALFABIOTECH 6000 MINETUFF	192		H1100404		H1100404	H1100404								
ALFABIOTECH 6000 SUPERTUFF	192		H1100404		H1100404	H1100404								

Dimensions shown may be changed without prior notice

// INTERLOCK FERRULE FOR INTERLOCK FITTINGS

Hose	Table n°	-06 DN 10 3/8"	-08 DN 12 1/2"	-10 DN 16 5/8"	-12 DN 19 3/4"	-16 DN 25 1"	-20 DN 32 1 1/4"	-24 DN 38 1 1/2"	-32 DN 51 2"	-40 DN 63 2 1/2"	-48 DN 76 3"
FLEXOR 13	7				H1400200	H1400200	H1400301	H1400301	H1400301	H1T00600	
FLEXOR 15 MINETUFF	146			H1400301	H1400200	H1400200	H1400301	H1400301	H1T00600		
FLEXOR 4SH	8				H1400200	H1400200	H1400200	H1400200	H1400200		
FLEXOR 4SH LT	8				H1400200	H1400200	H1400200	H1400200	H1400200		
ALFABIOTECH 3000 MINETUFF	217										H1T00600
ALFABIOTECH 4000 MINETUFF	195					H1400200		H1400200	H1400200		
ALFABIOTECH 5000 MINETUFF	189				H1400200	H1400200	H1400200	H1400301	H1400301		
ALFABIOTECH 5000 PLUS MINETUFF	190				H1400200	H1400200					
ALFABIOTECH 6000 MINETUFF - 4S	191			H1400301	H1400200	H1400200	H1400301				
ALFABIOTECH 6000 MINETUFF - 6S							H1400301	H1400301			
AT7K MINETUFF	101			H1400301			H1400301	H1400301			
AT8K MINETUFF - 4S	102				H1400301	H1T00600*					
AT8K MINETUFF - 6S					H1400301						

* suitable with only ALFAGOMMA H1T special inserts

// NO SKIVE FERRULE FOR MULTISPIRAL FITTINGS

Hose	Table n°	-06 DN 10 3/8"	-08 DN 12 1/2"	-10 DN 16 5/8"	-12 DN 19 3/4"	-16 DN 25 1"	-20 DN 32 1 1/4"	-24 DN 38 1 1/2"	-32 DN 51 2"	-40 DN 63 2 1/2"	-48 DN 76 3"
FLEXOR R13	273					H1300NS4					
FLEXOR 4SH MT	274				H1300NS4	H1300NS4	H1300NS4	H1300NS4	H1300NS4		
ALFABIOTECH 4000 MINETUFF	275							H1300NS4	H1300NS4		
ALFABIOTECH 5000 MINETUFF - 4S	276				H1300NS4	H1300NS4	H1300NS4				
ALFABIOTECH 5000 MINETUFF - 6S	280							H1300NS6	H1300NS6		
ALFABIOTECH 5000 PLUS MINETUFF	277				H1300NS4	H1300NS4					
ALFABIOTECH 6000 MINETUFF - 4S	278				H1300NS4	H1300NS4					
ALFABIOTECH 6000 MINETUFF - 6S	282						H1300NS6				

// SKIVE FERRULE FOR MULTISPIRAL FITTINGS

Hose	Table n°	-06 DN 10 3/8"	-08 DN 12 1/2"	-10 DN 16 5/8"	-12 DN 19 3/4"	-16 DN 25 1"	-20 DN 32 1 1/4"	-24 DN 38 1 1/2"	-32 DN 51 2"	-40 DN 63 2 1/2"	-48 DN 76 3"
ALFABIOTECH 4000 MINETUFF	264							H1300SK4	H1300SK4		
ALFABIOTECH 5000 MINETUFF	265				H1300SK4	H1300SK4	H1300SK4				
ALFABIOTECH 5000 PLUS MINETUFF	266				H1300SK4	H1300SK4					
ALFABIOTECH 6000 MINETUFF	267				H1300SK4	H1300SK4					

// ALFACRIMP - ONE PIECE NO SKIVE

Hose	Table n°	-04 DN 6 1/4"	-05 DN 8 5/16"	-06 DN 10 3/8"	-08 DN 12 1/2"	-10 DN 16 5/8"	-12 DN 19 3/4"	-16 DN 25 1"	-20 DN 32 1 1/4"	-24 DN 38 1 1/2"	-32 DN 51 2"	-48 DN 76 3"
FLEXOPAK 1SC	218	C12A	C12A	C12A	C12A	C12A	C12A	C12A				
AT3K MINETUFF	249	C12A	C12A	C12A	C12A							
ALFAJET 210	249	C12A	C12A	C12A	C12A							
FLEXOPAK 2SC (HP)	220	C12A	C12A	C12A	C12A	C12A	C12A	C12A				
FLEXOPAK 2SC MINETUFF	220	C12A	C12A	C12A	C12A	C12A	C12A	C12A				
ALFAJET 400	220	C12A	C12A	C12A	C12A	C12A	C12A	C12A				
FLEXOPAK 2 MINETUFF	219	C12A	C12A	C12A	C12A	C12A	C12A	C12A				
	228							C124	C124	C124	C124	C122
FLEXOPAK 2 HT	219	C12A	C12A	C12A	C12A	C12A	C12A	C12A				
	228							C124	C124	C124	C124	C122
FLEXOPAK 2 LT	219	C12A	C12A	C12A	C12A	C12A	C12A	C12A				
	228							C124	C124			
FLEXOR 1SN (HP)	215	C12A	C12A	C12A	C12A	C12A	C12A	C12A	C124	C124	C124	
FLEXOR 1SN MINETUFF	215	C12A	C12A	C12A	C12A	C12A	C12A	C12A	C124	C124	C124	
TEMP TECH 1SN	250	C12A	C12A	C12A	C12A	C12A	C12A	C12A				
	92					C124	C124	C124	C124	C124	C124	
FLEXOR 2SN (HP)	216	C12A	C12A	C12A	C12A	C12A	C12A	C12A				
	227				C124	C124	C124	C124	C124	C124	C124	
FLEXOR 2SN MINETUFF	216	C12A	C12A	C12A	C12A	C12A	C12A	C12A				
	227				C124	C124	C124	C124	C124	C124	C124	
TEMP TECH 2SN	236	C12A	C12A	C12A		C12A	C12A	C12A				
	93			C124	C124	C124	C124	C124	C124	C124	C124	
FLEXOR 12	94			C124	C124	C124	C124	C124	C124	C124	C124	
	196						C126	C126	C126	C126		
FLEXOR 13	127						C126	C126	C126	C126	C12R	
FLEXOR 4SH	128						C126	C126	C126	C126	C12H	
ALFABIOTECH 3000 MINETUFF	213								C124	C124	C124	
ALFABIOTECH 4000 MINETUFF	241				C124		C124	C124	C124*			
ALFABIOTECH 5000 MINETUFF	244					C124#	C124*					
	246						C126	C126	C126	C126	C12R	
ALFABIOTECH 6000 MINETUFF	245			C124#	C124#	C124*						
	214						C126	C126	C126			

validated for use at only 280 bar (4000 PSI) WP

* under validation

ALFAGOMMA

**ALFAGOMMA TOP COAT
OVER 10 TIMES HIGHER
THAN STANDARD**



TOP COAT

- ▲ **TESTED IN ACCORDANCE WITH ASTM B117-03 AND UNI ISO 9927 STANDARDS**
- ▲ **OVER 500 HOURS CORROSION PREVENTION IN SALT SPRAY FOG TO WHITE RUST**
- ▲ **MORE THAN 1000 HOURS CORROSION RESISTANCE TO RED RUST**

Resistance to red rust in salt fog (test in compliance with ISO 9227)

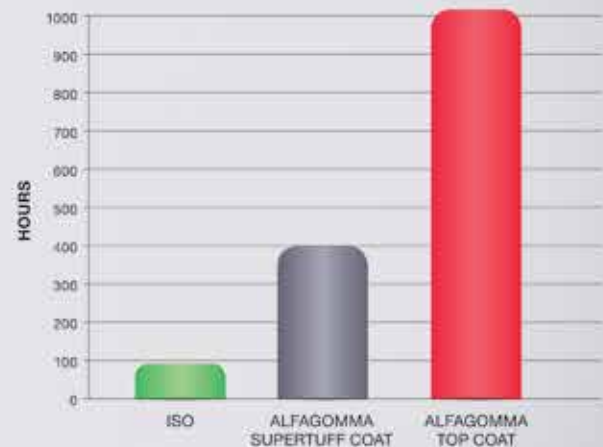



// STANDARD

// FERRULES	47
// HOSE MENDER	49
// BSP INSERTS	50
// DIN METRIC INSERTS	57
// PRESSURE WASHER	71
// SAE INSERTS	72
// JIC 37° INSERTS	75

// NPTF INSERTS	81
// NPSM INSERTS	83
// ORFS INSERTS	84
// FRENCH INSERTS	88
// JIS INSERTS	89
// KOMATSU INSERTS	91
// SAE FLANGES	93

Dimensions shown may be changed without prior notice

// FERRULES

// H1100104 Skive Ferrule

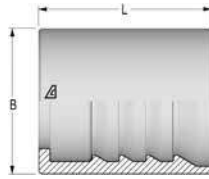

Item Code	ID			B	L
	Dash	mm	in		
1201545	20	31,0	1 1/4"	50,0	43,8
1201546	24	38,0	1 1/2"	57,0	49,2
1201547	32	51,0	2"	71,0	63,7

// H1100404 Skive Ferrule

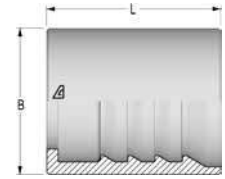

Item Code	ID			B	L
	Dash	mm	in		
1202719	04	6,0	1/4"	22,0	26,3
1203253	06	10,0	3/8"	25,0	28,5
1203266	08	13,0	1/2"	29,0	34,7
1219132	10	16,0	5/8"	33,0	37,5
1203368	12	19,0	3/4"	37,0	41,5
1234701	16	25,0	1"	45,0	47,7
1234766	20	31,0	1 1/4"	55,0	54,5
1234767	24	38,0	1 1/2"	67,0	61,1
1234768	32	51,0	2"	82,0	75,1

// H1200204 No-skive Ferrule

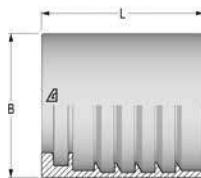

Item Code	ID			B	L
	Dash	mm	in		
1216588	06	10,0	3/8"	30,0	28,0
1216589	08	13,0	1/2"	34,0	33,9
1216590	10	16,0	5/8"	38,0	36,6
1203322	12	19,0	3/4"	42,0	39,5
1203323	16	25,0	1"	50,0	47,5
1216591	20	31,0	1 1/4"	61,0	50,2

// H1200203 No-skive Ferrule

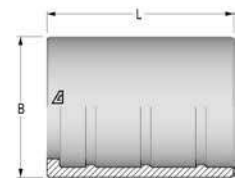

Item Code	ID			B	L
	Dash	mm	in		
1203311	03	5,0	3/16"	20,0	24,3
1202720	04	6,0	1/4"	22,0	26,3
1202721	05	8,0	5/16"	25,0	26,3
1202722	06	10,0	3/8"	25,0	27,2
1202723	08	13,0	1/2"	29,0	32,8
1202724	10	16,0	5/8"	34,0	35,6
1202725	12	19,0	3/4"	38,0	38,6
1202726	16	25,0	1"	50,0	45,4
1202727	20	31,0	1 1/4"	51,0	49,0
1202728	24	38,0	1 1/2"	60,0	56,0
1202729	32	51,0	2"	76,1	69,0
1203062	40	63,0	2 1/2"	88,9	85,0

// H1100SK1 Skive Ferrule

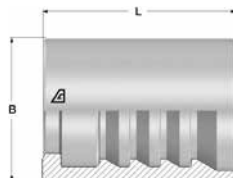

Item Code	ID			B	L
	Dash	mm	in		
1233077	04	6,0	1/4"	19,0	25,5
1233078	05	8,0	5/16"	21,0	25,5
1233079	06	10,0	3/8"	23,0	27,5
1233080	08	13,0	1/2"	27,0	33,5
1233081	10	16,0	5/8"	30,0	36,5
1233082	12	19,0	3/4"	33,0	40,0
1233083	16	25,0	1"	41,0	46,5

// H1200TP0 No-skive Ferrule

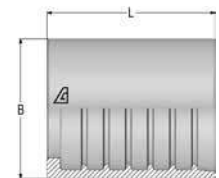

Item Code	ID			B	L
	Dash	mm	in		
1232354	03	5,0	3/16"	15,0	22,0
1232358	04	6,0	1/4"	17,0	26,5
1232359	05	8,0	5/16"	19,0	26,5
1232360	06	10,0	3/8"	22,0	26,5
1232361	08	13,0	1/2"	26,0	30,5

// H2200TF0
No-skive Ferrule

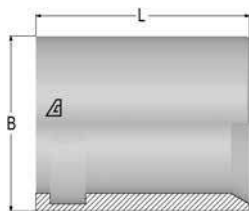

Item Code	ID		B	L	
	Dash	mm			in
1232132	03	5,0	3/16"	14,0	20,0
1232133	04	6,0	1/4"	15,0	25,0
1232134	05	8,0	5/16"	17,2	25,0
1232135	06	10,0	3/8"	22,0	25,0
1232136	08	13,0	1/2"	25,0	30,0
1232137	10	16,0	5/8"	30,0	33,0
1232138	12	19,0	3/4"	35,0	37,0
1232139	16	25,0	1"	42,0	45,0
1232140	20	31,0	1 1/4"	50,0	48,0
1232141	24	38,0	1 1/2"	57,0	58,0
1232142	32	51,0	2"	73,0	67,0

// H1200TX2
No-skive Ferrule

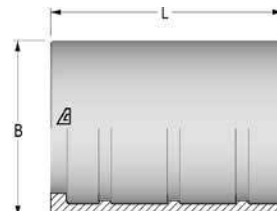

Item Code	ID		B	L	
	Dash	mm			in
1236581	03	5,0	3/16"	21,0	21,5
1236582	04	6,0	1/4"	23,0	24,7
1236583	05	8,0	5/16"	25,0	24,7
1236584	06	10,0	3/8"	27,0	29,7
1236585	08	13,0	1/2"	30,0	30,5
1236586	10	16,0	5/8"	34,0	35,5
1236587	12	19,0	3/4"	38,0	36,0
1236588	16	25,0	1"	48,0	42,5
1236589	20	31,0	1 1/4"	53,0	56,5
1236590	24	38,0	1 1/2"	60,0	61,5
1236591	32	51,0	2"	76,0	73,5
1236592	40	63,0	2 1/2"	89,0	85,0

// H1200AD1
No-skive Ferrule

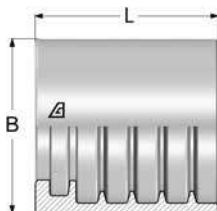

Item Code	ID		B	L	
	Dash	mm			in
1227977	03	5,0	3/16"	19,0	24,0
1227978	04	6,0	1/4"	22,0	24,7
1227979	05	8,0	5/16"	23,0	24,7
1227980	06	10,0	3/8"	26,0	29,7
1227981	08	13,0	1/2"	29,0	30,5
1227983	10	16,0	5/8"	32,0	30,5
1227985	12	19,0	3/4"	36,0	36,0
1227986	16	25,0	1"	44,0	36,7
1227987	20	31,0	1 1/4"	53,0	48,6
1227988	24	38,0	1 1/2"	61,0	48,6
1227989	32	51,0	2"	75,0	48,6

// H1200AD2
No-skive Ferrule

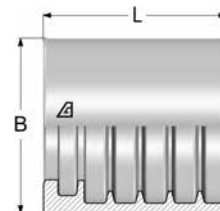

Item Code	ID		B	L	
	Dash	mm			in
1227990	03	5,0	3/16"	21,0	21,5
1227991	04	6,0	1/4"	23,0	24,7
1227992	05	8,0	5/16"	25,0	24,7
1227993	06	10,0	3/8"	27,0	29,7
1227994	08	13,0	1/2"	30,0	30,5
1227995	10	16,0	5/8"	33,0	30,5
1243517	12	19,0	3/4"	37,0	42,0
1227996	12	19,0	3/4"	37,0	36,0
1227997	16	25,0	1"	45,0	36,7
1227998	20	31,0	1 1/4"	56,0	48,6
1227999	24	38,0	1 1/2"	64,0	48,5
1228000	32	51,0	2"	78,0	48,6

Dimensions shown may be changed without prior notice

// HOSE MENDER

// H12C5610

Hose Mender

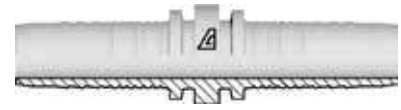

Item Code	Tail/Head	ID			F1
	Dash	Dash	mm	in	Dash Size
1202949	-0404	04	6,0	1/4"	04
1202870	-0505	05	8,0	5/16"	05
1202868	-0606	06	10,0	3/8"	06
1202867	-0808	08	13,0	1/2"	08
1203160	-1010	10	16,0	5/8"	10
1203161	-1212	12	19,0	3/4"	12
1220608	-1616	16	25,0	1"	16
1220607	-2020	20	32,0	1 1/4"	20
1220605	-2424	24	38,0	1 1/2"	24
1220606	-3232	32	51,0	2"	32

// BSP INSERTS

// H1210510

**BSP Male 60° Flare
AGR**

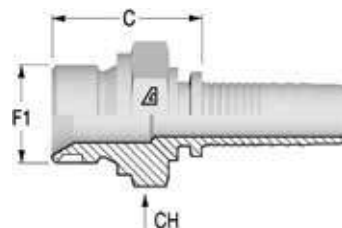

Item Code	Tail/Head	Nut Type	ID			F1	F1	C	CH
	Dash		Dash	mm	in	Dash Size		mm	mm
1201291	-0302	NA	03	5,0	3/16"	02	1/8-28	20,3	14,0
1201722	-0402	NA	04	6,0	1/4"	02	1/8-28	20,8	14,0
1200507	-0404	NA	04	6,0	1/4"	04	1/4-19	26,3	19,0
1200508	-0406	NA	04	6,0	1/4"	06	3/8-19	27,8	22,0
1201098	-0408	NA	04	6,0	1/4"	08	1/2-14	31,3	27,0
1200540	-0504	NA	05	8,0	5/16"	04	1/4-19	26,3	19,0
1200541	-0506	NA	05	8,0	5/16"	06	3/8-19	27,8	22,0
1201101	-0508	NA	05	8,0	5/16"	08	1/2-14	31,3	27,0
1200340	-0604	NA	06	10,0	3/8"	04	1/4-19	26,3	19,0
1200341	-0606	NA	06	10,0	3/8"	06	3/8-19	27,8	22,0
1200339	-0608	NA	06	10,0	3/8"	08	1/2-14	31,3	27,0
1200386	-0806	NA	08	13,0	1/2"	06	3/8-19	28,6	22,0
1200384	-0808	NA	08	13,0	1/2"	08	1/2-14	32,1	27,0
1201096	-0810	NA	08	13,0	1/2"	10	5/8-14	34,1	30,0
1200385	-0812	NA	08	13,0	1/2"	12	3/4-14	36,1	32,0
1201085	-1008	NA	10	16,0	5/8"	08	1/2-14	32,1	27,0
1200419	-1010	NA	10	16,0	5/8"	10	5/8-14	34,1	30,0
1200418	-1012	NA	10	16,0	5/8"	12	3/4-14	36,1	32,0
1200446	-1212	NA	12	19,0	3/4"	12	3/4-14	36,6	32,0
1201095	-1216	NA	12	19,0	3/4"	16	1-11	41,6	41,0
1201355	-1616	NA	16	25,0	1"	16	1-11	42,4	41,0
1201356	-1620	NA	16	25,0	1"	20	1 1/4-11	46,4	50,0
1201357	-2020	NA	20	32,0	1 1/4"	20	1 1/4-11	48,0	50,0
1201358	-2424	NA	24	38,0	1 1/2"	24	1 1/2-11	51,0	55,0
1221561	-2432	NA	24	38,0	1 1/2"	32	2-11	56,5	70,0
1201359	-3232	NA	32	51,0	2"	32	2-11	56,5	70,0

// H1210610

**BSP Male Flat Seat
AGR FD**

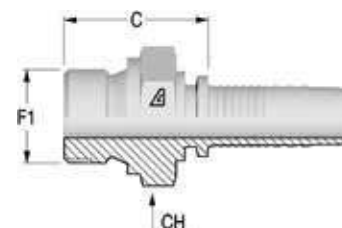

Item Code	Tail/Head	Nut Type	ID			F1	F1	C	CH
	Dash		Dash	mm	in	Dash Size		mm	mm
1214181	-0404	NA	04	6,0	1/4"	04	1/4-19	26,3	19,0
1223423	-0606	NA	06	10,0	3/8"	06	3/8-19	27,8	22,0
1216596	-0608	NA	06	10,0	3/8"	08	1/2-14	31,3	27,0
1225012	-0808	NA	08	13,0	1/2"	08	1/2-14	32,1	27,0
1216597	-1010	NA	10	16,0	5/8"	10	5/8-14	34,1	30,0

Dimensions shown may be changed without prior notice

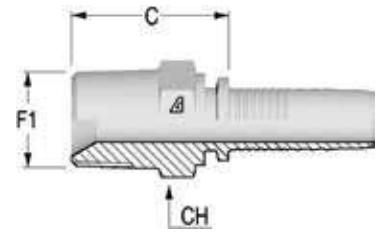
// H1210710
**BSPT Male
AGR K**

Item Code	Tail/Head	Nut Type	ID			F1	F1	C	CH
	Dash		Dash	mm	in	Dash Size		mm	mm
1200456	-0302	NA	03	5,0	3/16"	02	1/8-28	20,8	12,0
1200491	-0402	NA	04	6,0	1/4"	02	1/8-28	21,3	12,0
1200490	-0404	NA	04	6,0	1/4"	04	1/4-19	26,8	17,0
1200492	-0406	NA	04	6,0	1/4"	06	3/8-19	27,8	19,0
1200532	-0504	NA	05	8,0	5/16"	04	1/4-19	26,8	17,0
1200533	-0506	NA	05	8,0	5/16"	06	3/8-19	27,8	19,0
1200328	-0604	NA	06	10,0	3/8"	04	1/4-19	26,8	17,0
1200329	-0606	NA	06	10,0	3/8"	06	3/8-19	27,8	19,0
1200327	-0608	NA	06	10,0	3/8"	08	1/2-14	32,3	22,0
1200373	-0806	NA	08	13,0	1/2"	06	3/8-19	28,6	19,0
1200371	-0808	NA	08	13,0	1/2"	08	1/2-14	33,1	22,0
1200410	-1012	NA	10	16,0	5/8"	12	3/4-14	34,1	27,0
1200440	-1212	NA	12	19,0	3/4"	12	3/4-14	34,6	27,0
1200439	-1216	NA	12	19,0	3/4"	16	1-11	43,6	36,0
1201365	-1612	NA	16	25,0	1"	12	3/4-14	37,4	32,0
1201361	-1616	NA	16	25,0	1"	16	1-11	44,4	36,0
1201363	-2020	NA	20	32,0	1 1/4"	20	1 1/4-11	49,0	46,0
1201364	-2424	NA	24	38,0	1 1/2"	24	1 1/2-11	50,5	50,0
1201360	-3232	NA	32	51,0	2"	32	2-11	54,2	65,0

// H1220813

**BSPF Female 60° Cone with O-Ring
DKOR**

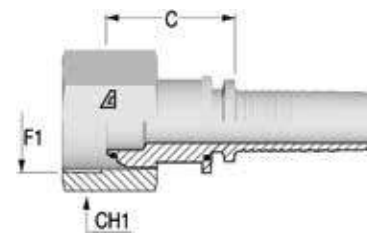

Item Code	Tail/Head	Nut Type	ID			F1	F1	C	CH1
	Dash		Dash	mm	in	Dash Size			
1200606	-0302	CR	03	5,0	3/16"	02	1/8-28	14,3	14,0
1202325	-0304	SN	03	5,0	3/16"	04	1/4-19	20,3	19,0
1201066	-0402	CR	04	6,0	1/4"	02	1/8-28	14,7	14,0
1202326	-0404	SN	04	6,0	1/4"	04	1/4-19	20,8	19,0
1202327	-0406	SN	04	6,0	1/4"	06	3/8-19	23,3	22,0
1202328	-0504	CR	05	8,0	5/16"	04	1/4-19	17,3	19,0
1202329	-0506	SN	05	8,0	5/16"	06	3/8-19	23,3	22,0
1202330	-0604	CR	06	10,0	3/8"	04	1/4-19	17,3	19,0
1202331	-0606	SN	06	10,0	3/8"	06	3/8-19	23,3	22,0
1202332	-0608	SN	06	10,0	3/8"	08	1/2-14	24,3	27,0
1202571	-0806	CR	08	13,0	1/2"	06	3/8-19	18,6	22,0
1202333	-0808	SN	08	13,0	1/2"	08	1/2-14	25,1	27,0
1202334	-0810	SN	08	13,0	1/2"	10	5/8-14	28,4	27,0
1202335	-0812	SN	08	13,0	1/2"	12	3/4-14	29,0	32,0
1202457	-1010	CR	10	16,0	5/8"	10	5/8-14	17,1	27,0
1202336	-1012	SN	10	16,0	5/8"	12	3/4-14	29,0	32,0
1202462	-1212	CR	12	19,0	3/4"	12	3/4-14	23,9	32,0
1202337	-1216	SN	12	19,0	3/4"	16	1-11	34,0	38,0
1202455	-1616	CR	16	25,0	1"	16	1-11	23,9	38,0
1202338	-1620	SN	16	25,0	1"	20	1 1/4-11	39,4	50,0
1202458	-2020	TN	20	32,0	1 1/4"	20	1 1/4-11	32,0	50,0
1202339	-2024	SN	20	32,0	1 1/4"	24	1 1/2-11	41,9	55,0
1202463	-2424	TN	24	38,0	1 1/2"	24	1 1/2-11	33,8	55,0
1202340	-2432	SN	24	38,0	1 1/2"	32	2-11	47,0	70,0
1202014	-3232	TN	32	51,0	2"	32	2-11	34,0	70,0

Dimensions shown may be changed without prior notice

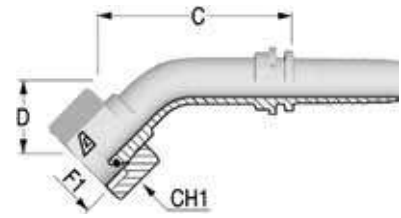
// H1220843
**45° BSPP Female 60° Cone with O-Ring
DKOR 45
Solid one piece**

Item Code	Tail/Head	Nut Type	ID			F1	F1	C	D Drop	CH1
	Dash		Dash	mm	in	Dash Size				
1202341	-0404	SN	04	6,0	1/4"	04	1/4-19	45,5	15,0	19,0
1202342	-0406	SN	04	6,0	1/4"	06	3/8-19	41,5	17,5	22,0
1214200	-0504	CR	05	8,0	5/16"	04	1/4-19	19,0	17,5	19,0
1202343	-0506	SN	05	8,0	5/16"	06	3/8-19	45,1	18,5	22,0
1202344	-0606	SN	06	10,0	3/8"	06	3/8-19	49,9	20,5	22,0
1202345	-0608	SN	06	10,0	3/8"	08	1/2-14	45,7	21,0	27,0
1202346	-0808	SN	08	13,0	1/2"	08	1/2-14	55,0	21,0	27,0
1202347	-0810	SN	08	13,0	1/2"	10	5/8-14	57,2	23,0	27,0
1202348	-0812	SN	08	13,0	1/2"	12	3/4-14	56,7	23,0	32,0
1202464	-1010	CR	10	16,0	5/8"	10	5/8-14	64,0	21,5	27,0
1202349	-1012	SN	10	16,0	5/8"	12	3/4-14	66,5	22,5	32,0
1202465	-1212	CR	12	19,0	3/4"	12	3/4-14	70,0	28,0	32,0
1202350	-1216	SN	12	19,0	3/4"	16	1-11	74,6	31,5	38,0
1202466	-1616	CR	16	25,0	1"	16	1-11	84,0	34,0	38,0
1216663	-1620	SN	16	25,0	1"	20	1 1/4-11	97,0	47,5	50,0
1202467	-2020	TN	20	32,0	1 1/4"	20	1 1/4-11	100,8	40,0	50,0
1202351	-2024	SN	20	32,0	1 1/4"	24	1 1/2-11	114,9	38,0	55,0
1202468	-2424	TN	24	38,0	1 1/2"	24	1 1/2-11	115,7	46,0	55,0
1202352	-2432	SN	24	38,0	1 1/2"	32	2-11	122,4	45,0	70,0
1202469	-3232	TN	32	51,0	2"	32	2-11	151,5	60,0	70,0

// H1220893

**90° BSPP Female 60° Cone with O-Ring
DKOR 90
Solid one piece**

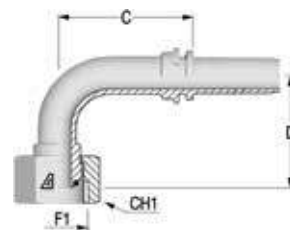

Item Code	Tail/Head	Nut Type	ID			F1	F1	C	D Drop	CH1
	Dash		Dash	mm	in	Dash Size				
1200607	-0302	CR	03	5,0	3/16"	02	1/8-28	24,0	30,0	14,0
1202474	-0304	SN	03	5,0	3/16"	04	1/4-19	32,6	30,0	19,0
1201707	-0402	CR	04	6,0	1/4"	02	1/8-28	30,5	32,0	14,0
1202367	-0404	SN	04	6,0	1/4"	04	1/4-19	29,3	29,0	19,0
1202353	-0406	SN	04	6,0	1/4"	06	3/8-19	29,8	31,0	22,0
1202354	-0506	SN	05	8,0	5/16"	06	3/8-19	33,2	36,0	22,0
1202355	-0606	SN	06	10,0	3/8"	06	3/8-19	34,8	42,0	22,0
1202356	-0608	SN	06	10,0	3/8"	08	1/2-14	34,3	35,5	27,0
1202881	-0806	CR	08	13,0	1/2"	06	3/8-19	35,3	43,0	22,0
1202357	-0808	SN	08	13,0	1/2"	08	1/2-14	35,8	41,0	27,0
1202358	-0810	SN	08	13,0	1/2"	10	5/8-14	41,6	43,5	27,0
1202359	-0812	SN	08	13,0	1/2"	12	3/4-14	41,8	43,0	32,0
1202470	-1010	CR	10	16,0	5/8"	10	5/8-14	47,9	47,0	27,0
1202360	-1012	SN	10	16,0	5/8"	12	3/4-14	51,9	49,0	32,0
1202471	-1212	CR	12	19,0	3/4"	12	3/4-14	49,1	53,0	32,0
1202361	-1216	SN	12	19,0	3/4"	16	1-11	54,1	60,5	38,0
1202475	-1616	CR	16	25,0	1"	16	1-11	75,1	69,0	38,0
1202362	-1620	SN	16	25,0	1"	20	1 1/4-11	75,1	88,5	50,0
1202472	-2020	TN	20	32,0	1 1/4"	20	1 1/4-11	82,3	83,0	50,0
1202363	-2024	SN	20	32,0	1 1/4"	24	1 1/2-11	101,0	83,0	55,0
1202456	-2424	TN	24	38,0	1 1/2"	24	1 1/2-11	95,7	96,0	55,0
1202364	-2432	SN	24	38,0	1 1/2"	32	2-11	107,8	104,0	70,0
1202473	-3232	TN	32	51,0	2"	32	2-11	128,5	136,0	70,0

Dimensions shown may be changed without prior notice

// H1220581

**90° Compact BSPP Female 60° Cone
DKR 90**

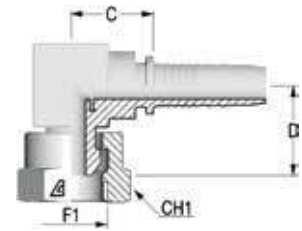

Item Code	Tail/Head	Nut Type	ID			F1	F1	C	D Drop	CH1
	Dash		Dash	mm	in	Dash Size				
1202422	-0404	CR	04	6,0	1/4"	04	1/4-19	16,8	19,5	19,0
1202025	-0606	CR	06	10,0	3/8"	06	3/8-19	18,8	22,0	22,0
1202026	-0608	CR	06	10,0	3/8"	08	1/2-14	21,5	22,5	27,0
1202027	-0808	CR	08	13,0	1/2"	08	1/2-14	22,6	24,5	27,0
1203213	-1212	CR	12	19,0	3/4"	12	3/4-14	26,7	31,0	32,0
1203330	-1616	CR	16	25,0	1"	16	1-11	34,5	27,5	38,0

// H1220613

**BSPP Female Flat Seat
DKR FD**

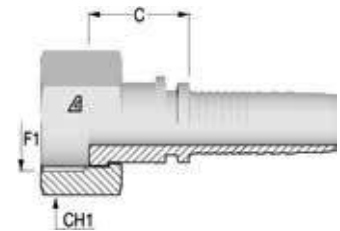

Item Code	Tail/Head	Nut Type	ID			F1	F1	C	CH1
	Dash		Dash	mm	in	Dash Size			
1202226	-0404	SN	04	6,0	1/4"	04	1/4-19	20,3	19,0
1202227	-0606	SN	06	10,0	3/8"	06	3/8-19	20,3	22,0
1202140	-0608	SN	06	10,0	3/8"	08	1/2-14	20,8	27,0
1202228	-0808	SN	08	13,0	1/2"	08	1/2-14	21,6	27,0
1202229	-0812	SN	08	13,0	1/2"	12	3/4-14	24,6	32,0
1214195	-1010	CR	10	16,0	5/8"	10	5/8-14	15,3	27,0
1201684	-1012	CR	10	16,0	5/8"	12	3/4-14	17,6	32,0
1201570	-1212	CR	12	19,0	3/4"	12	3/4-14	18,1	32,0
1216659	-1216	CR	12	19,0	3/4"	16	1-11	20,6	38,0
1201384	-1616	CR	16	25,0	1"	16	1-11	19,9	38,0

// H1230310

**BSP Banjo
RNR**

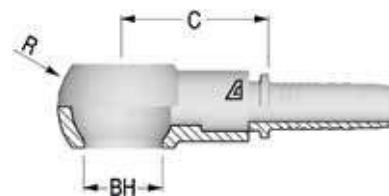

Item Code	Tail/Head		ID		F1	C	BH	R
	Dash	Dash	mm	in				
1203087	-0402	04	6,0	1/4"	1/8-28	20,0	10,10	17
1203086	-0404	04	6,0	1/4"	1/4-19	26,5	13,30	22
1216840	-0406	04	6,0	1/4"	3/8-19	30,5	16,70	28
1201763	-0506	05	8,0	5/16"	3/8-19	30,5	16,70	28
1201760	-0606	06	10,0	3/8"	3/8-19	30,5	16,70	28
1201754	-0608	06	10,0	3/8"	1/2-14	34,5	21,00	38
1216843	-0806	08	13,0	1/2"	3/8-19	30,5	16,70	28
1203048	-0808	08	13,0	1/2"	1/2-14	35,0	21,00	38
1203085	-1010	10	16,0	5/8"	5/8-14	38,0	23,00	40
1200423	-1212	12	19,0	3/4"	3/4-14	41,5	26,50	46
1203084	-1616	16	25,0	1"	1-11	50,5	33,30	58

// H10V0210

BSP Bolt

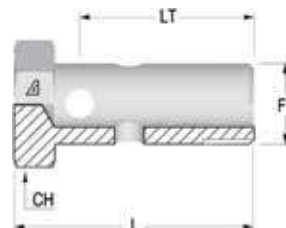

Item Code	ID	F1	LT	L	CH
	Dash				
1210365	08	1/2-14	38,0	46,0	27,0
1210366	04	1/4-19	25,0	30,0	19,0
1210367	06	3/8-19	31,0	38,0	22,0
1210402	16	1-11	58,0	69,0	38,0
1210403	12	3/4-14	47,0	56,0	32,0

Dimensions shown may be changed without prior notice

// DIN METRIC INSERTS

// H1211110

Metric Male 24° Seat - Light
DIN 3853 - CEL

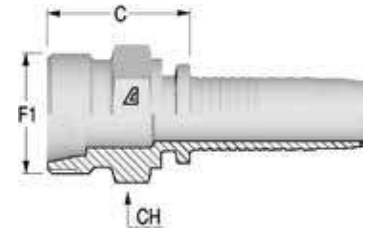

Item Code	Tail/Head Dash/mm	Nut Type	ID		F1	OD1 mm	C mm	CH mm
			Dash	mm in				
1200451	-0312	NA	03	5,0 3/16"	M12X1.5	6	20,8	14,0
1200481	-0412	NA	04	6,0 1/4"	M12X1.5	6	21,3	14,0
1200482	-0414	NA	04	6,0 1/4"	M14X1.5	8	21,3	14,0
1201558	-0416	NA	04	6,0 1/4"	M16X1.5	10	23,3	17,0
1200518	-0516	NA	05	8,0 5/16"	M16X1.5	10	23,3	17,0
1201086	-0518	NA	05	8,0 5/16"	M18X1.5	12	24,3	19,0
1200314	-0616	NA	06	10,0 3/8"	M16X1.5	10	23,3	17,0
1200315	-0618	NA	06	10,0 3/8"	M18X1.5	12	24,3	19,0
1200320	-0622	NA	06	10,0 3/8"	M22X1.5	15	25,3	22,0
1202565	-0818	NA	08	13,0 1/2"	M18X1.5	12	25,1	19,0
1200358	-0822	NA	08	13,0 1/2"	M22X1.5	15	26,1	22,0
1200362	-0826	NA	08	13,0 1/2"	M26X1.5	18	27,1	27,0
1200401	-1026	NA	10	16,0 5/8"	M26X1.5	18	27,1	27,0
1200432	-1230	NA	12	19,0 3/4"	M30X2	22	31,6	32,0
1201372	-1636	NA	16	25,0 1"	M36X2	28	34,4	36,0
1201373	-2045	NA	20	32,0 1 1/4"	M45X2	35	40,0	46,0
1201374	-2452	NA	24	38,0 1 1/2"	M52X2	42	42,0	55,0

// H1221513

**Metric Female 24° Cone with O-Ring - Light
DIN 3865 - DKOL**

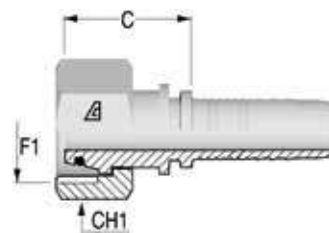

Item Code	Tail/Head Dash/mm	Nut Type	ID			F1	OD1 mm	C mm	CH1 mm
			Dash	mm	in				
1200595	-0312	SN	03	5,0	3/16"	M12X1.5	6	23,9	14,0
1240278	-0414	TN	04	6,0	1/4"	M14X1.5	6	22,9	17,0
1200609	-0416	SN	04	6,0	1/4"	M16X1.5	10	25,4	19,0
1201060	-0418	SN	04	6,0	1/4"	M18X1.5	12	25,4	22,0
1238160	-0514	TN	05	8,0	5/16"	M14X1.5	8	47,7	17,0
1240279	-0516	TN	05	8,0	5/16"	M16X1.5	10	23,2	19,0
1200643	-0518	SN	05	8,0	5/16"	M18X1.5	12	25,4	22,0
1238161	-0616	TN	06	10,0	3/8"	M16X1.5	10	25,4	19,0
1200667	-0618	SN	06	10,0	3/8"	M18X1.5	12	25,4	22,0
1200670	-0622	SN	06	10,0	3/8"	M22X1.5	15	27,4	27,0
1238162	-0818	TN	08	13,0	1/2"	M18X1.5	12	24,0	22,0
1240280	-0822	TN	08	13,0	1/2"	M22X1.5	15	25,3	27,0
1201843	-0826	SN	08	13,0	1/2"	M26X1.5	18	29,2	32,0
1238163	-1022	TN	10	16,0	5/8"	M22X1.5	15	25,3	27,0
1240281	-1026	TN	10	16,0	5/8"	M26X1.5	18	25,0	32,0
1239646	-1226	TN	12	19,0	3/4"	M26X1.5	18	25,5	32,0
1200762	-1230	SN	12	19,0	3/4"	M30X2	22	31,7	36,0
1220609	-1236	SN	12	19,0	3/4"	M36X2	28	32,8	41,0
1201593	-1630	TN	16	25,0	1"	M30X2	22	44,6	36,0
1201385	-1636	SN	16	25,0	1"	M36X2	28	33,6	41,0
1225980	-1645	SN	16	25,0	1"	M45X2	35	38,5	50,0
1201386	-2045	SN	20	32,0	1 1/4"	M45X2	35	40,1	50,0
1201387	-2452	SN	24	38,0	1 1/2"	M52X2	42	40,5	60,0

Dimensions shown may be changed without prior notice

// H1221543

**45° Metric Female 24° Cone with O-Ring - Light
DIN 3865 - DKOL 45
Solid one piece**

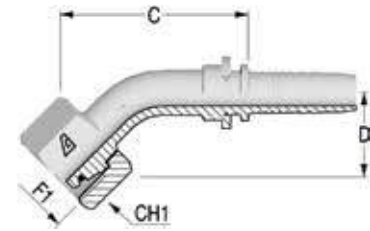

Item Code	Tail/Head Dash/mm	Nut Type	ID			F1	OD1 mm	C mm	D Drop mm	CH1 mm
			Dash	mm	in					
1200594	-0312	SN	03	5,0	3/16"	M12X1.5	6	44,9	19,0	14,0
1216676	-0412	CR	04	6,0	1/4"	M12X1.5	6	45,2	15,5	14,0
1200612	-0414	SN	04	6,0	1/4"	M14X1.5	8	43,0	17,5	17,0
1201576	-0416	SN	04	6,0	1/4"	M16X1.5	10	42,0	20,0	19,0
1225984	-0514	SN	05	8,0	5/16"	M14X1.5	8	47,5	20,0	17,0
1200645	-0516	SN	05	8,0	5/16"	M16X1.5	10	47,5	20,0	19,0
1200646	-0518	SN	05	8,0	5/16"	M18X1.5	12	47,0	22,0	22,0
1239647	-0616	TN	06	10,0	3/8"	M16X1.5	10	43,0	19,0	19,0
1200671	-0618	SN	06	10,0	3/8"	M18X1.5	12	46,8	19,5	22,0
1239971	-0818	TN	08	13,0	1/2"	M18X1.5	12	52,0	23,0	22,0
1200711	-0822	SN	08	13,0	1/2"	M22X1.5	15	55,0	21,0	27,0
1200738	-1026	SN	10	16,0	5/8"	M26X1.5	18	65,3	24,0	32,0
1240723	-1226	TN	12	19,0	3/4"	M26X1.5	20	77,0	34,0	32,0
1200764	-1230	SN	12	19,0	3/4"	M30X2	22	69,4	32,0	36,0
1225983	-1630	TN	16	25,0	1"	M30X2	22	71,1	29,0	36,0
1201390	-1636	SN	16	25,0	1"	M36X2	28	91,4	32,0	41,0
1201392	-2045	SN	20	32,0	1 1/4"	M45X2	35	141,5	45,0	50,0
1202128	-2452	SN	24	38,0	1 1/2"	M52X2	42	114,1	47,0	60,0

// H1221593

**90° Metric Female 24° Cone with O-Ring - Light
DIN 3865 - DKOL 90
Solid one piece**

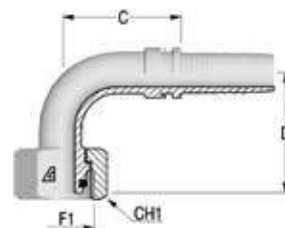

Item Code	Tail/Head Dash/mm	Nut Type	ID			F1	OD1 mm	C mm	D Drop mm	CH1 mm
			Dash	mm	in					
1200597	-0312	SN	03	5,0	3/16"	M12X1.5	6	23,6	33,0	14,0
1239994	-0412	TN	04	6,0	1/4"	M12X1.5	6	29,0	34,0	14,0
1200618	-0414	SN	04	6,0	1/4"	M14X1.5	8	28,3	32,5	17,0
1200616	-0416	SN	04	6,0	1/4"	M16X1.5	10	28,3	32,5	19,0
1203218	-0418	SN	04	6,0	1/4"	M18X1.5	12	28,8	35,0	22,0
1200648	-0516	SN	05	8,0	5/16"	M16X1.5	10	33,7	38,0	19,0
1200649	-0518	SN	05	8,0	5/16"	M18X1.5	12	32,2	40,0	22,0
1239648	-0616	TN	06	10,0	3/8"	M16X1.5	10	35,0	36,0	19,0
1200676	-0618	SN	06	10,0	3/8"	M18X1.5	12	32,8	39,0	22,0
1200679	-0622	SN	06	10,0	3/8"	M22X1.5	15	35,8	38,5	27,0
1238173	-0818	TN	08	13,0	1/2"	M18X1.5	12	42,0	44,0	22,0
1200713	-0822	SN	08	13,0	1/2"	M22X1.5	15	39,8	40,5	27,0
1203154	-0826	SN	08	13,0	1/2"	M26X1.5	18	39,8	41,0	32,0
1201292	-1022	SN	10	16,0	5/8"	M22X1.5	15	51,4	47,0	27,0
1200740	-1026	SN	10	16,0	5/8"	M26X1.5	18	51,4	48,0	32,0
1200742	-1030	SN	10	16,0	5/8"	M30X2	22	52,4	49,0	36,0
1239736	-1226	TN	12	19,0	3/4"	M26X1.5	18	60,0	64,0	32,0
1200767	-1230	SN	12	19,0	3/4"	M30X2	22	52,1	59,0	36,0
1216685	-1236	SN	12	19,0	3/4"	M36X2	28	60,0	63,0	41,0
1225987	-1630	TN	16	25,0	1"	M30X2	22	66,0	64,0	36,0
1201391	-1636	SN	16	25,0	1"	M36X2	28	75,0	68,0	41,0
1216679	-2036	TN	20	32,0	1 1/4"	M36X2	28	92,2	86,0	41,0
1201393	-2045	SN	20	32,0	1 1/4"	M45X2	35	90,5	89,0	50,0
1201394	-2452	SN	24	38,0	1 1/2"	M52X2	42	106,5	100,0	60,0

Dimensions shown may be changed without prior notice

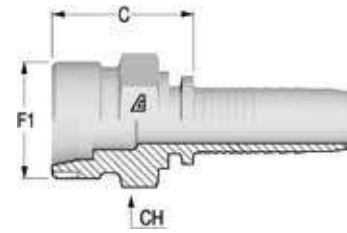
// H1211210
**Metric Male 24° Seat - Heavy
DIN 3853 - CES**

Item Code	Tail/Head Dash/mm	Nut Type	ID			F1	OD1 mm	C mm	CH mm
			Dash	mm	in				
1201828	-0414	NA	04	6,0	1/4"	M14X1.5	6	24,3	17,0
1200485	-0416	NA	04	6,0	1/4"	M16X1.5	8	24,3	17,0
1200477	-0418	NA	04	6,0	1/4"	M18X1.5	10	25,3	19,0
1200521	-0520	NA	05	8,0	5/16"	M20X1.5	12	25,3	22,0
1202267	-0618	NA	06	10,0	3/8"	M18X1.5	10	25,3	19,0
1200316	-0620	NA	06	10,0	3/8"	M20X1.5	12	25,3	22,0
1200319	-0622	NA	06	10,0	3/8"	M22X1.5	14	27,3	22,0
1221728	-0624	NA	06	10,0	3/8"	M24X1.5	16	28,1	24,0
1202564	-0822	NA	08	13,0	1/2"	M22X1.5	14	28,1	22,0
1200360	-0824	NA	08	13,0	1/2"	M24X1.5	16	29,1	24,0
1200364	-0830	NA	08	13,0	1/2"	M30X2	20	33,1	32,0
1200403	-1030	NA	10	16,0	5/8"	M30X2	20	33,1	32,0
1202526	-1230	NA	12	19,0	3/4"	M30X2	20	33,6	32,0
1200434	-1236	NA	12	19,0	3/4"	M36X2	25	37,6	36,0
1203151	-1636	NA	16	25,0	1"	M36X2	25	38,4	36,0
1201375	-1642	NA	16	25,0	1"	M42X2	30	42,4	46,0
1201376	-2052	NA	20	32,0	1 1/4"	M52X2	38	48,0	55,0

// H1221613

**Metric Female 24° Cone with O-Ring - Heavy
DIN 3865 - DKOS**

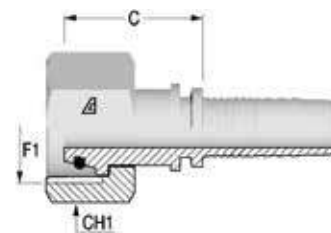

Item Code	Tail/Head Dash/mm	Nut Type	ID			F1	OD1	C	CH1
			Dash	mm	in				
1200596	-0316	SN	03	5,0	3/16"	M16X1.5	8	27,2	19,0
1201827	-0414	SN	04	6,0	1/4"	M14X1.5	6	26,4	17,0
1200615	-0416	SN	04	6,0	1/4"	M16X1.5	8	27,7	19,0
1200610	-0418	SN	04	6,0	1/4"	M18X1.5	10	27,6	22,0
1201061	-0420	SN	04	6,0	1/4"	M20X1.5	12	27,6	24,0
1201832	-0518	SN	05	8,0	5/16"	M18X1.5	10	27,6	22,0
1200644	-0520	SN	05	8,0	5/16"	M20X1.5	12	27,6	24,0
1239671	-0616	TN	06	10,0	3/8"	M16X1.5	8	23,2	19,0
1238179	-0618	TN	06	10,0	3/8"	M18X1.5	10	22,3	22,0
1200668	-0620	SN	06	10,0	3/8"	M20X1.5	12	27,6	24,0
1200669	-0622	SN	06	10,0	3/8"	M22X1.5	14	31,1	27,0
1202570	-0624	SN	06	10,0	3/8"	M24X1.5	16	30,9	30,0
1239650	-0820	TN	08	13,0	1/2"	M20X1.5	12	23,2	24,0
1218557	-0822	SN	08	13,0	1/2"	M22X1.5	14	31,9	27,0
1200708	-0824	SN	08	13,0	1/2"	M24X1.5	16	31,7	30,0
1200710	-0830	SN	08	13,0	1/2"	M30X2	20	36,5	36,0
1239651	-1024	TN	10	16,0	5/8"	M24X1.5	16	25,3	30,0
1200737	-1030	SN	10	16,0	5/8"	M30X2	20	36,5	36,0
1201732	-1230	SN	12	19,0	3/4"	M30X2	20	37,0	36,0
1216696	-1236	SN	12	19,0	3/4"	M36X2	25	40,2	41,0
1200763	-1236	SN	12	19,0	3/4"	M36X2	25	40,2	46,0
1239744	-1630	TN	16	25,0	1"	M30X2	20	29,8	36,0
1203099	-1636	SN	16	25,0	1"	M36X2	25	41,0	46,0
1201388	-1642	SN	16	25,0	1"	M42X2	30	43,1	50,0
1216693	-2042	SN	20	32,0	1 1/4"	M42X2	30	44,7	50,0
1201389	-2052	SN	20	32,0	1 1/4"	M52X2	38	48,1	60,0
1216695	-2452	SN	24	38,0	1 1/2"	M52X2	38	48,1	60,0

Dimensions shown may be changed without prior notice

// H1221643

**45° Metric Female 24° Cone with O-Ring - Heavy
DIN 3865 - DKOS 45
Solid one piece**

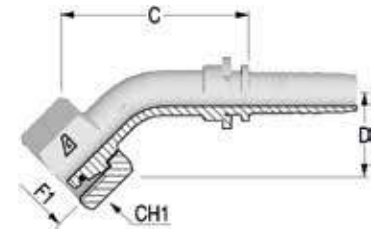

Item Code	Tail/Head Dash/mm	Nut Type	ID			F1	OD1 mm	C mm	D Drop mm	CH1 mm
			Dash	mm	in					
1216697	-0414	SN	04	6,0	1/4"	M14X1.5	6	47,0	20,0	17,0
1200613	-0416	SN	04	6,0	1/4"	M16X1.5	8	48,6	16,0	19,0
1200611	-0418	SN	04	6,0	1/4"	M18X1.5	10	43,5	19,0	22,0
1240698	-0518	SN	05	8,0	5/16"	M18X1.5	10	46,0	18,0	22,0
1200647	-0520	SN	05	8,0	5/16"	M20X1.5	12	48,1	21,0	24,0
1226010	-0616	SN	06	10,0	3/8"	M16X1.5	8	50,6	21,0	19,0
1239968	-0618	TN	06	10,0	3/8"	M18X1.5	10	47,0	21,0	22,0
1200672	-0620	SN	06	10,0	3/8"	M20X1.5	12	50,6	20,0	24,0
1200673	-0622	SN	06	10,0	3/8"	M22X1.5	14	52,9	21,0	27,0
1242602	-0820	TN	08	13,0	1/2"	M20X1.5	12	54,0	24,0	24,0
1200712	-0824	SN	08	13,0	1/2"	M24X1.5	16	55,8	21,5	30,0
1201300	-1030	SN	10	16,0	5/8"	M30X2	20	66,3	30,0	36,0
1202891	-1230	SN	12	19,0	3/4"	M30X2	20	66,1	29,0	36,0
1200765	-1236	SN	12	19,0	3/4"	M36X2	25	69,5	33,0	46,0
1203098	-1636	SN	16	25,0	1"	M36X2	25	89,7	36,0	46,0
1201395	-1642	SN	16	25,0	1"	M42X2	30	110,3	40,5	50,0
1201398	-2052	SN	20	32,0	1 1/4"	M52X2	38	109,0	45,0	60,0

// H1221693

**90° Metric Female 24° Cone with O-Ring - Heavy
DIN 3865 - DKOS 90
Solid one piece**

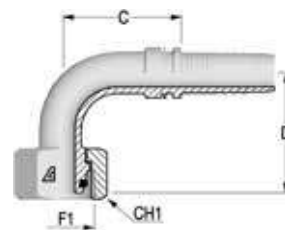

Item Code	Tail/Head Dash/mm	Nut Type	ID			F1	OD1 mm	C mm	D Drop mm	CH1 mm
			Dash	mm	in					
1201065	-0414	SN	04	6,0	1/4"	M14X1.5	6	27,3	33,0	17,0
1200619	-0416	SN	04	6,0	1/4"	M16X1.5	8	27,3	33,0	19,0
1200617	-0418	SN	04	6,0	1/4"	M18X1.5	10	26,8	34,0	22,0
1216700	-0518	SN	05	8,0	5/16"	M18X1.5	10	33,2	39,0	22,0
1200650	-0520	SN	05	8,0	5/16"	M20X1.5	12	33,2	39,0	24,0
1239989	-0616	TN	06	10,0	3/8"	M16X1.5	8	33,0	38,0	19,0
1239926	-0618	TN	06	10,0	3/8"	M18X1.5	10	35,0	38,0	22,0
1200677	-0620	SN	06	10,0	3/8"	M20X1.5	12	34,3	38,5	24,0
1200678	-0622	SN	06	10,0	3/8"	M22X1.5	14	34,3	40,5	27,0
1240110	-0820	TN	08	13,0	1/2"	M20X1.5	12	40,0	45,0	24,0
1200714	-0824	SN	08	13,0	1/2"	M24X1.5	16	39,8	41,5	30,0
1201253	-0830	SN	08	13,0	1/2"	M30X2	20	45,8	50,0	36,0
1240088	-1024	TN	10	16,0	5/8"	M24X1.5	16	52,0	56,0	30,0
1200741	-1030	SN	10	16,0	5/8"	M30X2	20	47,9	55,0	36,0
1200766	-1230	SN	12	19,0	3/4"	M30X2	20	50,6	58,0	36,0
1200768	-1236	SN	12	19,0	3/4"	M36X2	25	50,6	59,5	46,0
1203097	-1636	SN	16	25,0	1"	M36X2	25	77,6	73,5	46,0
1201396	-1642	SN	16	25,0	1"	M42X2	30	75,6	79,0	50,0
1201397	-2052	SN	20	32,0	1 1/4"	M52X2	38	94,0	92,0	60,0

Dimensions shown may be changed without prior notice

// H1221313
Universal Metric Female

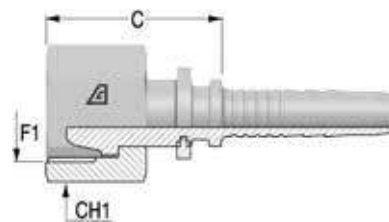

Item Code	Tail/Head	Nut Type	ID			F1	F1	C	CH1
	Dash		Dash	mm	in	Dash Size			
1200631	-0414	SN	04	6,0	1/4"	14	M14X1.5	22,3	17,0
1200632	-0416	SN	04	6,0	1/4"	16	M16X1.5	21,8	19,0
1200633	-0418	SN	04	6,0	1/4"	18	M18X1.5	22,3	22,0
1200658	-0516	SN	05	8,0	5/16"	16	M16X1.5	22,3	19,0
1200659	-0518	SN	05	8,0	5/16"	18	M18X1.5	22,3	22,0
1200697	-0616	SN	06	10,0	3/8"	16	M16X1.5	25,0	19,0
1200698	-0618	SN	06	10,0	3/8"	18	M18X1.5	22,3	22,0
1200729	-0822	SN	08	13,0	1/2"	22	M22X1.5	24,7	27,0
1200753	-1026	SN	10	16,0	5/8"	26	M26X1.5	25,1	32,0

// H1221343
45° Universal Metric Female

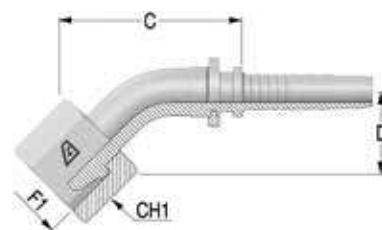

Item Code	Tail/Head	Nut Type	ID			F1	F1	C	D Drop	CH1
	Dash		Dash	mm	in	Dash Size				
1216669	-0414	SN	04	6,0	1/4"	14	M14X1.5	36,5	16,0	17,0
1216670	-0416	SN	04	6,0	1/4"	16	M16X1.5	37,0	17,0	19,0
1200660	-0516	SN	05	8,0	5/16"	16	M16X1.5	42,1	19,0	19,0
1201450	-0618	SN	06	10,0	3/8"	18	M18X1.5	42,8	20,0	22,0
1225972	-0822	SN	08	13,0	1/2"	22	M22X1.5	54,9	20,0	27,0
1225973	-1026	SN	10	16,0	5/8"	26	M26X1.5	54,0	22,0	32,0

// H1221393

90° Universal Metric Female

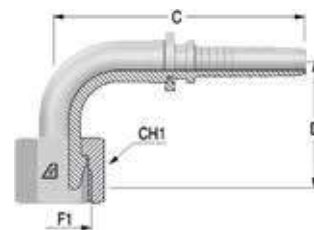

Item Code	Tail/Head	Nut Type	ID			F1	F1	C	D Drop	CH1
	Dash		Dash	mm	in	Dash Size				
1225975	-0414	SN	04	6,0	1/4"	14	M14X1.5	29,9	28,5	17,0
1201452	-0416	SN	04	6,0	1/4"	16	M16X1.5	28,3	33,0	19,0
1200661	-0516	SN	05	8,0	5/16"	16	M16X1.5	34,2	36,0	19,0
1201323	-0518	SN	05	8,0	5/16"	18	M18X1.5	34,0	32,0	22,0
1216671	-0616	SN	06	10,0	3/8"	16	M16X1.5	30,0	32,0	19,0
1200701	-0618	SN	06	10,0	3/8"	18	M18X1.5	32,8	37,0	22,0
1201580	-0622	SN	06	10,0	3/8"	22	M22X1.5	32,3	36,0	27,0
1200730	-0822	SN	08	13,0	1/2"	22	M22X1.5	39,8	40,0	27,0
1216672	-1026	SN	10	16,0	5/8"	26	M26X1.5	51,0	46,0	32,0

// H1221013

Metric Female 60° Cone - DIN 3863

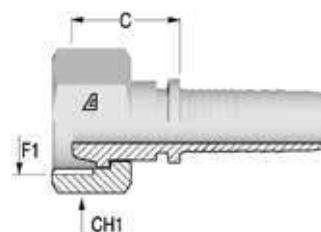

Item Code	Tail/Head	Nut Type	ID			F1	F1	C	CH1
	Dash		Dash	mm	in	Dash Size			
1200759	-1230	SN	12	19,0	3/4"	30	M30X1.5	21,6	36,0
1201572	-1638	SN	16	25,0	1"	38	M38X1.5	28,0	46,0

// H1221093

**90° Metric Female 60° Cone - DIN 3863
Solid one piece**

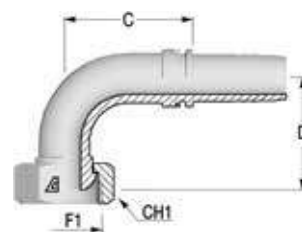

Item Code	Tail/Head	Nut Type	ID			F1	F1	C	D Drop	CH1
	Dash		Dash	mm	in	Dash Size				
1202056	-1230	SN	12	19,0	3/4"	30	M30X1.5	54,6	47,0	36,0
1201620	-1638	SN	16	25,0	1"	38	M38X1.5	72,6	60,0	46,0

Dimensions shown may be changed without prior notice

// H1252010

**Metric Straight Standpipe - DIN 2353
RSL/RSS**

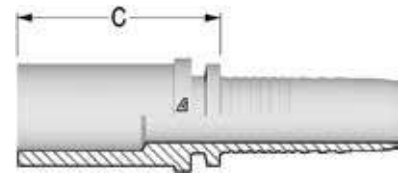

Item Code	Tail/Head	Dash	ID		OD1	C
	Dash/mm		mm	in		
1200855	-0306	03	5,0	3/16"	6	27,8
1200856	-0308	03	5,0	3/16"	8	29,8
1200865	-0406	04	6,0	1/4"	6	28,3
1200867	-0408	04	6,0	1/4"	8	30,2
1200859	-0410	04	6,0	1/4"	10	32,2
1200860	-0412	04	6,0	1/4"	12	31,2
1200878	-0508	05	8,0	5/16"	8	30,3
1200871	-0510	05	8,0	5/16"	10	30,2
1200872	-0512	05	8,0	5/16"	12	32,7
1200793	-0610	06	10,0	3/8"	10	30,3
1200794	-0612	06	10,0	3/8"	12	29,3
1200796	-0614	06	10,0	3/8"	14	35,8
1200797	-0615	06	10,0	3/8"	15	34,8
1216922	-0810	08	13,0	1/2"	10	32,5
1200809	-0812	08	13,0	1/2"	12	32,1
1200811	-0814	08	13,0	1/2"	14	36,1
1200812	-0815	08	13,0	1/2"	15	32,1
1200813	-0816	08	13,0	1/2"	16	37,1
1200815	-0818	08	13,0	1/2"	18	36,0
1200828	-1018	10	16,0	5/8"	18	34,2
1200829	-1020	10	16,0	5/8"	20	44,2
1200832	-1022	10	16,0	5/8"	22	37,2
1200838	-1220	12	19,0	3/4"	20	45,5
1200840	-1222	12	19,0	3/4"	22	36,5
1200841	-1225	12	19,0	3/4"	25	48,5
1201442	-1625	16	25,0	1"	25	51,4
1201440	-1628	16	25,0	1"	28	40,4
1201441	-1630	16	25,0	1"	30	54,4
1214227	-1638	16	25,0	1"	38	60,4
1214228	-2030	20	32,0	1 1/4"	30	56,0
1201443	-2035	20	32,0	1 1/4"	35	48,0
1201444	-2038	20	32,0	1 1/4"	38	62,0
1203082	-2438	24	38,0	1 1/2"	38	62,0
1201445	-2442	24	38,0	1 1/2"	42	52,0

// H1252040

**45° Metric Standpipe
RSL 45/RSS 45 - DIN 2353
Solid one piece**

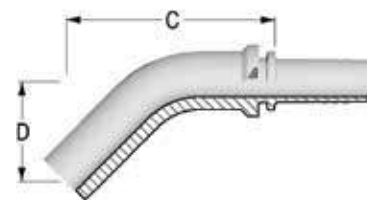

Item Code	Tail/Head	Dash	ID		OD1	C	D Drop
	Dash/mm		mm	in			
1200863	-0406	04	6,0	1/4"	6	50,1	28,0
1200864	-0408	04	6,0	1/4"	8	43,2	23,0
1200862	-0410	04	6,0	1/4"	10	48,0	24,0
1200876	-0510	05	8,0	5/16"	10	48,4	24,0
1200877	-0512	05	8,0	5/16"	12	55,4	28,0
1200800	-0610	06	10,0	3/8"	10	48,5	24,0
1200801	-0612	06	10,0	3/8"	12	55,5	28,0
1200802	-0614	06	10,0	3/8"	14	53,1	28,0
1200817	-0815	08	13,0	1/2"	15	62,6	28,5
1200818	-0816	08	13,0	1/2"	16	63,3	32,0
1214229	-0818	08	13,0	1/2"	18	72,0	30,5
1200843	-1222	12	19,0	3/4"	22	74,3	37,0
1200844	-1225	12	19,0	3/4"	25	83,0	44,0
1216924	-1625	16	25,0	1"	25	102,3	55,0
1214232	-1630	16	25,0	1"	30	137,0	46,1

Dimensions shown may be changed without prior notice

// H1252090

**90° Metric Standpipe
RSL 90/RSS 90 - DIN 2353
Solid one piece**

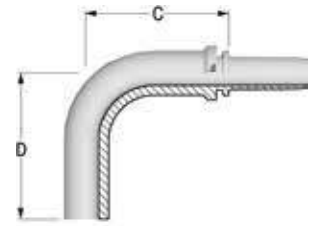

Item Code	Tail/Head	Dash	ID		OD1	C	D Drop
	Dash/mm		mm	in			
1200857	-0306	03	5,0	3/16"	6	24,5	36,0
1200869	-0406	04	6,0	1/4"	6	25,4	36,0
1200870	-0408	04	6,0	1/4"	8	25,9	44,0
1200868	-0410	04	6,0	1/4"	10	30,6	42,0
1202296	-0412	04	6,0	1/4"	12	34,9	50,0
1200879	-0510	05	8,0	5/16"	10	28,6	48,5
1200880	-0512	05	8,0	5/16"	12	39,4	55,0
1200803	-0610	06	10,0	3/8"	10	30,7	42,0
1200804	-0612	06	10,0	3/8"	14	35,0	50,0
1200805	-0614	06	10,0	3/8"	14	37,0	50,0
1218454	-0812	08	13,0	1/2"	12	41,1	52,0
1200822	-0815	08	13,0	1/2"	15	44,7	57,0
1200823	-0816	08	13,0	1/2"	16	43,7	64,0
1203079	-0818	08	13,0	1/2"	18	58,1	59,0
1200835	-1018	10	16,0	5/8"	18	52,2	58,0
1200836	-1020	10	16,0	5/8"	20	62,6	70,0
1210832	-1022	10	16,0	5/8"	22	49,4	64,0
1203081	-1220	12	19,0	3/4"	20	63,4	70,0
1200846	-1222	12	19,0	3/4"	22	53,1	67,5
1200847	-1225	12	19,0	3/4"	25	63,2	85,0
1214233	-1625	16	25,0	1"	25	73,1	98,5
1202886	-1628	16	25,0	1"	28	73,1	89,5
1214234	-1630	16	25,0	1"	30	73,1	102,5
1214235	-2035	20	32,0	1 1/4"	35	89,0	106,5

// H1230910

**Metric Banjo
RNM**

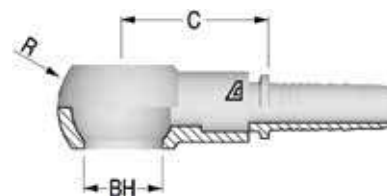

Item Code	Tail/Head	Dash	ID		F1	C	BH	R
	Dash		mm	in		mm	mm	mm
1202577	-0310	03	5,0	3/16"	M10X1.0	24,0	10,00	17
1200468	-0410	04	6,0	1/4"	M10X1.0	25,0	10,00	17
1200469	-0412	04	6,0	1/4"	M12X1.5	28,5	12,00	20
1200470	-0414	04	6,0	1/4"	M14X1.5	27,5	14,00	24
1200513	-0512	05	8,0	5/16"	M12X1.5	28,5	12,00	24
1200514	-0514	05	8,0	5/16"	M14X1.5	27,5	14,00	24
1200515	-0516	05	8,0	5/16"	M16X1.5	30,5	16,00	28
1200516	-0518	05	8,0	5/16"	M18X1.5	28,5	18,00	32
1200309	-0614	06	10,0	3/8"	M14X1.5	27,5	14,00	24
1200310	-0616	06	10,0	3/8"	M16X1.5	30,5	16,00	28
1200311	-0618	06	10,0	3/8"	M18X1.5	31,5	18,00	32
1200346	-0818	08	13,0	1/2"	M18X1.5	32,0	18,00	32
1200347	-0822	08	13,0	1/2"	M22X1.5	35,0	22,00	39
1200389	-1022	10	16,0	5/8"	M22X1.5	35,0	22,00	39
1200422	-1226	12	19,0	3/4"	M26X1.5	38,5	26,00	46
1203083	-1630	16	25,0	1"	M30X1.5	42,5	30,00	54

// H10V0810

Metric Bolt

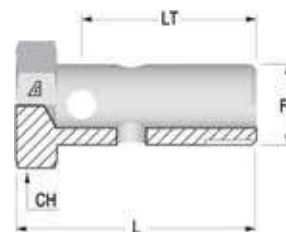

Item Code	ID	F1	LT	L	CH
	Dash		mm	mm	mm
1210405	30	M30X1.5	51,0	62,0	38,0
1210406	26	M26X1.5	42,0	52,0	32,0
1210371	22	M22X1.5	41,0	48,0	27,0
1210384	16	M16X1.5	34,0	41,0	22,0
1210374	10	M10X1.0	19,0	24,0	14,0
1210375	12	M12X1.5	24,0	29,0	17,0
1210368	14	M14X1.5	28,0	34,0	19,0
1210369	18	M18X1.5	37,0	44,0	24,0

Dimensions shown may be changed without prior notice

// PRESSURE WASHER

// H1224914

Universal Female for Pressure Washer

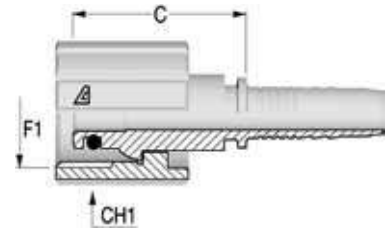

Item Code	Tail/Head	Nut Type	ID			F1	F1	C	CH1
	Dash		Dash	mm	in	Dash Size			
1203350	-0422	TN	04	6,0	1/4"	22	M22X1.5	36,8	35,0
1203351	-0522	TN	05	8,0	5/16"	22	M22X1.5	36,8	35,0
1203352	-0622	TN	06	10,0	3/8"	22	M22X1.5	36,8	35,0

// SAE INSERTS

// H1213B10

SAE Male Flareless

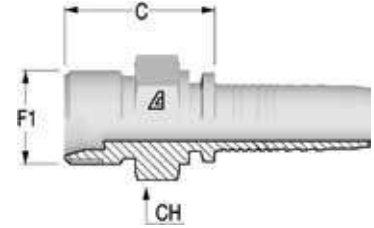

Item Code	Tail/Head	Nut Type	ID			F1	F1	C	CH
	Dash		Dash	mm	in	Dash Size			
1216628	-0404	NA	04	6,0	1/4"	04	7/16-20	21,8	12,0
1216629	-0405	NA	04	6,0	1/4"	05	1/2-20	22,8	14,0
1216630	-0506	NA	05	8,0	5/16"	06	9/16-18	24,2	16,0
1216632	-0606	NA	06	10,0	3/8"	06	9/16-18	24,2	16,0
1216633	-0808	NA	08	13,0	1/2"	08	3/4-16	28,4	22,0
1225942	-1212	NA	12	19,0	3/4"	12	1 1/16-12	33,1	30,0

// H1226611

SAE Female Swivel 45° Seat

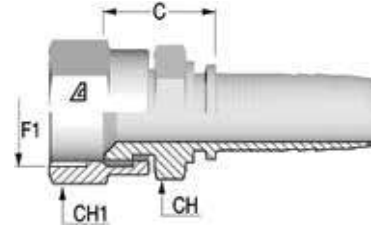

Item Code	Tail/Head	Nut Type	ID			F1	F1	C	CH	CH1
	Dash		Dash	mm	in	Dash Size				
1202661	-0606	CR	06	10,0	3/8"	06	5/8-18	23,3	19,0	22,0
1226097	-0608	CR	06	10,0	3/8"	08	3/4-16	24,8	19,0	25,0
1226098	-0810	CR	08	13,0	1/2"	10	7/8-14	26,6	22,0	27,0
1202371	-1212	CR	12	19,0	3/4"	12	1 1/16-14	28,6	27,0	32,0

// H1229710

Female Grease Connection PTF Thread

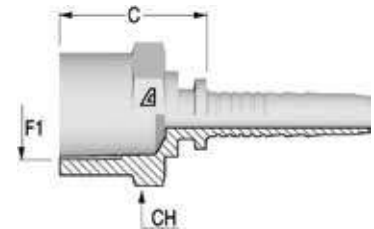

Item Code	Tail/Head	Nut Type	ID			F1	F1	C	CH
	Dash		Dash	mm	in	Dash Size			
1216837	-0404	NA	04	6,0	1/4"	04	1/2-27	23,3	19,0

Dimensions shown may be changed without prior notice

// H1213010
SAE Male Solid
O-Ring Boss

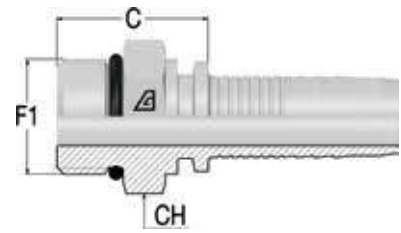

Item Code	Tail/Head	Nut Type	ID			F1	F1	C	CH
	Dash		Dash	mm	in	Dash Size			
1203147	-0404	NA	04	6,0	1/4"	04	7/16-20	20,3	14,0
1201833	-0405	NA	04	6,0	1/4"	05	1/2-20	21,3	16,0
1202519	-0406	NA	04	6,0	1/4"	06	9/16-18	22,3	17,0
1201834	-0606	NA	06	10,0	3/8"	06	9/16-18	23,3	19,0
1200337	-0608	NA	06	10,0	3/8"	08	3/4-16	24,3	22,0
1200338	-0610	NA	06	10,0	3/8"	10	7/8-14	26,8	27,0
1200382	-0808	NA	08	13,0	1/2"	08	3/4-16	25,1	22,0
1200383	-0810	NA	08	13,0	1/2"	10	7/8-14	27,6	27,0
1200381	-0812	NA	08	13,0	1/2"	12	1 1/16-12	32,1	32,0
1221652	-1010	NA	10	16,0	5/8"	10	7/8-14	27,6	24,0
1200416	-1012	NA	10	16,0	5/8"	12	1 1/16-12	32,1	32,0
1203146	-1210	NA	12	19,0	3/4"	10	7/8-14	28,1	27,0
1200445	-1212	NA	12	19,0	3/4"	12	1 1/16-12	32,6	32,0
1201836	-1616	NA	16	25,0	1"	16	1 5/16-12	35,4	38,0
1225859	-2020	NA	20	32,0	1 1/4"	20	1 5/8-12	39,0	46,0

// H1213011
SAE Male Swivel
O-Ring Boss

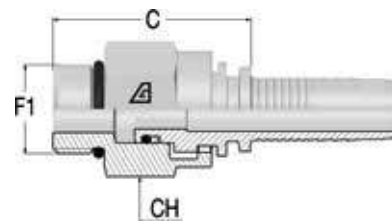

Item Code	Tail/Head	Nut Type	ID			F1	F1	C	CH
	Dash		Dash	mm	in	Dash Size			
1225927	-0606	CR	06	10,0	3/8"	06	9/16-18	40,5	22,0
1225928	-0608	CR	06	10,0	3/8"	08	3/4-16	22,0	22,0
1225929	-0808	CR	08	13,0	1/2"	08	3/4-16	23,0	25,0
1225930	-0810	CR	08	13,0	1/2"	10	7/8-14	23,0	25,0
1230553	-1212	CR	12	19,0	3/4"	12	1 1/16-12	49,6	32,0

// H1213081
90° Compact SAE Male Swivel
O-Ring Boss

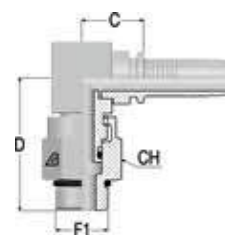

Item Code	Tail/Head	Nut Type	ID			F1	F1	C	D Drop	CH
	Dash		Dash	mm	in	Dash Size				
1226490	-0405	CR	04	6,0	1/4"	05	1/2-20	17,0	34,0	17,0
1225933	-0608	CR	06	10,0	3/8"	08	3/4-16	22,0	44,0	25,0
1225934	-0808	CR	08	13,0	1/2"	08	3/4-16	23,0	47,0	25,0
1225935	-0810	CR	08	13,0	1/2"	10	7/8-14	23,0	49,0	25,0
1226492	-1212	CR	12	19,0	3/4"	12	1 1/16-12	27,0	61,0	32,0
1240593	-1616	CR	16	25,0	1"	16	1 5/16-12	34,4	67,5	41,0

Dimensions shown may be changed without prior notice

// JIC 37° INSERTS

// H1212510

**JIC Male 37° Cone
AGJ**

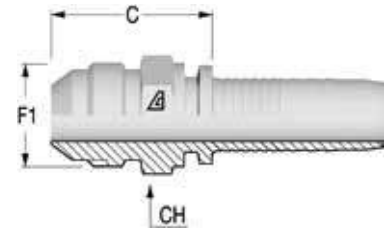

Item Code	Tail/Head	Nut Type	ID			F1	F1	C	CH
	Dash		Dash	mm	in	Dash Size			
1200457	-0304	NA	03	5,0	3/16"	04	7/16-20	23,8	12,0
1200500	-0404	NA	04	6,0	1/4"	04	7/16-20	25,3	12,0
1200499	-0405	NA	04	6,0	1/4"	05	1/2-20	25,3	14,0
1200501	-0406	NA	04	6,0	1/4"	06	9/16-18	26,3	17,0
1200534	-0505	NA	05	8,0	5/16"	05	1/2-20	25,3	14,0
1200535	-0506	NA	05	8,0	5/16"	06	9/16-18	26,3	17,0
1201087	-0508	NA	05	8,0	5/16"	08	3/4-16	29,8	19,0
1200332	-0606	NA	06	10,0	3/8"	06	9/16-18	26,3	17,0
1200330	-0608	NA	06	10,0	3/8"	08	3/4-16	29,8	19,0
1200331	-0610	NA	06	10,0	3/8"	10	7/8-14	33,8	24,0
1200375	-0808	NA	08	13,0	1/2"	08	3/4-16	30,6	19,0
1200376	-0810	NA	08	13,0	1/2"	10	7/8-14	34,6	24,0
1200374	-0812	NA	08	13,0	1/2"	12	1 1/16-12	37,1	27,0
1200413	-1010	NA	10	16,0	5/8"	10	7/8-14	34,6	24,0
1200411	-1012	NA	10	16,0	5/8"	12	1 1/16-12	37,1	27,0
1200441	-1212	NA	12	19,0	3/4"	12	1 1/16-12	37,6	27,0
1200442	-1214	NA	12	19,0	3/4"	14	1 3/16-12	40,1	32,0
1200443	-1216	NA	12	19,0	3/4"	16	1 5/16-12	42,6	36,0
1222989	-1612	NA	16	25,0	1"	12	1 1/16-12	40,4	32,0
1201379	-1616	NA	16	25,0	1"	16	1 5/16-12	43,4	36,0
1201380	-1620	NA	16	25,0	1"	20	1 5/8-12	46,9	46,0
1201381	-2020	NA	20	32,0	1 1/4"	20	1 5/8-12	48,5	46,0
1201785	-2024	NA	20	32,0	1 1/4"	24	1 7/8-12	52,5	50,0
1201382	-2424	NA	24	38,0	1 1/2"	24	1 7/8-12	52,5	50,0
1201383	-3232	NA	32	51,0	2"	32	2 1/2-12	62,0	65,0

// H1222511

JIC Female 37° Seat
DKJ

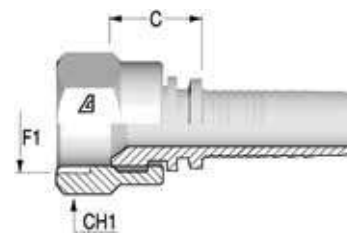

Item Code	Tail/Head	Nut Type	ID			F1	F1	C	CH1
	Dash		Dash	mm	in	Dash Size			
1200600	-0304	CR	03	5,0	3/16"	04	7/16-20	14,3	16,0
1200625	-0404	CR	04	6,0	1/4"	04	7/16-20	14,6	16,0
1200623	-0405	CR	04	6,0	1/4"	05	1/2-20	15,3	17,0
1200626	-0406	CR	04	6,0	1/4"	06	9/16-18	15,3	19,0
1200655	-0505	CR	05	8,0	5/16"	05	1/2-20	15,3	17,0
1200656	-0506	CR	05	8,0	5/16"	06	9/16-18	15,3	19,0
1200691	-0606	CR	06	10,0	3/8"	06	9/16-18	15,3	19,0
1200687	-0608	CR	06	10,0	3/8"	08	3/4-16	17,8	25,0
1200690	-0610	CR	06	10,0	3/8"	10	7/8-14	20,3	27,0
1200723	-0808	CR	08	13,0	1/2"	08	3/4-16	18,6	25,0
1200725	-0810	CR	08	13,0	1/2"	10	7/8-14	19,6	27,0
1200722	-0812	CR	08	13,0	1/2"	12	1 1/16-12	22,1	32,0
1200751	-1010	CR	10	16,0	5/8"	10	7/8-14	19,6	27,0
1200749	-1012	CR	10	16,0	5/8"	12	1 1/16-12	20,1	32,0
1201841	-1210	CR	12	19,0	3/4"	10	7/8-14	20,1	27,0
1200774	-1212	CR	12	19,0	3/4"	12	1 1/16-12	20,6	32,0
1200775	-1214	CR	12	19,0	3/4"	14	1 3/16-12	19,9	36,0
1200776	-1216	CR	12	19,0	3/4"	16	1 5/16-12	22,1	38,0
1201399	-1612	CR	16	25,0	1"	12	1 1/16-12	22,4	32,0
1201400	-1616	CR	16	25,0	1"	16	1 5/16-12	23,9	38,0
1201401	-1620	TN	16	25,0	1"	20	1 5/8-12	26,5	50,0
1202820	-2016	CR	20	32,0	1 1/4"	16	1 5/16-12	26,5	38,0
1201402	-2020	TN	20	32,0	1 1/4"	20	1 5/8-12	28,1	50,0
1201403	-2024	TN	20	32,0	1 1/4"	24	1 7/8-12	30,4	55,0
1201097	-2424	TN	24	38,0	1 1/2"	24	1 7/8-12	29,4	55,0
1203249	-3224	TN	32	51,0	2"	24	1 7/8-12	31,4	55,0
1201404	-3232	TN	32	51,0	2"	32	2 1/2-12	32,0	-

Dimensions shown may be changed without prior notice

// H1226511

**JIC Female 37° Seat with Stem Hexagon
DKJ**

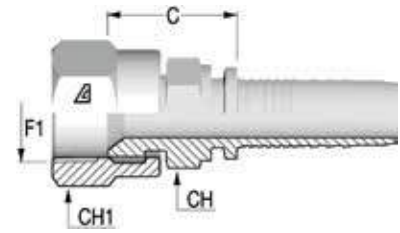

Item Code	Tail/Head	Nut Type	ID			F1	F1	C	CH	CH1
	Dash		Dash	mm	in	Dash Size		mm	mm	mm
1200599	-0304	CR	03	5,0	3/16"	04	7/16-20	18,1	12,0	16,0
1200621	-0404	CR	04	6,0	1/4"	04	7/16-20	19,6	14,0	16,0
1202406	-0405	CR	04	6,0	1/4"	05	1/2-20	20,3	14,0	17,0
1200622	-0406	CR	04	6,0	1/4"	06	9/16-18	20,3	14,0	19,0
1201497	-0505	CR	05	8,0	5/16"	05	1/2-20	20,3	14,0	17,0
1201264	-0506	CR	05	8,0	5/16"	06	9/16-18	20,3	14,0	19,0
1203246	-0604	CR	06	10,0	3/8"	04	7/16-20	20,6	17,0	16,0
1223146	-0605	CR	06	10,0	3/8"	05	1/2-20	21,3	16,0	17,0
1200686	-0606	CR	06	10,0	3/8"	06	9/16-18	21,3	17,0	19,0
1200685	-0608	CR	06	10,0	3/8"	08	3/4-16	24,8	19,0	25,0
1201340	-0610	CR	06	10,0	3/8"	10	7/8-14	25,8	22,0	27,0
1203090	-0806	CR	08	13,0	1/2"	06	9/16-18	23,1	19,0	19,0
1200720	-0808	CR	08	13,0	1/2"	08	3/4-16	25,6	19,0	25,0
1200721	-0810	CR	08	13,0	1/2"	10	7/8-14	26,6	22,0	27,0
1210833	-0812	CR	08	13,0	1/2"	12	1 1/16-12	28,1	25,0	32,0
1216811	-1006	CR	10	16,0	5/8"	06	9/16-18	24,1	24,0	19,0
1203329	-1008	CR	10	16,0	5/8"	08	3/4-16	26,6	24,0	25,0
1201728	-1010	CR	10	16,0	5/8"	10	7/8-14	27,6	24,0	27,0
1201464	-1012	CR	10	16,0	5/8"	12	1 1/16-12	28,1	25,0	32,0
1202895	-1210	CR	12	19,0	3/4"	10	7/8-14	28,1	27,0	27,0
1201333	-1212	CR	12	19,0	3/4"	12	1 1/16-12	28,6	27,0	32,0
1214219	-1214	CR	12	19,0	3/4"	14	1 3/16-12	29,9	32,0	36,0
1203089	-1216	CR	12	19,0	3/4"	16	1 5/16-12	32,1	32,0	38,0
1203243	-1416	CR	14	22,0	7/8"	16	1 5/16-12	32,1	32,0	38,0
1203088	-1612	CR	16	25,0	1"	12	1 1/16-12	31,4	32,0	32,0
1202408	-1616	CR	16	25,0	1"	16	1 5/16-12	32,9	32,0	38,0
1214220	-1620	TN	16	25,0	1"	20	1 5/8-12	37,5	41,0	50,0
1216813	-1820	TN	-	29,0	1 1/8"	20	1 5/8-12	37,5	41,0	50,0
1216812	-2016	CR	20	32,0	1 1/4"	16	1 5/16-12	37,5	41,0	38,0
1202483	-2020	TN	20	32,0	1 1/4"	20	1 5/8-12	39,1	41,0	50,0
1226093	-2024	TN	20	32,0	1 1/4"	24	1 7/8-12	43,4	50,0	55,0
1216814	-2224	TN	-	35,0	1 3/8"	24	1 7/8-12	43,4	50,0	55,0
1216815	-2424	TN	24	38,0	1 1/2"	24	1 7/8-12	43,4	50,0	55,0
1216816	-3232	TN	32	51,0	2"	32	2 1/2-12	49,0	65,0	70,0

// H1222541-M

**45° JIC Female 37° Seat - Medium Drop
DKJ 45M
Solid one piece**

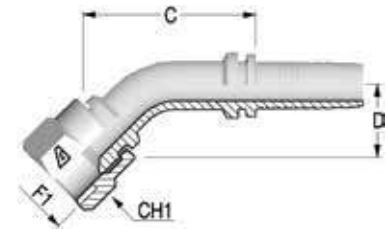

Item Code	Tail/Head	Nut Type	ID			F1		F1	C	D Drop	CH1
	Dash		Dash	mm	in	Dash Size	mm				
1202821	-0304	CR	03	5,0	3/16"	04	7/16-20	37,1	10,0	16,0	
1202822	-0404	CR	04	6,0	1/4"	04	7/16-20	36,6	10,0	16,0	
1202823	-0405	CR	04	6,0	1/4"	05	1/2-20	37,2	12,0	17,0	
1202824	-0406	CR	04	6,0	1/4"	06	9/16-18	39,4	11,0	19,0	
1202825	-0505	CR	05	8,0	5/16"	05	1/2-20	39,8	12,0	17,0	
1202826	-0506	CR	05	8,0	5/16"	06	9/16-18	42,8	12,0	19,0	
1202827	-0606	CR	06	10,0	3/8"	06	9/16-18	46,3	11,0	19,0	
1202791	-0608	CR	06	10,0	3/8"	08	3/4-16	47,2	15,0	25,0	
1202828	-0808	CR	08	13,0	1/2"	08	3/4-16	51,6	15,0	25,0	
1202829	-0810	CR	08	13,0	1/2"	10	7/8-14	50,7	16,0	27,0	
1202830	-0812	CR	08	13,0	1/2"	12	1 1/16-12	57,0	21,0	32,0	
1202832	-1010	CR	10	16,0	5/8"	10	7/8-14	62,2	19,0	27,0	
1202831	-1012	CR	10	16,0	5/8"	12	1 1/16-12	68,6	21,0	32,0	
1202833	-1212	CR	12	19,0	3/4"	12	1 1/16-12	67,5	21,0	32,0	
1200778	-1214	CR	12	19,0	3/4"	14	1 3/16-12	67,6	23,0	36,0	
1202834	-1216	CR	12	19,0	3/4"	16	1 5/16-12	71,4	26,0	38,0	
1202835	-1616	CR	16	25,0	1"	16	1 5/16-12	79,4	24,0	38,0	
1202836	-1620	TN	16	25,0	1"	20	1 5/8-12	83,8	37,0	50,0	
1202837	-2020	TN	20	32,0	1 1/4"	20	1 5/8-12	97,1	37,0	50,0	
1202839	-2424	TN	24	38,0	1 1/2"	24	1 7/8-12	112,7	43,0	55,0	
1202840	-3232	TN	32	51,0	2"	32	2 1/2-12	159,9	67,0	70,0	

Dimensions shown may be changed without prior notice

// H1222591-S

**90° JIC Female 37° Seat - Short Drop
DKJ 90S
Solid one piece**

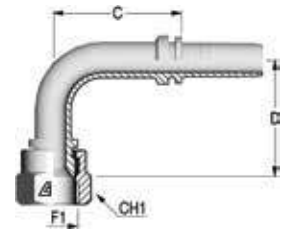

Item Code	Tail/Head	Nut Type	ID			F1		F1	C	D Drop	CH1
	Dash		Dash	mm	in	Dash Size	mm				
1202841	-0304	CR	03	5,0	3/16"	04	7/16-20	26,7	21,0	16,0	
1202772	-0404	CR	04	6,0	1/4"	04	7/16-20	27,0	21,0	16,0	
1203118	-0405	CR	04	6,0	1/4"	05	1/2-20	26,5	23,5	17,0	
1202788	-0406	CR	04	6,0	1/4"	06	9/16-18	31,0	23,0	19,0	
1203116	-0506	CR	05	8,0	5/16"	06	9/16-18	42,7	23,0	19,0	
1216771	-0605	CR	06	10,0	3/8"	05	1/2-20	33,3	25,0	17,0	
1203032	-0606	CR	06	10,0	3/8"	06	9/16-18	42,3	25,0	19,0	
1203033	-0608	CR	06	10,0	3/8"	08	3/4-16	48,8	29,0	25,0	
1216773	-0806	CR	08	13,0	1/2"	06	9/16-18	48,0	23,0	19,0	
1203034	-0808	CR	08	13,0	1/2"	08	3/4-16	46,4	29,0	25,0	
1202815	-0810	CR	08	13,0	1/2"	10	7/8-14	45,8	32,0	27,0	
1202744	-0812	CR	08	13,0	1/2"	12	1 1/16-12	37,3	46,0	32,0	
1203035	-1010	CR	10	16,0	5/8"	10	7/8-14	36,5	32,0	27,0	
1202745	-1012	CR	10	16,0	5/8"	12	1 1/16-12	47,9	48,0	32,0	
1202845	-1212	CR	12	19,0	3/4"	12	1 1/16-12	58,2	46,0	32,0	
1200780	-1214	CR	12	19,0	3/4"	14	1 3/16-12	49,6	52,5	36,0	
1202846	-1216	CR	12	19,0	3/4"	16	1 5/16-12	53,6	53,0	38,0	
1203036	-1616	CR	16	25,0	1"	16	1 5/16-12	74,0	56,0	38,0	

// H1222591-M

**90° JIC Female 37° Seat - Medium Drop
DKJ 90M
Solid one piece**

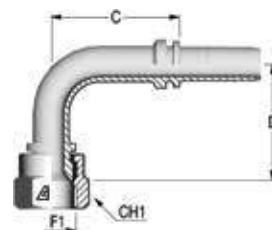

Item Code	Tail/Head	Nut Type	ID			F1		F1	C	D Drop	CH1
	Dash		Dash	mm	in	Dash Size	mm				
1202792	-0304	CR	03	5,0	3/16"	04	7/16-20	33,5	32,0	16,0	
1202739	-0404	CR	04	6,0	1/4"	04	7/16-20	34,2	32,0	16,0	
1202740	-0405	CR	04	6,0	1/4"	05	1/2-20	25,7	30,0	17,0	
1202793	-0406	CR	04	6,0	1/4"	06	9/16-18	28,5	38,0	19,0	
1202794	-0505	CR	05	8,0	5/16"	05	1/2-20	34,2	32,0	17,0	
1202731	-0506	CR	05	8,0	5/16"	06	9/16-18	33,2	35,0	19,0	
1202742	-0606	CR	06	10,0	3/8"	06	9/16-18	31,3	35,0	19,0	
1202732	-0608	CR	06	10,0	3/8"	08	3/4-16	39,5	41,0	25,0	
1200693	-0610	CR	06	10,0	3/8"	10	7/8-14	44,6	47,0	27,0	
1202743	-0808	CR	08	13,0	1/2"	08	3/4-16	37,2	40,0	25,0	
1202741	-0810	CR	08	13,0	1/2"	10	7/8-14	43,3	47,0	27,0	
1202869	-0812	CR	08	13,0	1/2"	12	1 1/16-12	42,8	58,0	32,0	
1202844	-1010	CR	10	16,0	5/8"	10	7/8-14	49,4	48,0	27,0	
1216778	-1012	CR	10	16,0	5/8"	12	1 1/16-12	47,9	58,0	32,0	
1202746	-1212	CR	12	19,0	3/4"	12	1 1/16-12	52,4	54,0	32,0	
1216780	-1216	CR	12	19,0	3/4"	16	1 5/16-12	52,6	72,0	38,0	
1202847	-1616	CR	16	25,0	1"	16	1 5/16-12	72,6	71,5	38,0	
1202848	-1620	TN	16	25,0	1"	20	1 5/8-12	72,6	78,0	50,0	
1202849	-2020	TN	20	32,0	1 1/4"	20	1 5/8-12	82,4	78,0	50,0	
1202850	-2024	TN	20	32,0	1 1/4"	24	1 7/8-12	87,3	82,0	55,0	
1202851	-2424	TN	24	38,0	1 1/2"	24	1 7/8-12	95,3	92,0	55,0	
1202852	-3232	TN	32	51,0	2"	32	2 1/2-12	129,5	140,0	70,0	

// H1222591-L

**90° JIC Female 37° Seat - Long Drop
DKJ 90L
Solid one piece**

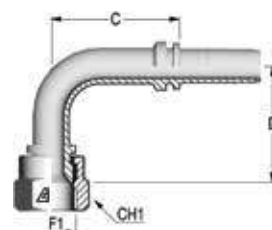

Item Code	Tail/Head	Nut Type	ID			F1		F1	C	D Drop	CH1
	Dash		Dash	mm	in	Dash Size	mm				
1203131	-0404	CR	04	6,0	1/4"	04	7/16-20	30,8	46,0	16,0	
1214215	-0405	CR	04	6,0	1/4"	05	1/2-20	31,3	45,0	17,0	
1202129	-0406	CR	04	6,0	1/4"	06	9/16-18	34,3	54,0	19,0	
1203117	-0506	CR	05	8,0	5/16"	06	9/16-18	36,2	54,0	19,0	
1203115	-0606	CR	06	10,0	3/8"	06	9/16-18	43,3	54,0	19,0	
1202842	-0608	CR	06	10,0	3/8"	08	3/4-16	46,8	64,0	25,0	
1214216	-0808	CR	08	13,0	1/2"	08	3/4-16	49,9	64,0	25,0	
1202843	-0810	CR	08	13,0	1/2"	10	7/8-14	37,3	65,0	27,0	
1203114	-1010	CR	10	16,0	5/8"	10	7/8-14	49,9	65,0	27,0	
1203113	-1012	CR	10	16,0	5/8"	12	1 1/16-12	49,9	96,0	32,0	
1203112	-1212	CR	12	19,0	3/4"	12	1 1/16-12	54,1	95,0	32,0	
1203111	-1616	CR	16	25,0	1"	16	1 5/16-12	78,6	114,0	38,0	

Dimensions shown may be changed without prior notice

// NPTF INSERTS

// H1212810

**NPTF Male 60° Seat
AGN**

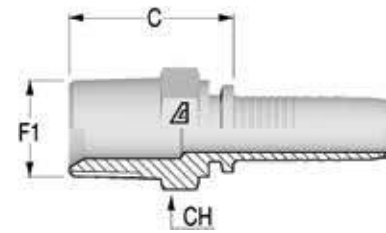

Item Code	Tail/Head	Nut Type	ID			F1		C	CH
	Dash		Dash	mm	in	Dash Size	F1		
1200448	-0302	NA	03	5,0	3/16"	02	1/8-27	20,8	12,0
1200466	-0402	NA	04	6,0	1/4"	02	1/8-27	21,3	14,0
1228235	-0404	NA	04	6,0	1/4"	04	1/4-18	26,8	14,3
1200467	-0406	NA	04	6,0	1/4"	06	3/8-18	27,8	19,0
1203150	-0408	NA	04	6,0	1/4"	08	1/2-14	31,3	22,0
1200511	-0504	NA	05	8,0	5/16"	04	1/4-18	26,8	17,0
1200512	-0506	NA	05	8,0	5/16"	06	3/8-18	27,8	19,0
1200307	-0604	NA	06	10,0	3/8"	04	1/4-18	26,8	17,0
1200308	-0606	NA	06	10,0	3/8"	06	3/8-18	27,8	19,0
1200306	-0608	NA	06	10,0	3/8"	08	1/2-14	31,3	22,0
1200345	-0806	NA	08	13,0	1/2"	06	3/8-18	28,6	19,0
1200343	-0808	NA	08	13,0	1/2"	08	1/2-14	32,1	22,0
1200344	-0812	NA	08	13,0	1/2"	12	3/4-14	34,1	27,0
1200387	-1008	NA	10	16,0	5/8"	08	1/2-14	33,1	24,0
1200388	-1012	NA	10	16,0	5/8"	12	3/4-14	34,1	27,0
1203149	-1208	NA	12	19,0	3/4"	08	1/2-14	33,6	27,0
1200421	-1212	NA	12	19,0	3/4"	12	3/4-14	34,6	27,0
1200420	-1216	NA	12	19,0	3/4"	16	1-11 1/2	43,6	36,0
1216610	-1416	NA	14	22,0	7/8"	16	1-11 1/2	43,6	36,0
1202282	-1612	NA	16	25,0	1"	12	3/4-14	39,4	36,0
1201366	-1616	NA	16	25,0	1"	16	1-11 1/2	44,4	36,0
1201367	-1620	NA	16	25,0	1"	20	1 1/4-11 1/2	47,4	46,0
1216611	-1820	NA	-	29,0	1 1/8"	20	1 1/4-11 1/2	47,4	46,0
1201368	-2020	NA	20	32,0	1 1/4"	20	1 1/4-11 1/2	49,0	46,0
1216612	-2224	NA	-	35,0	1 3/8"	24	1 1/2-11 1/2	50,5	50,0
1201369	-2424	NA	24	38,0	1 1/2"	24	1 1/2-11 1/2	50,5	50,0
1216613	-2932	NA	29	46,0	1 3/4"	32	2-11 1/2	54,2	65,0
1201370	-3232	NA	32	51,0	2"	32	2-11 1/2	54,2	65,0

// H1222810
NPTF Female Solid

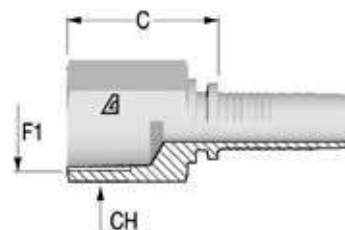

Item Code	Tail/Head	Nut Type	ID			F1	F1	C	CH
	Dash		Dash	mm	in	Dash Size			
1216794	-0402	NA	04	6,0	1/4"	02	1/8-27	22,3	14,0
1200464	-0404	NA	04	6,0	1/4"	04	1/4-18	27,8	19,0
1219145	-0606	NA	06	10,0	3/8"	06	3/8-18	28,8	22,0
1216795	-0808	NA	08	13,0	1/2"	08	1/2-14	35,6	25,0
1216796	-1212	NA	12	19,0	3/4"	12	3/4-14	38,1	32,0
1216797	-1616	NA	16	25,0	1"	16	1-11 1/2	44,9	38,0

// H1212811
NPTF Male Swivel 60° Seat

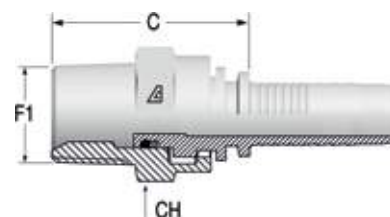

Item Code	Tail/Head	Nut Type	ID			F1	F1	C	CH
	Dash		Dash	mm	in	Dash Size			
1216614	-0404	CR	04	6,0	1/4"	04	1/4-18	37,6	17,0
1216615	-0406	CR	04	6,0	1/4"	06	3/8-18	39,5	22,0
1216616	-0604	CR	06	10,0	3/8"	04	1/4-18	39,6	17,0
1214186	-0606	CR	06	10,0	3/8"	06	3/8-18	37,5	22,0
1216617	-0608	CR	06	10,0	3/8"	08	1/2-14	43,5	25,0
1216619	-0806	CR	08	13,0	1/2"	06	3/8-18	38,3	22,0
1214187	-0808	CR	08	13,0	1/2"	08	1/2-14	42,3	25,0
1216620	-1212	CR	12	19,0	3/4"	12	3/4-14	50,1	32,0
1216621	-1616	CR	16	25,0	1"	16	1-11 1/2	57,9	41,0

// H1212881
90° Compact NPTF Male Swivel 60° Seat

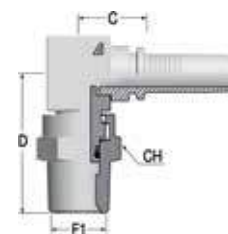

Item Code	Tail/Head	Nut Type	ID			F1	F1	C	D Drop	CH
	Dash		Dash	mm	in	Dash Size				
1225918	-0404	CR	04	6,0	1/4"	04	1/4-18	17,0	39,0	17,0
1225920	-0606	CR	06	10,0	3/8"	06	3/8-18	20,0	41,0	22,0
1225921	-0808	CR	08	13,0	1/2"	08	1/2-14	23,0	48,0	25,0
1225922	-1212	CR	12	19,0	3/4"	12	3/4-14	27,0	61,0	32,0

Dimensions shown may be changed without prior notice

// NPSM INSERTS

// H1227311 NPSM Female

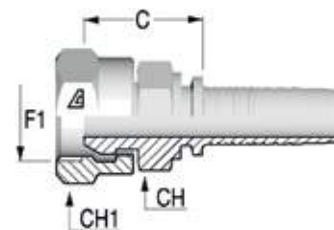

Item Code	Tail/Head Dash	Nut Type	ID			F1		C	CH	CH1
			Dash	mm	in	Dash Size	F1			
1203280	-0404	CR	04	6,0	1/4"	04	1/4-18	24,3	17,0	19,0
1216834	-0606	CR	06	10,0	3/8"	06	3/8-18	24,8	19,0	22,0
1202084	-0808	CR	08	13,0	1/2"	08	1/2-14	26,6	22,0	27,0
1216835	-1212	CR	12	19,0	3/4"	12	3/4-14	28,6	30,0	32,0
1216836	-1616	CR	16	25,0	1"	16	1-11 1/2	35,4	36,0	38,0

// ORFS INSERTS

// H1212410 ORFS Male

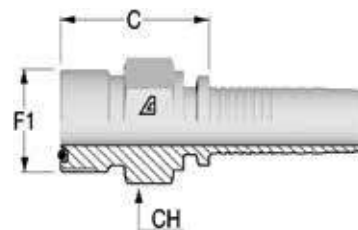

Item Code	Tail/Head	Nut Type	ID			F1	F1	C	CH
	Dash		Dash	mm	in	Dash Size		mm	mm
1202488	-0404	NA	04	6,0	1/4"	04	9/16-18	22,3	17,0
1202489	-0406	NA	04	6,0	1/4"	06	11/16-16	24,3	19,0
1214185	-0506	NA	05	8,0	5/16"	06	11/16-16	24,3	19,0
1202490	-0606	NA	06	10,0	3/8"	06	11/16-16	24,3	19,0
1202491	-0608	NA	06	10,0	3/8"	08	13/16-16	26,3	22,0
1202055	-0610	NA	06	10,0	3/8"	10	1-14	29,8	27,0
1202492	-0808	NA	08	13,0	1/2"	08	13/16-16	27,1	22,0
1202054	-0810	NA	08	13,0	1/2"	10	1-14	30,6	27,0
1202493	-0812	NA	08	13,0	1/2"	12	1 3/16-12	34,1	32,0
1202892	-1010	NA	10	16,0	5/8"	10	1-14	30,6	27,0
1202494	-1012	NA	10	16,0	5/8"	12	1 3/16-12	34,1	32,0
1202495	-1210	NA	12	19,0	3/4"	10	1-14	31,1	27,0
1202496	-1212	NA	12	19,0	3/4"	12	1 3/16-12	34,6	32,0
1202497	-1216	NA	12	19,0	3/4"	16	1 7/16-12	38,1	41,0
1202498	-1616	NA	16	25,0	1"	16	1 7/16-12	37,9	38,0
1202499	-1620	NA	16	25,0	1"	20	1 11/16-12	39,9	46,0
1202500	-2020	NA	20	32,0	1 1/4"	20	1 11/16-12	41,5	46,0

Dimensions shown may be changed without prior notice

// H1222411

ORFS Female with Stem Hexagon

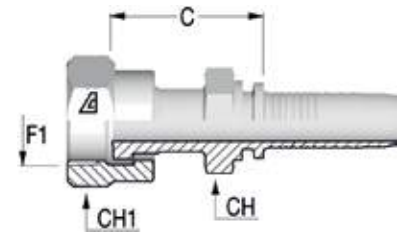

Item Code	Tail/Head	Nut Type	ID			F1		F1	C	CH	CH1
	Dash		Dash	mm	in	Dash Size	mm				
1203220	-0304	CR	03	5,0	3/16"	04	9/16-18	26,8	14,0	17,0	
1201586	-0404	CR	04	6,0	1/4"	04	9/16-18	27,3	14,0	17,0	
1201855	-0406	CR	04	6,0	1/4"	06	11/16-16	30,3	17,0	22,0	
1203143	-0408	CR	04	6,0	1/4"	08	13/16-16	35,3	22,0	24,0	
1201741	-0506	CR	05	8,0	5/16"	06	11/16-16	30,3	17,0	22,0	
1203237	-0604	CR	06	10,0	3/8"	04	9/16-18	28,3	17,0	17,0	
1202369	-0606	CR	06	10,0	3/8"	06	11/16-16	30,3	17,0	22,0	
1201339	-0608	CR	06	10,0	3/8"	08	13/16-16	35,3	22,0	24,0	
1202563	-0806	CR	08	13,0	1/2"	06	11/16-16	32,1	19,0	22,0	
1201338	-0808	CR	08	13,0	1/2"	08	13/16-16	36,1	22,0	24,0	
1202052	-0810	CR	08	13,0	1/2"	10	1-14	39,6	24,0	30,0	
1203053	-0812	CR	08	13,0	1/2"	12	1 3/16-12	42,1	30,0	36,0	
1203061	-1008	CR	10	16,0	5/8"	08	13/16-16	37,1	24,0	24,0	
1202612	-1010	CR	10	16,0	5/8"	10	1-14	39,6	24,0	30,0	
1201815	-1012	CR	10	16,0	5/8"	12	1 3/16-12	42,1	30,0	36,0	
1201782	-1210	CR	12	19,0	3/4"	10	1-14	40,1	27,0	30,0	
1202560	-1212	CR	12	19,0	3/4"	12	1 3/16-12	42,6	30,0	36,0	
1202053	-1216	CR	12	19,0	3/4"	16	1 7/16-12	48,6	36,0	41,0	
1216717	-1416	CR	14	22,0	7/8"	16	1 7/16-12	48,6	36,0	41,0	
1203142	-1612	CR	16	25,0	1"	12	1 3/16-12	45,4	32,0	36,0	
1201446	-1616	CR	16	25,0	1"	16	1 7/16-12	49,4	36,0	41,0	
1203056	-1620	CR	16	25,0	1"	20	1 11/16-12	50,4	41,0	50,0	
1201447	-2020	CR	20	32,0	1 1/4"	20	1 11/16-12	52,0	41,0	50,0	
1226017	-2024	CR	20	32,0	1 1/4"	24	2-12	56,5	50,0	60,0	
1202046	-2424	CR	24	38,0	1 1/2"	24	2-12	56,5	50,0	60,0	

// H1222443-M

45° ORFS Female - Medium Drop
DK ORFS 45M
Solid one piece

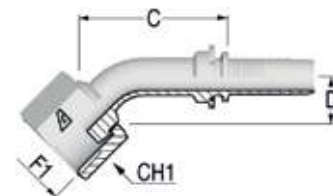

Item Code	Tail/Head	Nut Type	ID			F1	F1	C	D Drop	CH1
	Dash		Dash	mm	in	Dash Size				
1202774	-0404	SN	04	6,0	1/4"	04	9/16-18	41,1	11,0	17,0
1202775	-0406	SN	04	6,0	1/4"	06	11/16-16	46,1	11,0	22,0
1202871	-0506	SN	05	8,0	5/16"	06	11/16-16	46,3	12,0	22,0
1202776	-0606	SN	06	10,0	3/8"	06	11/16-16	47,4	12,0	22,0
1202777	-0608	SN	06	10,0	3/8"	08	13/16-16	51,2	15,0	24,0
1202854	-0808	CR	08	13,0	1/2"	08	13/16-16	47,1	16,0	24,0
1202771	-0810	SN	08	13,0	1/2"	10	1-14	50,4	16,5	30,0
1202819	-1010	SN	10	16,0	5/8"	10	1-14	57,7	17,0	30,0
1202853	-1012	SN	10	16,0	5/8"	12	1 3/16-12	63,1	21,0	36,0
1203060	-1210	CR	12	19,0	3/4"	10	1-14	51,4	24,0	30,0
1202872	-1212	SN	12	19,0	3/4"	12	1 3/16-12	63,5	21,0	36,0
1202915	-1216	SN	12	19,0	3/4"	16	1 7/16-12	70,7	24,0	41,0
1202797	-1616	SN	16	25,0	1"	16	1 7/16-12	82,4	26,0	41,0
1203141	-1620	SN	16	25,0	1"	20	1 11/16-12	85,4	26,0	50,0
1202873	-2020	SN	20	32,0	1 1/4"	20	1 11/16-12	97,4	26,0	50,0
1203140	-2024	SN	20	32,0	1 1/4"	24	2-12	101,1	28,0	60,0
1202874	-2424	SN	24	38,0	1 1/2"	24	2-12	104,4	28,0	60,0

// H1222493-S

90° ORFS Female - Short Drop
DK ORFS 90S
Solid one piece

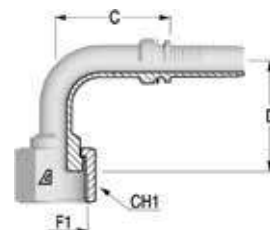

Item Code	Tail/Head	Nut Type	ID			F1	F1	C	D Drop	CH1
	Dash		Dash	mm	in	Dash Size				
1202778	-0404	SN	04	6,0	1/4"	04	9/16-18	28,5	21,0	17,0
1202856	-0406	SN	04	6,0	1/4"	06	11/16-16	32,0	23,0	22,0
1202857	-0506	SN	05	8,0	5/16"	06	11/16-16	49,3	23,0	22,0
1202858	-0606	SN	06	10,0	3/8"	06	11/16-16	41,8	25,0	22,0
1202859	-0608	SN	06	10,0	3/8"	08	13/16-16	41,8	29,0	24,0
1203392	-0806	CR	08	13,0	1/2"	06	11/16-16	44,1	25,0	22,0
1202855	-0808	CR	08	13,0	1/2"	08	13/16-16	39,8	29,0	24,0
1203054	-0810	SN	08	13,0	1/2"	10	1-14	46,3	32,5	30,0
1203334	-0812	SN	08	13,0	1/2"	12	1 3/16-12	56,3	51,0	36,0
1202860	-1010	SN	10	16,0	5/8"	10	1-14	52,3	32,5	30,0
1202861	-1012	SN	10	16,0	5/8"	12	1 3/16-12	55,4	49,0	36,0
1202862	-1212	SN	12	19,0	3/4"	12	1 3/16-12	60,6	51,0	36,0
1203055	-1216	SN	12	19,0	3/4"	16	1 7/16-12	61,6	56,0	41,0
1203209	-1612	CR	16	25,0	1"	12	1 3/16-12	54,6	51,0	36,0
1202863	-1616	SN	16	25,0	1"	16	1 7/16-12	80,0	58,0	41,0
1203135	-1620	SN	16	25,0	1"	20	1 11/16-12	82,6	64,0	50,0
1203133	-2020	SN	20	32,0	1 1/4"	20	1 11/16-12	95,0	68,0	50,0
1214211	-2024	SN	20	32,0	1 1/4"	24	2-12	102,0	69,0	60,0
1214213	-2424	SN	24	38,0	1 1/2"	24	2-12	103,7	78,0	60,0

Dimensions shown may be changed without prior notice

// H1222493-M

90° ORFS Female - Medium Drop
DK ORFS 90M
Solid one piece

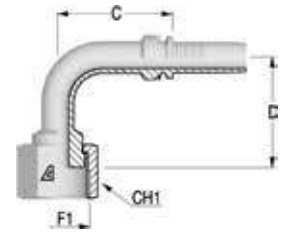

Item Code	Tail/Head	Nut Type	ID			F1	F1	C	D Drop	CH1
	Dash		Dash	mm	in	Dash Size				
1202875	-0404	SN	04	6,0	1/4"	04	9/16-18	29,8	32,0	17,0
1202715	-0406	SN	04	6,0	1/4"	06	11/16-16	37,3	38,0	22,0
1202779	-0506	SN	05	8,0	5/16"	06	11/16-16	40,7	34,0	22,0
1202780	-0606	SN	06	10,0	3/8"	06	11/16-16	41,8	38,0	22,0
1202716	-0608	SN	06	10,0	3/8"	08	13/16-16	43,8	41,0	24,0
1202781	-0808	CR	08	13,0	1/2"	08	13/16-16	34,8	42,0	24,0
1202770	-0810	SN	08	13,0	1/2"	10	1-14	48,3	47,0	30,0
1202782	-1010	SN	10	16,0	5/8"	10	1-14	55,4	44,0	30,0
1203137	-1012	SN	10	16,0	5/8"	12	1 3/16-12	55,4	58,0	36,0
1202783	-1212	SN	12	19,0	3/4"	12	1 3/16-12	61,6	58,0	36,0
1202916	-1216	SN	12	19,0	3/4"	16	1 7/16-12	65,6	71,0	41,0
1216748	-1612	CR	16	25,0	1"	12	1 3/16-12	62,6	58,0	36,0
1202717	-1616	SN	16	25,0	1"	16	1 7/16-12	82,6	66,0	41,0
1203069	-1620	SN	16	25,0	1"	20	1 11/16-12	82,6	78,0	50,0
1202876	-2020	SN	20	32,0	1 1/4"	20	1 11/16-12	97,0	78,0	50,0
1203132	-2024	SN	20	32,0	1 1/4"	24	2-12	102,0	84,0	60,0
1202877	-2424	SN	24	38,0	1 1/2"	24	2-12	107,8	87,0	60,0

// H1222493-L

90° ORFS Female - Long Drop
DK ORFS 90L
Solid one piece

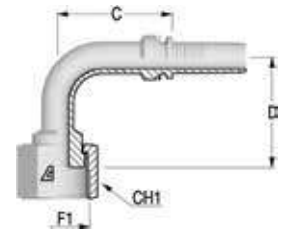

Item Code	Tail/Head	Nut Type	ID			F1	F1	C	D Drop	CH1
	Dash		Dash	mm	in	Dash Size				
1210841	-0404	SN	04	6,0	1/4"	04	9/16-18	32,8	46,0	17,0
1203139	-0406	SN	04	6,0	1/4"	06	11/16-16	34,8	54,0	22,0
1203138	-0606	SN	06	10,0	3/8"	06	11/16-16	41,8	54,0	22,0
1203057	-0608	SN	06	10,0	3/8"	08	13/16-16	46,8	64,0	24,0
1202922	-0808	CR	08	13,0	1/2"	08	13/16-16	38,3	64,0	24,0
1214208	-0810	SN	08	13,0	1/2"	10	1-14	46,3	70,0	30,0
1202918	-1010	SN	10	16,0	5/8"	10	1-14	55,4	70,0	30,0
1202919	-1012	SN	10	16,0	5/8"	12	1 3/16-12	55,4	96,0	36,0
1202920	-1212	SN	12	19,0	3/4"	12	1 3/16-12	61,6	96,0	36,0
1202921	-1216	SN	12	19,0	3/4"	16	1 7/16-12	61,6	118,0	41,0
1203136	-1616	SN	16	25,0	1"	16	1 7/16-12	82,6	114,0	41,0
1203134	-2020	SN	20	32,0	1 1/4"	20	1 11/16-12	97,0	129,0	50,0
1214210	-2024	SN	20	32,0	1 1/4"	24	2-12	102,0	141,0	60,0
1214212	-2424	SN	24	38,0	1 1/2"	24	2-12	110,8	141,0	60,0

// FRENCH INSERTS

// H1211810

**Metric Male
French Type**

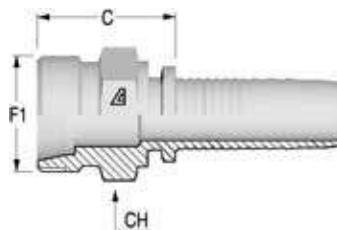

Item Code	Tail/Head Dash/mm	Nut Type	ID			F1	OD1 mm	C mm	CH mm
			Dash	mm	in				
1200522	-0520	NA	05	8,0	5/16"	M20X1.5	13,25	17,0	22,0
1200317	-0620	NA	06	10,0	3/8"	M20X1.5	13,25	25,3	22,0
1200361	-0824	NA	08	13,0	1/2"	M24X1.5	16,75	27,1	24,0
1200404	-1030	NA	10	16,0	5/8"	M30X1.5	21,25	31,1	30,0
1200435	-1236	NA	12	19,0	3/4"	M36X1.5	26,75	33,6	36,0

// H1221813

**Metric Female
French Type**

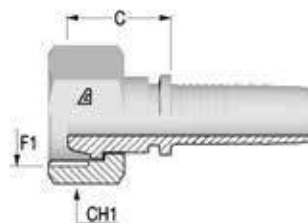

Item Code	Tail/Head Dash/mm	Nut Type	ID			F1	OD1 mm	C mm	CH1 mm
			Dash	mm	in				
1200651	-0520	SN	05	8,0	5/16"	M20X1.5	14	23,8	24,0
1200681	-0620	SN	06	10,0	3/8"	M20X1.5	14	23,8	24,0
1200717	-0824	SN	08	13,0	1/2"	M24X1.5	16	26,8	30,0
1200744	-1030	SN	10	16,0	5/8"	M30X1.5	22	26,6	36,0
1200770	-1236	SN	12	19,0	3/4"	M36X1.5	28	27,0	42,0

// H1221893

**90° Metric Female
French type**

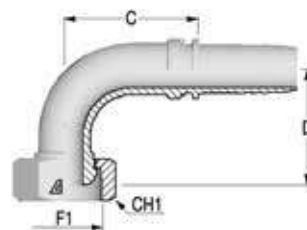

Item Code	Tail/Head Dash/mm	Nut Type	ID			F1	OD1 mm	C mm	D Drop mm	CH1 mm
			Dash	mm	in					
1200654	-0520	SN	05	8,0	5/16"	M20X1.5	14	32,5	36,5	24,0
1200683	-0620	SN	06	10,0	3/8"	M20X1.5	14	36,7	44,0	24,0
1200719	-0824	SN	08	13,0	1/2"	M24X1.5	16	39,5	46,0	30,0
1203156	-1030	SN	10	16,0	5/8"	M30X1.5	22	43,0	49,0	36,0
1200773	-1236	SN	12	19,0	3/4"	M36X1.5	28	46,6	48,5	42,0

Dimensions shown may be changed without prior notice

// JIS INSERTS

// H1223711

JIS Female 60° Cone - B 8363 (type C)

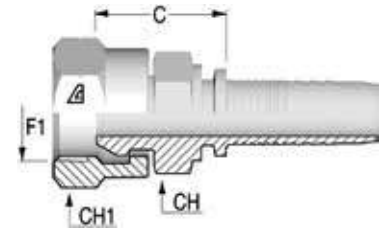

Item Code	Tail/Head Dash	Nut Type	ID			F1		F1	C	CH	CH1
			Dash	mm	in	Dash Size	F1				
1203110	-0404	CR	04	6,0	1/4"	04	1/4-19	24,3	17,0	19,0	
1226067	-0406	CR	04	6,0	1/4"	06	3/8-19	25,5	19,0	22,0	
1203109	-0606	CR	06	10,0	3/8"	06	3/8-19	25,5	19,0	22,0	
1226068	-0608	CR	06	10,0	3/8"	08	1/2-14	25,3	22,0	27,0	
1203108	-0808	CR	08	13,0	1/2"	08	1/2-14	26,1	22,0	27,0	
1226069	-1008	CR	10	16,0	5/8"	08	1/2-14	27,1	24,0	27,0	
1226549	-1012	CR	10	16,0	5/8"	12	3/4-14	29,6	30,0	36,0	
1203107	-1212	CR	12	19,0	3/4"	12	3/4-14	30,1	30,0	36,0	
1214218	-1616	CR	16	25,0	1"	16	1-11	34,9	36,0	41,0	

// H1223741

45° JIS Female 60° Cone - B 8363 (type C)

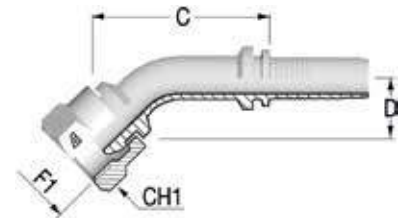

Item Code	Tail/Head Dash	Nut Type	ID			F1		C	D Drop	CH1
			Dash	mm	in	Dash Size	F1			
1216798	-0404	CR	04	6,0	1/4"	04	1/4-19	24,3	19,0	19,0
1216799	-0606	CR	06	10,0	3/8"	06	3/8-19	26,5	21,0	22,0
1216800	-0808	CR	08	13,0	1/2"	08	1/2-14	27,0	22,0	27,0
1216801	-1212	CR	12	19,0	3/4"	12	3/4-14	19,9	25,0	36,0

// H1223791

90° JIS Female 60° Cone - B 8363 (type C)

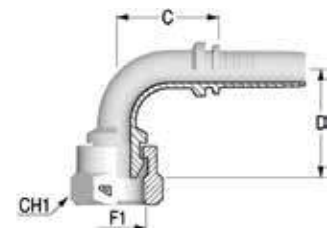

Item Code	Tail/Head Dash	Nut Type	ID			F1		C	D Drop	CH1
			Dash	mm	in	Dash Size	F1			
1216803	-0404	CR	04	6,0	1/4"	04	1/4-19	25,3	33,0	19,0
1216805	-0606	CR	06	10,0	3/8"	06	3/8-19	32,3	36,5	22,0
1216806	-0808	CR	08	13,0	1/2"	08	1/2-14	37,3	38,5	27,0
1216807	-1212	CR	12	19,0	3/4"	12	3/4-14	51,6	52,0	36,0

// H122381Z

JIS Female 60° Seat Flare - B 8363 (type F)

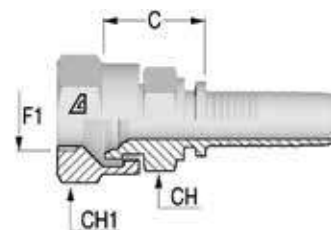

Item Code	Tail/Head	Nut Type	ID			F1	F1	C	CH	CH1
	Dash		Dash	mm	in	Dash Size				
1202947	-0404	CR	04	6,0	1/4"	04	1/4-19	20,8	17,0	19,0
1202879	-0606	CR	06	10,0	3/8"	06	3/8-19	21,8	19,0	22,0
1202878	-0808	CR	08	13,0	1/2"	08	1/2-14	23,6	22,0	27,0
1203106	-1212	CR	12	19,0	3/4"	12	3/4-14	27,1	30,0	36,0
1203105	-1616	CR	16	25,0	1"	16	1-11	32,9	36,0	41,0
1201585	-2020	TN	20	32,0	1 1/4"	20	1 1/4-11	39,5	46,0	50,0
1201677	-2424	TN	24	38,0	1 1/2"	24	1 1/2-11	41,5	50,0	55,0

// H122384Z

45° JIS Female 60° Seat Flare - B 8363 (type F)

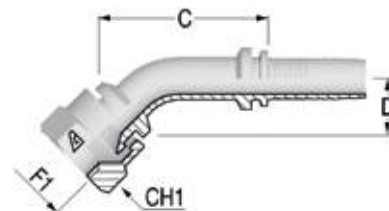

Item Code	Tail/Head	Nut Type	ID			F1	F1	C	D Drop	CH1
	Dash		Dash	mm	in	Dash Size				
1203104	-0404	CR	04	6,0	1/4"	04	1/4-19	42,5	15,0	19,0
1203103	-0606	CR	06	10,0	3/8"	06	3/8-19	50,6	16,5	22,0
1203101	-1212	CR	12	19,0	3/4"	12	3/4-14	72,5	22,0	36,0
1203100	-1616	CR	16	25,0	1"	16	1-11	82,0	29,0	41,0

// H122389Z

90° JIS Female 60° Seat Flare - B 8363 (type F)

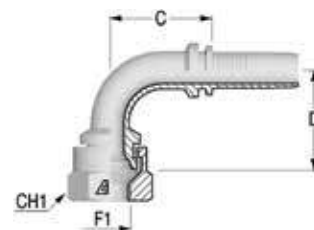

Item Code	Tail/Head	Nut Type	ID			F1	F1	C	D Drop	CH1
	Dash		Dash	mm	in	Dash Size				
1203095	-0404	CR	04	6,0	1/4"	04	1/4-19	27,3	29,5	19,0
1203094	-0606	CR	06	10,0	3/8"	06	3/8-19	31,3	33,0	22,0
1203093	-0808	CR	08	13,0	1/2"	08	1/2-14	37,3	36,5	27,0
1203092	-1212	CR	12	19,0	3/4"	12	3/4-14	46,1	52,0	36,0
1203091	-1616	CR	16	25,0	1"	16	1-11	77,1	64,5	41,0

Dimensions shown may be changed without prior notice

// KOMATSU INSERTS

// H1224011

Komatsu Female

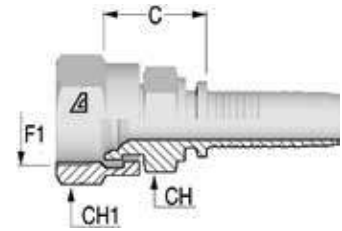

Item Code	Tail/Head	Nut Type	ID		F1		F1	C	CH	CH1
	Dash		Dash	mm	in	Dash Size				
1200502	-0414	CR	04	6,0	1/4"	14	M14X1.5	20,8	17,0	19,0
1216808	-0614	CR	06	10,0	3/8"	14	M14X1.5	20,8	17,0	19,0
1200334	-0618	CR	06	10,0	3/8"	18	M18X1.5	21,8	19,0	22,0
1202688	-0822	CR	08	13,0	1/2"	22	M22X1.5	23,6	22,0	27,0
1200414	-1024	CR	10	16,0	5/8"	24	M24X1.5	27,1	30,0	32,0
1200444	-1230	CR	12	19,0	3/4"	30	M30X1.5	27,6	30,0	36,0
1201720	-1633	CR	16	25,0	1"	33	M33X1.5	35,7	36,0	41,0
1202032	-2442	CR	24	38,0	1 1/2"	42	M42X1.5	44,0	55,0	55,0

// H1244110

Komatsu Flange

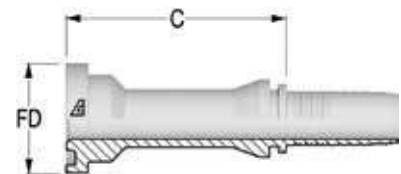

Item Code	Tale/Head	Dash	ID		Flange		C	FD
	Dash		mm	in	Dash Size	Flange Size		
1201625	-1010	10	16,0	5/8"	10	5/8	46,7	34,0

// H1244140

**45° Komatsu Flange
Solid one piece**

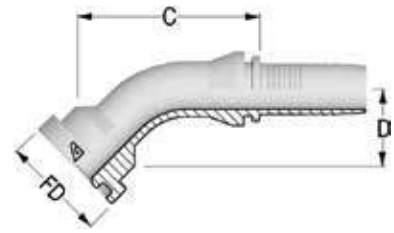

Item Code	Tale/Head	ID			Flange	Flange Size	FD	C	D Drop
	Dash	Dash	mm	in	Dash Size		mm	mm	mm
1202066	-1010	10	16,0	5/8"	10	5/8	34,0	49,1	25,0

// H1244190

**90° Komatsu Flange
Solid one piece**

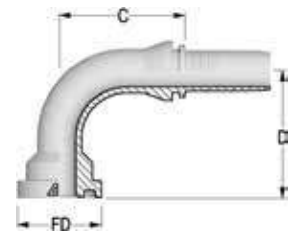

Item Code	Tale/Head	ID			Flange	Flange Size	FD	C	D Drop
	Dash	Dash	mm	in	Dash Size		mm	mm	mm
1202067	-1010	10	16,0	5/8"	10	5/8	34,0	51,0	51,0

Dimensions shown may be changed without prior notice

// SAE FLANGES

// H1243310

Flange SAE 3000 PSI J518 Code 61 - SFL

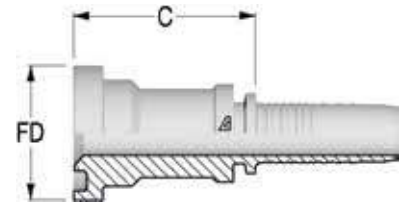

Item Code	Tail/Head	ID		Flange		C	FD	WP	
	Dash	Dash	mm	in	Dash Size				Flange Size
1202747	-0808	08	13,0	1/2"	08	1/2	41,0	30,2	5000
1202763	-0812	08	13,0	1/2"	12	3/4	42,0	38,1	5000
1202801	-1012	10	16,0	5/8"	12	3/4	42,2	38,1	5000
1201734	-1212	12	19,0	3/4"	12	3/4	42,5	38,1	5000
1202750	-1216	12	19,0	3/4"	16	1	50,5	44,5	5000
1201408	-1616	16	25,0	1"	16	1	51,4	44,5	5000
1201409	-1620	16	25,0	1"	20	1 1/4	53,9	50,8	4000
1216849	-1624	16	25,0	1"	24	1 1/2	56,9	60,3	3000
1221654	-2016	20	32,0	1 1/4"	16	1	53,0	44,5	5000
1201410	-2020	20	32,0	1 1/4"	20	1 1/4	55,5	50,8	4000
1201411	-2024	20	32,0	1 1/4"	24	1 1/2	58,5	60,3	3000
1201412	-2424	24	38,0	1 1/2"	24	1 1/2	58,5	60,3	3000
1201413	-2432	24	38,0	1 1/2"	32	2	70,0	71,4	3000
1221662	-3224	32	51,0	2"	24	1 1/2	66,0	60,3	3000
1201414	-3232	32	51,0	2"	32	2	70,0	71,4	3000
1202074	-3240	32	51,0	2"	40	2 1/2	83,0	81,1	2500
1226113	-4032	40	63,0	2 1/2"	32	2	86,5	71,4	3000
1203063	-4040	40	63,0	2 1/2"	40	2 1/2	86,5	84,1	2500

// H1243320

22° Flange SAE 3000 PSI J518 Code 61 - SFL 22
Solid one piece

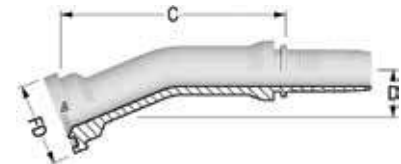

Item Code	Tail/Head	ID		Flange		FD	C	D Drop	WP	
	Dash	Dash	mm	in	Dash Size					Flange Size
1216854	-1616	16	25,0	1"	16	1	44,5	92,7	12,0	5000
1216856	-2020	20	32,0	1 1/4"	20	1 1/4	50,8	113,6	16,0	4000
1216857	-2024	20	32,0	1 1/4"	24	1 1/2	60,3	114,7	20,5	3000
1216858	-2424	24	38,0	1 1/2"	24	1 1/2	60,3	131,0	22,0	3000
1216859	-3232	32	51,0	2"	32	2	71,4	153,0	30,0	3000

// H1243330

30° Flange SAE 3000 PSI J518 Code 61 - SFL 30
Solid one piece

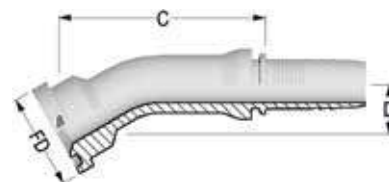

Item Code	Tail/Head	ID		Flange		Flange Size	FD	C	D Drop	WP
	Dash	Dash	mm	in	Dash Size					
1216861	-1212	12	19,0	3/4"	12	3/4	38,1	80,8	12,0	5000
1216862	-1216	12	19,0	3/4"	16	1	44,5	83,8	12,0	5000
1216863	-1616	16	25,0	1"	16	1	44,5	89,8	12,0	5000
1216864	-1620	16	25,0	1"	20	1 1/4	50,8	90,0	12,0	4000
1216865	-1624	16	25,0	1"	24	1 1/2	60,3	104,8	12,0	3000
1216866	-2020	20	32,0	1 1/4"	20	1 1/4	50,8	102,4	12,0	4000
1216867	-2024	20	32,0	1 1/4"	24	1 1/2	60,3	111,9	13,0	3000
1216868	-2424	24	38,0	1 1/2"	24	1 1/2	60,3	128,6	23,0	3000
1216869	-2432	24	38,0	1 1/2"	32	2	71,4	147,0	29,5	3000

// H1243340

45° Flange SAE 3000 PSI J518 Code 61 - SFL 45
Solid one piece

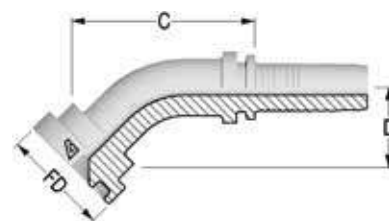

Item Code	Tail/Head	ID		Flange		Flange Size	FD	C	D Drop	WP
	Dash	Dash	mm	in	Dash Size					
1202748	-0808	08	13,0	1/2"	08	1/2	30,2	52,9	22,0	5000
1202751	-0812	08	13,0	1/2"	12	3/4	38,1	60,3	26,0	5000
1202804	-1012	10	16,0	5/8"	12	3/4	38,1	65,0	26,0	5000
1202678	-1212	12	19,0	3/4"	12	3/4	38,1	73,7	32,0	5000
1202752	-1216	12	19,0	3/4"	16	1	44,5	77,9	29,0	5000
1214223	-1220	12	19,0	3/4"	20	1 1/4	50,8	81,5	30,0	5000
1202681	-1616	16	25,0	1"	16	1	44,5	82,7	33,5	5000
1201845	-1620	16	25,0	1"	20	1 1/4	50,8	82,2	36,0	4000
1216872	-2016	20	32,0	1 1/4"	16	1	44,5	114,6	35,1	5000
1201848	-2020	20	32,0	1 1/4"	20	1 1/4	50,8	95,1	37,5	4000
1202677	-2024	20	32,0	1 1/4"	24	1 1/2	60,3	104,1	40,0	3000
1216873	-2420	24	38,0	1 1/2"	20	1 1/4	50,8	144,9	49,5	4000
1202753	-2424	24	38,0	1 1/2"	24	1 1/2	60,3	116,7	48,0	3000
1202754	-2432	24	38,0	1 1/2"	32	2	71,4	135,6	55,5	3000
1201982	-3232	32	51,0	2"	32	2	71,4	140,8	47,5	3000
1216874	-4040	40	63,0	2 1/2"	40	2 1/2	84,1	139,0	53,0	2500

Dimensions shown may be changed without prior notice

// H1243360

60° Flange SAE 3000 PSI J518 Code 61 - SFL 60
Solid one piece

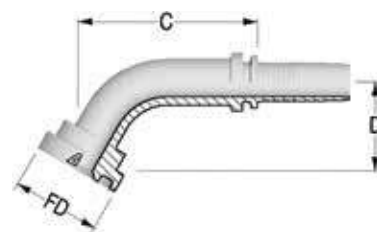

Item Code	Tail/Head		ID		Flange		FD	C	D Drop	WP
	Dash	Dash	mm	in	Dash Size	Flange Size				
1216877	-0808	08	13,0	1/2"	08	1/2	30,2	62,8	30,0	5000
1216878	-1212	12	19,0	3/4"	12	3/4	38,1	85,7	37,0	5000
1216879	-1216	12	19,0	3/4"	16	1	44,5	102,0	44,0	5000
1216880	-1616	16	25,0	1"	16	1	44,5	101,0	47,0	5000
1216881	-1620	16	25,0	1"	20	1 1/4	50,8	106,6	43,5	4000
1216882	-2020	20	32,0	1 1/4"	20	1 1/4	50,8	129,5	56,5	4000
1202882	-2424	24	38,0	1 1/2"	24	1 1/2	60,3	151,5	57,0	3000
1226573	-2432	24	38,0	1 1/2"	32	2	71,4	165,5	77,5	3000
1216884	-3232	32	51,0	2"	32	2	71,4	173,0	92,0	3000

// H1243390

90° Flange SAE 3000 PSI J518 Code 61 - SFL 90
Solid one piece

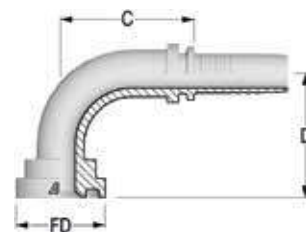

Item Code	Tail/Head		ID		Flange		FD	C	D Drop	WP
	Dash	Dash	mm	in	Dash Size	Flange Size				
1202749	-0808	08	13,0	1/2"	08	1/2	30,2	45,8	42,0	5000
1202755	-0812	08	13,0	1/2"	12	3/4	38,1	45,3	51,0	5000
1216886	-0816	08	13,0	1/2"	16	1	44,5	59,9	63,0	5000
1202805	-1012	10	16,0	5/8"	12	3/4	38,1	49,4	51,0	5000
1202679	-1212	12	19,0	3/4"	12	3/4	38,1	59,7	58,0	5000
1202756	-1216	12	19,0	3/4"	16	1	44,5	66,2	64,5	5000
1202883	-1220	12	19,0	3/4"	20	1 1/4	50,8	69,7	60,0	4000
1202680	-1616	16	25,0	1"	16	1	44,5	70,6	67,0	5000
1201846	-1620	16	25,0	1"	20	1 1/4	50,8	73,6	71,0	4000
1216894	-1624	16	25,0	1"	24	1 1/2	60,3	93,1	75,0	3000
1202884	-2016	20	32,0	1 1/4"	16	1	44,5	94,4	65,0	5000
1201847	-2020	20	32,0	1 1/4"	20	1 1/4	50,8	88,0	84,0	4000
1202676	-2024	20	32,0	1 1/4"	24	1 1/2	60,3	91,5	87,5	3000
1202806	-2420	24	38,0	1 1/2"	20	1 1/4	50,8	93,6	93,0	4000
1202757	-2424	24	38,0	1 1/2"	24	1 1/2	60,3	104,8	91,0	3000
1202758	-2432	24	38,0	1 1/2"	32	2	71,4	104,8	115,0	3000
1216898	-3224	32	51,0	2"	24	1 1/2	60,3	132,8	133,0	3000
1201983	-3232	32	51,0	2"	32	2	71,4	129,3	130,0	3000
1203169	-3240	32	51,0	2"	40	2 1/2	84,1	103,0	100,0	2500
1216900	-4032	40	63,0	2 1/2"	32	2	71,4	106,2	160,0	3000
1203364	-4040	40	63,0	2 1/2"	40	2 1/2	84,1	137,2	125,0	2500

// H1243610

Flange SAE 6000 PSI J518 Code 62 - SFS

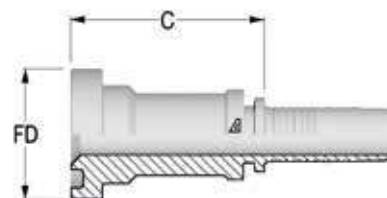

Item Code	Tail/Head	ID		Flange		C	FD	WP	
	Dash	Dash	mm	in	Dash Size				Flange Size
1202511	-0808	08	13,0	1/2"	08	1/2	47,0	31,8	6000
1202759	-0812	08	13,0	1/2"	12	3/4	52,0	41,3	6000
1202807	-1012	10	16,0	5/8"	12	3/4	52,2	41,3	6000
1226137	-1016	10	16,0	5/8"	16	1	55,7	47,6	6000
1202733	-1212	12	19,0	3/4"	12	3/4	52,5	41,3	6000
1202760	-1216	12	19,0	3/4"	16	1	55,5	47,6	6000
1216908	-1612	16	25,0	1"	12	3/4	56,4	41,3	6000
1201415	-1616	16	25,0	1"	16	1	56,4	47,6	6000
1201416	-1620	16	25,0	1"	20	1 1/4	63,4	54,0	6000
1201417	-2020	20	32,0	1 1/4"	20	1 1/4	83,0	54,0	6000
1201418	-2024	20	32,0	1 1/4"	24	1 1/2	71,0	63,5	6000
1216909	-2420	24	38,0	1 1/2"	20	1 1/4	95,0	54,0	6000
1201419	-2424	24	38,0	1 1/2"	24	1 1/2	101,0	63,5	6000
1201420	-2432	24	38,0	1 1/2"	32	2	76,0	79,4	6000
1201421	-3232	32	51,0	2"	32	2	76,0	79,4	6000

// H1243640

**45° Flange SAE 6000 PSI J518 Code 62 - SFS 45
Solid one piece**



Item Code	Tail/Head	ID		Flange		FD	C	D Drop	WP	
	Dash	Dash	mm	in	Dash Size					Flange Size
1201729	-0808	08	13,0	1/2"	08	1/2	31,8	56,5	23,0	6000
1202764	-0812	08	13,0	1/2"	12	3/4	41,3	79,9	30,5	6000
1216910	-1012	10	16,0	5/8"	12	3/4	41,3	69,0	31,0	6000
1202082	-1212	12	19,0	3/4"	12	3/4	41,3	84,1	31,0	6000
1202083	-1216	12	19,0	3/4"	16	1	47,6	80,0	33,5	6000
1201794	-1616	16	25,0	1"	16	1	47,6	96,7	36,0	6000
1202091	-1620	16	25,0	1"	20	1 1/4	54,0	96,1	39,0	6000
1216911	-2016	20	32,0	1 1/4"	16	1	47,6	114,0	35,0	6000
1202761	-2020	20	32,0	1 1/4"	20	1 1/4	54,0	108,6	40,0	6000
1202452	-2024	20	32,0	1 1/4"	24	1 1/2	63,5	114,8	45,5	6000
1202453	-2424	24	38,0	1 1/2"	24	1 1/2	63,5	122,9	45,0	6000
1202765	-2432	24	38,0	1 1/2"	32	2	79,4	133,3	57,5	6000
1202734	-3232	32	51,0	2"	32	2	79,4	156,6	60,0	6000

Dimensions shown may be changed without prior notice

// H1243690

90° Flange SAE 6000 PSI J518 Code 62 - SFS 90
Solid one piece

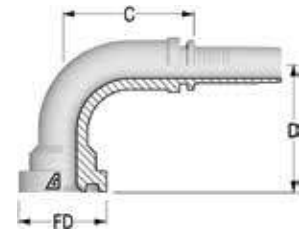

Item Code	Tail/Head	ID		Flange		Flange Size	FD	C	D Drop	WP
	Dash	Dash	mm	in	Dash Size					
1202257	-0808	08	13,0	1/2"	08	1/2	31,8	47,8	46,0	6000
1202766	-0812	08	13,0	1/2"	12	3/4	41,3	47,8	54,0	6000
1242230	-1008	10	16,0	5/8"	08	1/2	31,8	50,0	52,0	6000
1202808	-1008	10	16,0	5/8"	08	1/2	31,8	50,0	52,0	6000
1202814	-1012	10	16,0	5/8"	12	3/4	41,3	49,9	55,0	6000
1202075	-1212	12	19,0	3/4"	12	3/4	41,3	63,2	61,0	6000
1201795	-1216	12	19,0	3/4"	16	1	47,6	63,2	66,0	6000
1216913	-1612	16	25,0	1"	12	3/4	41,3	72,6	61,0	6000
1201739	-1616	16	25,0	1"	16	1	47,6	73,6	75,0	6000
1202767	-1620	16	25,0	1"	20	1 1/4	54,0	77,6	78,0	6000
1202735	-2020	20	32,0	1 1/4"	20	1 1/4	54,0	94,5	89,0	6000
1202768	-2024	20	32,0	1 1/4"	24	1 1/2	63,5	98,0	94,0	6000
1202736	-2424	24	38,0	1 1/2"	24	1 1/2	63,5	99,6	105,0	6000
1202769	-2432	24	38,0	1 1/2"	32	2	79,4	116,9	123,0	6000
1202762	-3232	32	51,0	2"	32	2	79,4	143,3	132,0	6000

// H10W3320

Split Flange Clamp 3000 PSI J518 Code 61 - FHL

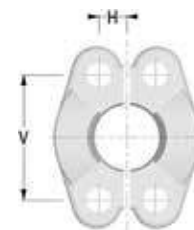

Item Code	ID	FD	V	H
	Dash	in	mm	mm
1900451	-0800	1/2"	38,1	8,7
1900457	-1200	3/4"	47,6	11,1
1900452	-1600	1"	52,4	13,1
1900454	-2000	1 1/4"	58,7	15,1
1900453	-2400	1 1/2"	69,9	17,9
1900455	-3200	2"	77,8	21,4
1900456	-4000	2 1/2"	89,0	25,5
1900458	-4800	3"	106,0	31,0
1901123	-5600	3 1/2"	120,0	35,0
1900715	-6400	4"	130,0	39,0

// H10W3620

Split Flange Clamp 6000 PSI J518 Code 62 - FHS

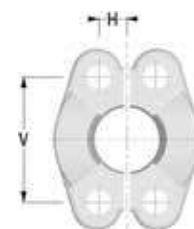

Item Code	ID	FD	V	H
	Dash	in	mm	mm
1900445	-0800	1/2"	40,5	9,1
1900450	-1200	3/4"	50,8	11,9
1900446	-1600	1"	57,2	13,9
1900448	-2000	1 1/4"	66,7	15,9
1900447	-2400	1 1/2"	79,4	18,3
1900449	-3200	2"	96,8	22,2

Dimensions shown may be changed without prior notice

// H10W3310

4 Hole Flange Clamp 3000 PSI J518 Code 61 - VHL

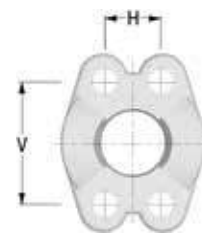

Item Code	ID	FD	V	H
	Dash	in	mm	mm
1900442	-1200	3/4"	47,6	22,2
1900437	-1600	1"	52,4	26,2
1900439	-2000	1 1/4"	58,7	30,2
1900438	-2400	1 1/2"	69,9	35,8
1900440	-3200	2"	77,8	42,8

// H10W3610

4 Hole Flange Clamp 6000 PSI J518 Code 62 - VHS

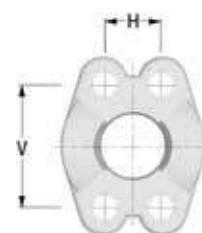

Item Code	ID	FD	V	H
	Dash	in	mm	mm
1900428	-0800	1/2"	40,5	18,2
1900433	-1200	3/4"	50,8	23,8
1900429	-1600	1"	57,2	27,8
1900431	-2000	1 1/4"	66,7	31,8
1900430	-2400	1 1/2"	79,4	36,6
1900432	-3200	2"	96,8	44,4
1900910	-4000	2 1/2"	123,8	58,7



// MULTISPIRAL

// FERRULES	101	// NPTF INSERTS	108
// BSP INSERTS	102	// ORFS INSERTS	109
// DIN METRIC INSERTS	104	// SAE FLANGES	111
// JIC 37° INSERTS	106	// SUPERCAT FLANGES	114

Dimensions shown may be changed without prior notice

// FERRULES

// H1300SK4 Multispiral Ferrule

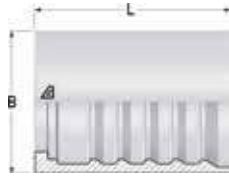

Item Code	ID			B	L
	Dash	mm	in		
1240185	12	19,0	3/4"	38,0	59,0
1240186	16	25,0	1"	46,0	64,0
1240187	20	31,0	1 1/4"	56,0	91,0
1240188	24	38,0	1 1/2"	62,0	91,0
1240189	32	51,0	2"	78,0	115,0

// H1300NS4 Multispiral Ferrule

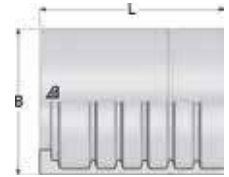

Item Code	ID			B	L
	Dash	mm	in		
1236599	12	19,0	3/4"	44,0	55,0
1236600	16	25,0	1"	51,0	64,0
1236601	20	31,0	1 1/4"	61,0	99,0
1236602	24	38,0	1 1/2"	70,0	89,5
1236603	32	51,0	2"	87,0	125,0

// H1300NS6 Multispiral Ferrule

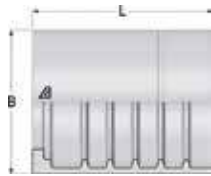

Item Code	ID			B	L
	Dash	mm	in		
1236604	20	31,0	1 1/4"	65,0	99,0
1236605	24	38,0	1 1/2"	73,0	89,5
1236606	32	51,0	2"	88,9	125,0

// BSP INSERTS

// H1310510

**BSP Male 60° Flare
AGR**

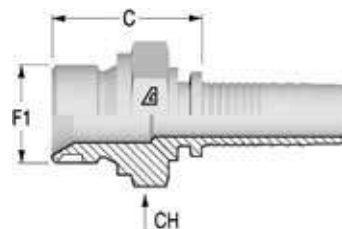

Item Code	Tail/Head	Nut Type	ID			F1	F1	C	CH
	Dash		Dash	mm	in	Dash Size			
1238090	-1212	NA	12	19,0	3/4"	12	3/4-14	37,5	32,0
1226162	-1616	NA	16	25,0	1"	16	1-11	44,5	41,0
1230555	-2020	NA	20	32,0	1 1/4"	20	1 1/4-11	95,5	50,0
1241600	-2424	NA	24	38,0	1 1/2"	24	1 1/2-11	56,0	55,0
1241601	-3232	NA	32	51,0	2"	32	2-11	71,5	70,0

// H1320812

**BSP Female 60° Cone with O-Ring
DKOR**

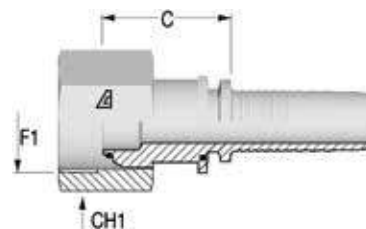

Item Code	Tail/Head	Nut Type	ID			F1	F1	C	CH1
	Dash		Dash	mm	in	Dash Size			
1226178	-1212	TN	12	19,0	3/4"	12	3/4-14	25,2	32,0
1241616	-1216	TN	12	19,0	3/4"	16	1-11	27,7	38,0
1226179	-1616	TN	16	25,0	1"	16	1-11	31,0	38,0
1241617	-1620	TN	16	25,0	1"	20	1 1/4-11	32,0	50,0
1238241	-2020	TN	20	32,0	1 1/4"	20	1 1/4-11	35,0	50,0
1239857	-2424	TN	24	38,0	1 1/2"	24	1 1/2-11	38,8	55,0
1238240	-3232	TN	32	51,0	2"	32	2-11	49,0	70,0

Dimensions shown may be changed without prior notice

// H1320842

**45° BSPP Female 60° Cone with O-Ring
DKOR 45
Solid one piece**

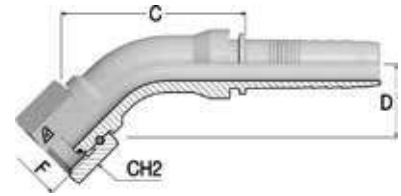

Item Code	Tail/Head	Nut Type	ID			F1	F1	C	D Drop	CH1
	Dash		Dash	mm	in	Dash Size				
1241628	-1212	TN	12	19,0	3/4"	12	3/4-14	75,2	30,0	32,0
1237423	-1616	TN	16	25,0	1"	16	1-11	92,1	40,0	38,0
1241629	-2020	TN	20	32,0	1 1/4"	20	1 1/4-11	90,4	40,0	50,0
1242138	-2424	TN	24	38,0	1 1/2"	24	1 1/2-11	113,0	46,0	55,0
1241630	-3232	TN	32	51,0	2"	32	2-11	153,5	60,0	70,0

// H1320892

**90° BSPP Female 60° Cone with O-Ring
DKOR 90
Solid one piece**

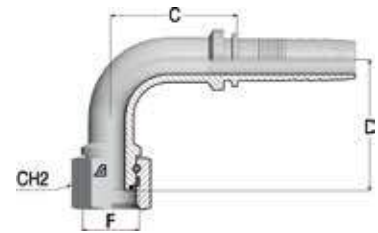

Item Code	Tail/Head	Nut Type	ID			F1	F1	C	D Drop	CH1
	Dash		Dash	mm	in	Dash Size				
1226180	-1212	TN	12	19,0	3/4"	12	3/4-14	59,1	61,0	32,0
1226181	-1616	TN	16	25,0	1"	16	1-11	73,7	71,0	38,0
1241625	-2020	TN	20	32,0	1 1/4"	20	1 1/4-11	84,3	83,0	50,0
1238242	-2424	TN	24	38,0	1 1/2"	24	1 1/2-11	98,7	96,0	55,0
1241626	-3232	TN	32	51,0	2"	32	2-11	140,5	130,0	70,0

// DIN METRIC INSERTS

// H1311210

Metric Male 24° Seat - Heavy
DIN 3853 - CES

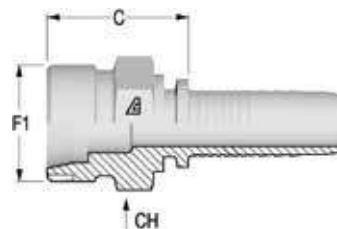

Item Code	Tail/Head	Nut Type	ID			F1	OD1	C	CH
	Dash/mm		Dash	mm	in		mm	mm	mm
1241605	-1236	NA	12	19,0	3/4"	M36X2	25	36,5	36,0
1226164	-1642	NA	16	25,0	1"	M42X2	30	36,2	46,0
1226165	-2052	NA	20	32,0	1 1/4"	M52X2	38	51,0	55,0

// H1321613

Metric Female 24° Cone with O-Ring - Heavy
DIN 3865 - DKOS

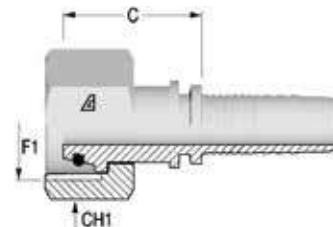

Item Code	Tail/Head	Nut Type	ID			F1	OD1	C	CH1
	Dash/mm		Dash	mm	in		mm	mm	mm
1226182	-1230	TN	12	19,0	3/4"	M30X2	20	36,8	36,0
1240224	-1636	TN	16	25,0	1"	M36X2	25	46,0	46,0
1226184	-1642	SN	16	25,0	1"	M42X2	30	45,2	50,0
1242139	-2042	TN	20	32,0	1 1/4"	M42X2	30	51,0	50,0
1226185	-2052	SN	20	32,0	1 1/4"	M52X2	38	51,1	60,0
1238244	-2452	TN	24	38,0	1 1/2"	M52X2	38	58,0	60,0

Dimensions shown may be changed without prior notice

// H1321643

45° Metric Female 24° Cone with O-Ring - Heavy
DIN 3865 - DKOS 45
Solid one piece

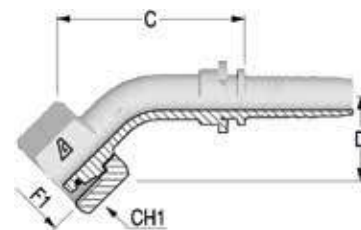

Item Code	Tail/Head Dash/mm	Nut Type	ID			F1	OD1 mm	C mm	D Drop mm	CH1 mm
			Dash	mm	in					
1237408	-1236	SN	12	19,0	3/4"	M36X2	25	70,4	33,0	46,0
1242140	-1636	TN	16	25,0	1"	M36X2	25	93,0	37,5	46,0
1237422	-1642	SN	16	25,0	1"	M42X2	30	109,5	35,5	50,0
1238246	-2052	SN	20	32,0	1 1/4"	M52X2	38	112,0	45,0	60,0

// H1321693

90° Metric Female 24° Cone with O-Ring - Heavy
DIN 3865 - DKOS 90
Solid one piece

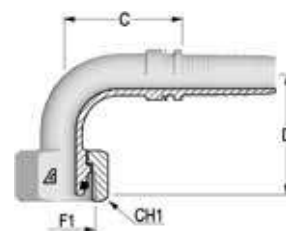

Item Code	Tail/Head Dash/mm	Nut Type	ID			F1	OD1 mm	C mm	D Drop mm	CH1 mm
			Dash	mm	in					
1241633	-1230	TN	12	19,0	3/4"	M30X2	20	65,5	67,5	36,0
1237409	-1236	SN	12	19,0	3/4"	M36X2	25	51,0	59,5	46,0
1240225	-1636	TN	16	25,0	1"	M36X2	25	75,6	82,0	46,0
1237410	-1642	SN	16	25,0	1"	M42X2	30	85,0	70,0	50,0
1238248	-2052	SN	20	32,0	1 1/4"	M52X2	38	97,0	92,0	60,0

// JIC 37° INSERTS

// H1312510

**JIC Male 37° Cone
AGJ**

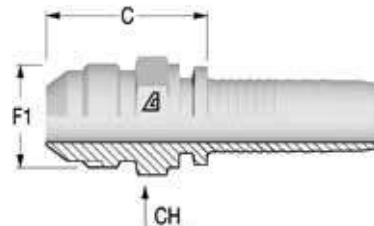

Item Code	Tail/Head	Nut Type	ID			F1	F1	C	CH
	Dash		Dash	mm	in	Dash Size			
1226168	-1212	NA	12	19,0	3/4"	12	1 1/16-12	38,5	27,0
1226169	-1616	NA	16	25,0	1"	16	1 5/16-12	45,5	36,0
1226170	-2020	NA	20	32,0	1 1/4"	20	1 5/8-12	51,5	46,0
1226171	-2424	NA	24	38,0	1 1/2"	24	1 7/8-12	57,5	50,0
1238091	-3232	NA	32	51,0	2"	32	2 1/2-12	77,0	65,0

// H1322512

**JIC Female 37° Seat
DKJ**

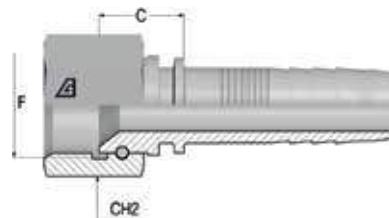

Item Code	Tail/Head	Nut Type	ID			F1	F1	C	CH1
	Dash		Dash	mm	in	Dash Size			
1241618	-1212	TN	12	19,0	3/4"	12	1 1/16-12	22,2	32,0
1241619	-1216	TN	12	19,0	3/4"	16	1 5/16-12	25,0	38,0
1241620	-1616	TN	16	25,0	1"	16	1 5/16-12	27,0	38,0
1241621	-1620	TN	16	25,0	1"	20	1 5/8-12	29,0	50,0
1241622	-2020	TN	20	32,0	1 1/4"	20	1 5/8-12	31,5	50,0
1241623	-2024	TN	20	32,0	1 1/4"	24	1 7/8-12	34,0	55,0
1241624	-2424	TN	24	38,0	1 1/2"	24	1 7/8-12	36,5	55,0
1238250	-3232	TN	32	51,0	2"	32	2 1/2-12	47,0	70,0

Dimensions shown may be changed without prior notice

// H1322542

**45° JIC Female 37° Seat - Medium Drop
DKJ 45M
Solid one piece**

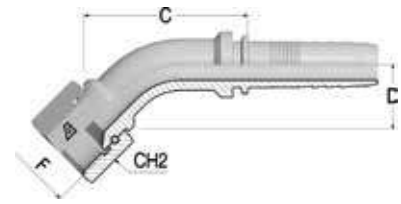

Item Code	Tail/Head	Nut Type	ID			F1		F1	C	D Drop	CH1
	Dash		Dash	mm	in	Dash Size	mm				
1226205	-1212	TN	12	19,0	3/4"	12	1 1/16-12	69,5	27,5	32,0	
1241631	-1216	TN	12	19,0	3/4"	16	1 5/16-12	69,0	33,5	38,0	
1226206	-1616	TN	16	25,0	1"	16	1 5/16-12	84,8	31,0	38,0	
1238251	-2020	TN	20	32,0	1 1/4"	20	1 5/8-12	99,0	37,0	50,0	
1226207	-2424	TN	24	38,0	1 1/2"	24	1 7/8-12	118,3	43,5	55,0	
1238252	-3232	TN	32	51,0	2"	32	2 1/2-12	162,3	51,5	70,0	

// H1322592

**90° JIC Female 37° Seat - Medium Drop
DKJ 90M
Solid one piece**

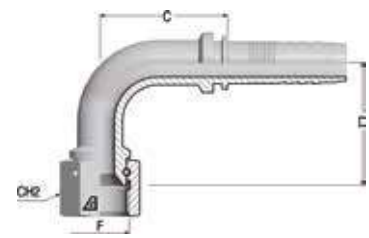

Item Code	Tail/Head	Nut Type	ID			F1		F1	C	D Drop	CH1
	Dash		Dash	mm	in	Dash Size	mm				
1226209	-1212	TN	12	19,0	3/4"	12	1 1/16-12	59,1	57,0	32,0	
1226211	-1216	TN	12	19,0	3/4"	16	1 5/16-12	58,1	63,5	38,0	
1226212	-1616	TN	16	25,0	1"	16	1 5/16-12	75,7	67,0	38,0	
1238254	-2020	TN	20	32,0	1 1/4"	20	1 5/8-12	84,0	78,0	50,0	
1230690	-2424	TN	24	38,0	1 1/2"	24	1 7/8-12	105,3	92,0	55,0	
1238255	-3232	TN	32	51,0	2"	32	2 1/2-12	147,5	135,0	70,0	

// NPTF INSERTS

// H1312810

**NPTF Male 60° Seat
AGN**

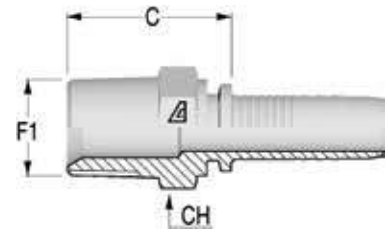

Item Code	Tail/Head	Nut Type	ID			F1	F1	C	CH
	Dash		Dash	mm	in	Dash Size		mm	mm
1226172	-1212	NA	12	19,0	3/4"	12	3/4-14	35,5	27,0
1226173	-1616	NA	16	25,0	1"	16	1-11 1/2	46,5	36,0
1238093	-2020	NA	20	32,0	1 1/4"	20	1 1/4-11 1/2	41,0	46,0
1226174	-2424	NA	24	38,0	1 1/2"	24	1 1/2-11 1/2	55,5	50,0
1238095	-3232	NA	32	51,0	2"	32	2-11 1/2	69,2	65,0

Dimensions shown may be changed without prior notice

// ORFS INSERTS

// H1312410

ORFS Male

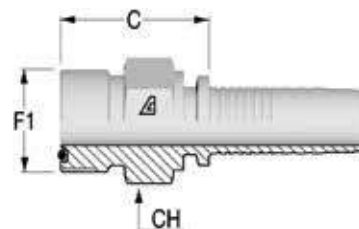

Item Code	Tail/Head	Nut Type	ID			F1	F1	C	CH
	Dash		Dash	mm	in	Dash Size		mm	mm
1230556	-1212	NA	12	19,0	3/4"	12	1 3/16-12	32,7	32,0
1226166	-1616	NA	16	25,0	1"	16	1 7/16-12	35,7	38,0
1230557	-2020	NA	20	32,0	1 1/4"	20	1 11/16-12	38,7	46,0
1226167	-2424	NA	24	38,0	1 1/2"	24	2-12	41,8	55,0

// H1322411

ORFS Female with Stem Hexagon

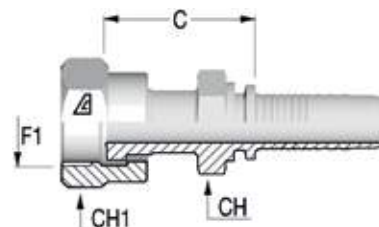

Item Code	Tail/Head	Nut Type	ID			F1	F1	C	CH	CH1
	Dash		Dash	mm	in	Dash Size		mm	mm	mm
1226190	-1212	CR	12	19,0	3/4"	12	1 3/16-12	44,5	30,0	36,0
1226191	-1216	CR	12	19,0	3/4"	16	1 7/16-12	50,5	36,0	41,0
1242141	-1612	CR	16	25,0	1"	12	1 3/16-12	42,0	32,0	36,0
1226192	-1616	CR	16	25,0	1"	16	1 7/16-12	52,5	36,0	41,0
1226193	-1620	CR	16	25,0	1"	20	1 11/16-12	53,5	41,0	50,0
1226194	-2020	CR	20	32,0	1 1/4"	20	1 11/16-12	56,0	41,0	50,0
1226195	-2424	CR	24	38,0	1 1/2"	24	2-12	62,5	50,0	60,0

// H1322441

45° ORFS Female - Medium Drop
DK ORFS 45M
Solid one piece

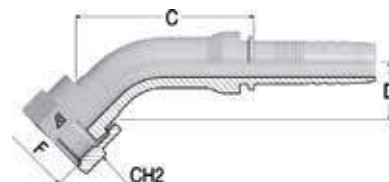

Item Code	Tail/Head	Nut Type	ID			F1	F1	C	D Drop	CH1
	Dash		Dash	mm	in	Dash Size				
1226196	-1212	CR	12	19,0	3/4"	12	1 3/16-12	32,5	26,0	36,0
1226197	-1216	CR	12	19,0	3/4"	16	1 7/16-12	31,2	28,0	41,0
1226198	-1616	CR	16	25,0	1"	16	1 7/16-12	94,0	28,0	41,0
1241634	-1620	CR	16	25,0	1"	20	1 11/16-12	88,0	28,0	50,0
1238249	-2020	CR	20	32,0	1 1/4"	20	1 11/16-12	110,0	36,5	50,0

// H1322491

90° ORFS Female - Medium Drop
DK ORFS 90M
Solid one piece

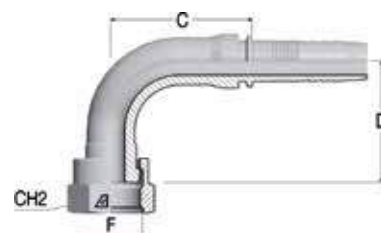

Item Code	Tail/Head	Nut Type	ID			F1	F1	C	D Drop	CH1
	Dash		Dash	mm	in	Dash Size				
1226200	-1212	CR	12	19,0	3/4"	12	1 3/16-12	67,6	58,0	36,0
1226201	-1216	CR	12	19,0	3/4"	16	1 7/16-12	69,6	58,0	36,0
1226202	-1616	CR	16	25,0	1"	16	1 7/16-12	79,6	66,0	41,0
1241635	-1620	CR	16	25,0	1"	20	1 11/16-12	73,0	66,0	50,0
1226203	-2020	CR	20	32,0	1 1/4"	20	1 11/16-12	102,4	81,0	50,0

Dimensions shown may be changed without prior notice

// SAE FLANGES

// H1343310

Flange SAE 3000 PSI J518 Code 61 - SFL

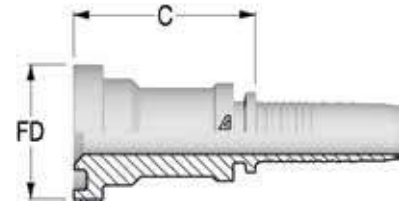

Item Code	Tail/Head	ID		Flange	Flange Size	C	FD	WP	
	Dash	Dash	mm	in		Dash Size	mm		mm
1226222	-1212	12	19,0	3/4"	12	3/4	43,5	38,1	5000
1226224	-1616	16	25,0	1"	16	1	53,5	44,5	5000
1226225	-1620	16	25,0	1"	20	1 1/4	56,0	50,8	5000
1241602	-2016	20	32,0	1 1/4"	16	1	58,5	44,4	5000
1226227	-2020	20	32,0	1 1/4"	20	1 1/4	58,5	50,8	5000
1241604	-2024	20	32,0	1 1/4"	24	1 1/2	61,5	60,3	5000
1241603	-2420	24	38,0	1 1/2"	20	1 1/4	55,5	50,8	5000
1226228	-2424	24	38,0	1 1/2"	24	1 1/2	63,5	60,3	5000
1226229	-2432	24	38,0	1 1/2"	32	2	75,0	71,4	5000
1235374	-3232	32	50,0	2"	32	2	85,0	71,4	5000

// H1343340

45° Flange SAE 3000 PSI J518 Code 61 - SFL 45
Solid one piece

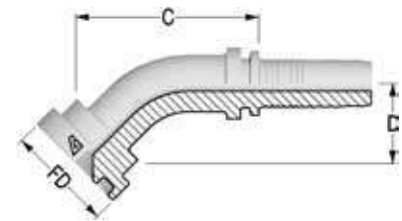

Item Code	Tail/Head	ID		Flange	Flange Size	FD	C	D Drop	WP	
	Dash	Dash	mm	in		Dash Size	mm	mm		mm
1226233	-1620	16	25,0	1"	20	1 1/4	50,8	88,9	32,5	5000
1226234	-2020	20	32,0	1 1/4"	20	1 1/4	50,8	94,3	38,5	5000
1226235	-2424	24	38,0	1 1/2"	24	1 1/2	60,3	99,8	43,0	5000
1233534	-3232	32	50,0	2"	32	2	71,4	154,0	54,0	5000

// H1343390

90° Flange SAE 3000 PSI J518 Code 61 - SFL 90
Solid one piece

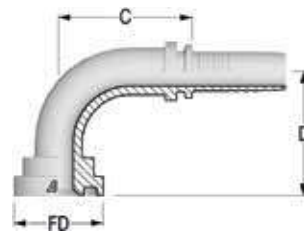

Item Code	Tail/Head	ID		Flange		Flange Size	FD	C	D Drop	WP
	Dash	Dash	mm	in	Dash Size					
1226241	-1616	16	25,0	1"	16	1	44,5	78,1	64,0	5000
1226242	-1620	16	25,0	1"	20	1 1/4	50,8	74,7	69,0	5000
1226244	-2020	20	32,0	1 1/4"	20	1 1/4	50,8	92,0	81,0	5000
1241608	-2024	20	32,0	1 1/4"	24	1 1/2	60,3	87,0	85,0	5000
1226245	-2424	24	38,0	1 1/2"	24	1 1/2	60,3	103,0	93,0	5000
1226246	-2432	24	38,0	1 1/2"	32	2	71,4	137,8	97,0	5000
1235375	-3232	32	50,0	2"	32	2	71,4	139,0	130,0	5000

// H1343610

Flange SAE 6000 PSI J518 Code 62 - SFS

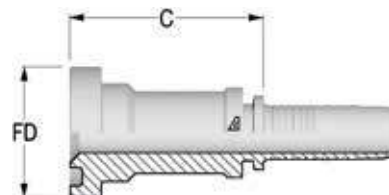

Item Code	Tail/Head	ID		Flange		Flange Size	C	FD	WP
	Dash	Dash	mm	in	Dash Size				
1226247	-1212	12	19,0	3/4"	12	3/4	53,5	41,3	6000
1226248	-1216	12	19,0	3/4"	16	1	56,5	47,6	6000
1226623	-1612	16	25,0	1"	12	3/4	58,5	41,3	6000
1226250	-1616	16	25,0	1"	16	1	58,5	47,6	6000
1226624	-1620	16	25,0	1"	20	1 1/4	65,5	54,0	6000
1236992	-2016	20	32,0	1 1/4"	16	1	61,0	47,6	6000
1226252	-2020	20	32,0	1 1/4"	20	1 1/4	64,0	54,0	6000
1226253	-2024	20	32,0	1 1/4"	24	1 1/2	74,0	63,5	6000
1241614	-2420	24	38,0	1 1/2"	20	1 1/4	71,0	54,0	6000
1226254	-2424	24	38,0	1 1/2"	24	1 1/2	76,0	63,5	6000
1226255	-2432	24	38,0	1 1/2"	32	2	88,0	79,4	6000
1241615	-3224	32	51,0	2"	24	1 1/2	86,0	63,5	6000
1235378	-3232	32	50,0	2"	32	2	103,0	79,4	6000

Dimensions shown may be changed without prior notice

// H1343640

45° Flange SAE 6000 PSI J518 Code 62 - SFS 45
Solid one piece

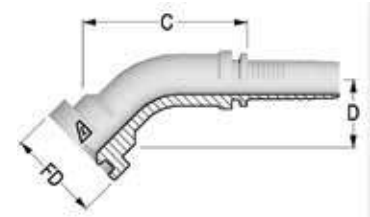

Item Code	Tail/Head		ID		Flange		FD	C	D Drop	WP
	Dash	Dash	mm	in	Dash Size	Flange Size				
1226261	-1212	12	19,0	3/4"	12	3/4	41,3	62,8	30,0	6000
1226262	-1216	12	19,0	3/4"	16	1	47,6	65,4	33,0	6000
1241609	-1612	16	25,0	1"	12	3/4	41,3	77,0	29,5	6000
1226263	-1616	16	25,0	1"	16	1	47,6	82,9	38,5	6000
1226264	-1620	16	25,0	1"	20	1 1/4	54,0	78,0	44,0	6000
1242142	-2016	20	32,0	1 1/4"	16	1	47,6	104,7	34,5	6000
1238305	-2020	20	32,0	1 1/4"	20	1 1/4	54,0	103,0	41,0	6000
1241610	-2024	20	32,0	1 1/4"	24	1 1/2	63,5	117,0	48,0	6000
1226265	-2424	24	38,0	1 1/2"	24	1 1/2	63,5	122,5	48,0	6000
1226266	-2432	24	38,0	1 1/2"	32	2	79,4	109,6	55,0	6000
1235379	-3232	32	50,0	2"	32	2	79,4	177,0	61,0	6000

// H1343690

90° Flange SAE 6000 PSI J518 Code 62 - SFS 90
Solid one piece

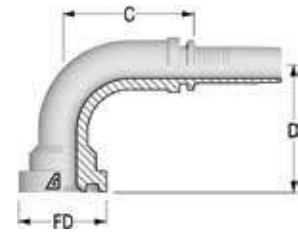

Item Code	Tail/Head		ID		Flange		FD	C	D Drop	WP
	Dash	Dash	mm	in	Dash Size	Flange Size				
1226270	-1212	12	19,0	3/4"	12	3/4	41,3	64,7	64,0	6000
1226271	-1216	12	19,0	3/4"	16	1	47,6	64,7	66,0	6000
1226633	-1612	16	25,0	1"	12	3/4	41,3	74,7	61,0	6000
1226273	-1616	16	25,0	1"	16	1	47,6	74,8	74,0	6000
1226274	-1620	16	25,0	1"	20	1 1/4	54,0	78,8	85,0	6000
1241611	-2016	20	32,0	1 1/4"	16	1	47,6	87,0	72,0	6000
1230765	-2020	20	32,0	1 1/4"	20	1 1/4	54,0	96,0	91,0	6000
1238310	-2024	20	32,0	1 1/4"	24	1 1/2	63,5	99,0	103,5	6000
1226276	-2424	24	38,0	1 1/2"	24	1 1/2	63,5	113,8	109,0	6000
1226277	-2432	24	38,0	1 1/2"	32	2	79,4	118,4	121,5	6000
1235381	-3232	32	50,0	2"	32	2	79,4	172,0	131,0	6000

// SUPERCAT FLANGES

// H1343910

Flange SUPERCAT

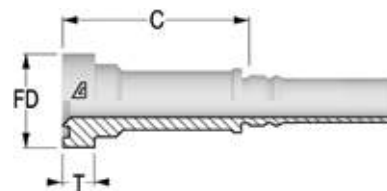

Item Code	Tail/Head	ID		Flange		Flange Size	FD	T	C
	Dash	Dash	mm	in	Dash Size		mm	mm	mm
1226278	-1212	12	19,0	3/4"	12	3/4	41,3	14,3	85,5
1226279	-1216	12	19,0	3/4"	16	1	47,6	14,3	85,5
1226280	-1616	16	25,0	1"	16	1	47,6	14,3	94,5
1226281	-1620	16	25,0	1"	20	1 1/4	54,0	14,3	94,5
1226282	-2020	20	32,0	1 1/4"	20	1 1/4	54,0	14,3	92,0
1226283	-2024	20	32,0	1 1/4"	24	1 1/2	63,5	14,3	87,0

// H1343940

45° Flange SUPERCAT Solid one piece

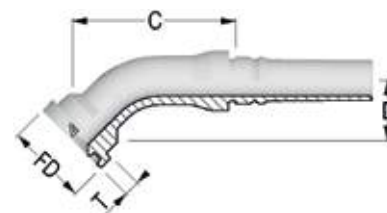

Item Code	Tail/Head	ID		Flange		Flange Size	FD	T	C	D Drop
	Dash	Dash	mm	in	Dash Size		mm	mm	mm	mm
1226289	-1212	12	19,0	3/4"	12	3/4	41,3	14,3	107,0	34,0
1241612	-1216	12	19,0	3/4"	16	1	47,6	14,3	112,0	34,0
1226290	-1616	16	25,0	1"	16	1	47,6	14,3	129,0	42,5
1226291	-1620	16	25,0	1"	20	1 1/4	54,0	14,3	128,0	40,0
1226292	-2020	20	32,0	1 1/4"	20	1 1/4	54,0	14,3	150,0	45,1
1238317	-2024	20	32,0	1 1/4"	24	1 1/2	63,5	14,3	152,0	60,0

Dimensions shown may be changed without prior notice

// H1343990

**90° Flange SUPERCAT
Solid one piece**

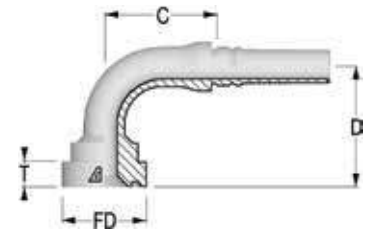

Item Code	Tail/Head	ID		Flange		Flange Size	FD	T	C	D Drop
	Dash	Dash	mm	in	Dash Size					
1226297	-1212	12	19,0	3/4"	12	3/4	41,3	14,3	67,2	67,0
1226298	-1216	12	19,0	3/4"	16	1	47,6	14,3	68,7	70,0
1226299	-1616	16	25,0	1"	16	1	47,6	14,3	84,8	79,0
1226301	-1620	16	25,0	1"	20	1 1/4	54,0	14,3	79,8	82,5
1238312	-2020	20	32,0	1 1/4"	20	1 1/4	54,0	14,3	97,0	93,0
1238315	-2024	20	32,0	1 1/4"	24	1 1/2	63,5	14,3	97,0	101,0



// INTERLOCK

// FERRULES	117
// HOSE MENDER	118
// BSP INSERTS	119
// DIN METRIC INSERTS.....	121
// JIC 37° INSERTS.....	123

// NPTF INSERTS	125
// ORFS INSERTS.....	126
// SAE FLANGES	128
// SUPERCAT FLANGES.....	132
// HAMMER UNION	133

Dimensions shown may be changed without prior notice

// FERRULES

// H1400200

Interlock Ferrule

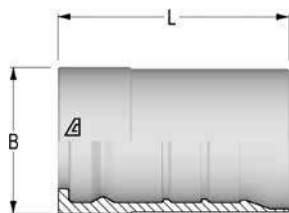

Item Code	ID			B	L
	Dash	mm	in		
1201571	06	10,0	3/8"	27,0	49,0
1201856	08	13,0	1/2"	30,0	52,5
1201502	10	16,0	5/8"	34,0	57,5
1201503	12	19,0	3/4"	38,0	60,2
1245056	16	25,0	1"	46,0	74,7
1201504	16	25,0	1"	46,0	74,7
1200098	20	31,0	1 1/4"	55,0	88,2
1200099	24	38,0	1 1/2"	62,0	94,2
1201284	32	51,0	2"	78,0	99,2

// H1T00600

Interlock Ferrule

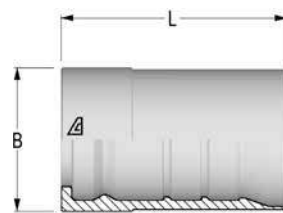

Item Code	ID			B	L
	Dash	mm	in		
1225872	32	51,0	2"	88,1	108,2

// H1400301

Interlock Ferrule

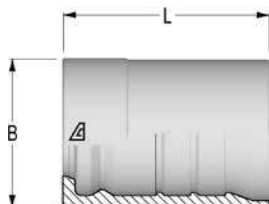

Item Code	ID			B	L
	Dash	mm	in		
1202585	10	16,0	5/8"	35,5	57,5
1202730	12	19,0	3/4"	43,5	60,0
1202222	16	25,0	1"	52,0	75,0
1201761	20	31,0	1 1/4"	62,0	88,0
1201805	24	38,0	1 1/2"	69,5	94,0
1202006	32	51,0	2"	88,0	99,0

// HOSE MENDER

// H14C5610

Hose Mender



Item Code	Tail/Head	ID			F1
	Dash	Dash	mm	in	Dash Size
1219636	-1010	10	16,0	5/8"	10
1235392	-2020	20	32,0	1 1/4"	20
1235393	-2424	24	38,0	1 1/2"	24
1235394	-3232	32	51,0	2"	32

Dimensions shown may be changed without prior notice

// BSP INSERTS

// H1410510

**BSP Male 60° Flare
AGR**

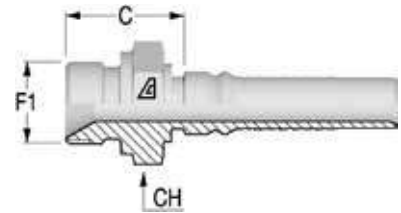

Item Code	Tail/Head	Nut Type	ID			F1	F1	C	CH
	Dash		Dash	mm	in	Dash Size			
1200218	-1212	NA	12	19,0	3/4"	12	3/4-14	34,0	32,0
1200239	-1616	NA	16	25,0	1"	16	1-11	40,0	41,0
1201219	-2020	NA	20	32,0	1 1/4"	20	1 1/4-11	45,2	50,0
1200280	-2424	NA	24	38,0	1 1/2"	24	1 1/2-11	48,5	55,0
1201080	-3232	NA	32	51,0	2"	32	2-11	55,5	70,0

// H1410710

**BSPT Male
AGR K**

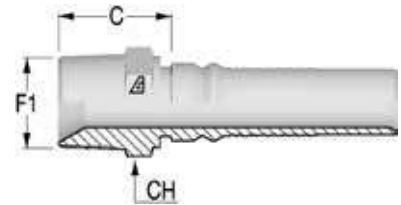

Item Code	Tail/Head	Nut Type	ID			F1	F1	C	CH
	Dash		Dash	mm	in	Dash Size			
1200215	-1212	NA	12	19,0	3/4"	12	3/4-14	32,0	27,0
1200237	-1616	NA	16	25,0	1"	16	1-11	42,0	36,0
1200261	-2020	NA	20	32,0	1 1/4"	20	1 1/4-11	46,2	46,0
1200278	-2424	NA	24	38,0	1 1/2"	24	1 1/2-11	48,0	50,0

// H1420812

**BSP Female 60° Cone with O-Ring
DKOR**

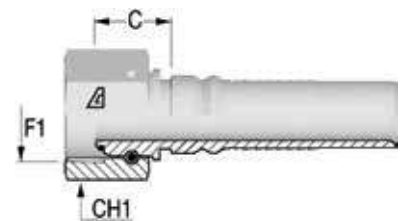

Item Code	Tail/Head	Nut Type	ID			F1	F1	C	CH1
	Dash		Dash	mm	in	Dash Size			
1214247	-0808	CR	08	13,0	1/2"	08	1/2-14	19,5	27,0
1202424	-1212	TN	12	19,0	3/4"	12	3/4-14	22,5	32,0
1202440	-1616	TN	16	25,0	1"	16	1-11	25,5	38,0
1201132	-2020	TN	20	32,0	1 1/4"	20	1 1/4-11	30,2	50,0
1201134	-2424	TN	24	38,0	1 1/2"	24	1 1/2-11	33,5	55,0
1201136	-3232	TN	32	51,0	2"	32	2-11	35,0	70,0

// H1420842

**45° BSPP Female 60° Cone with O-Ring
DKOR 45
Solid one piece**

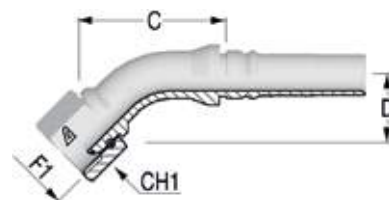

Item Code	Tail/Head	Nut Type	ID			F1		F1	C	D Drop	CH1
	Dash		Dash	mm	in	Dash Size	mm				
1202447	-1212	TN	12	19,0	3/4"	12	3/4-14	72,0	30,0	32,0	
1202446	-1616	TN	16	25,0	1"	16	1-11	81,0	34,0	38,0	
1202444	-2020	TN	20	32,0	1 1/4"	20	1 1/4-11	97,2	40,0	50,0	
1202442	-2424	TN	24	38,0	1 1/2"	24	1 1/2-11	113,0	46,0	55,0	
1201535	-3232	TN	32	51,0	2"	32	2-11	151,0	60,0	70,0	

// H1420892

**90° BSPP Female 60° Cone with O-Ring
DKOR 90
Solid one piece**

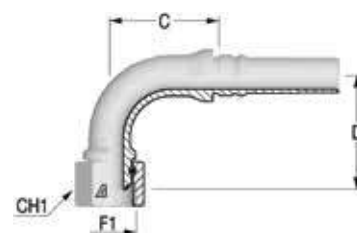

Item Code	Tail/Head	Nut Type	ID			F1		F1	C	D Drop	CH1
	Dash		Dash	mm	in	Dash Size	mm				
1200217	-1212	TN	12	19,0	3/4"	12	3/4-14	58,0	61,0	32,0	
1202445	-1616	TN	16	25,0	1"	16	1-11	75,0	71,0	38,0	
1202443	-2020	TN	20	32,0	1 1/4"	20	1 1/4-11	79,2	83,0	50,0	
1202441	-2424	TN	24	38,0	1 1/2"	24	1 1/2-11	93,5	96,0	55,0	
1200288	-3232	TN	32	51,0	2"	32	2-11	134,0	125,0	70,0	

Dimensions shown may be changed without prior notice

// DIN METRIC INSERTS

// H1411210

Metric Male 24° Seat - Heavy
DIN 3853 - CES

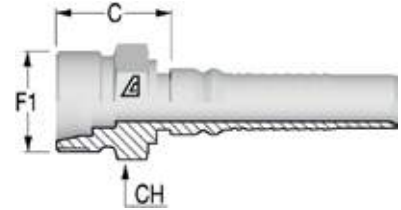

Item Code	Tail/Head Dash/mm	Nut Type	ID			F1	OD1 mm	C mm	CH mm
			Dash	mm	in				
1216929	-0824	NA	08	13,0	1/2"	M24X1.5	16	27,0	24,0
1201077	-1030	NA	10	16,0	5/8"	M30X2	20	31,0	32,0
1200212	-1236	NA	12	19,0	3/4"	M36X2	25	35,0	36,0
1200236	-1642	NA	16	25,0	1"	M42X2	30	40,0	46,0
1200260	-2052	NA	20	32,0	1 1/4"	M52X2	38	45,2	55,0

// H1421613

Metric Female 24° Cone with O-Ring - Heavy
DIN 3865 - DKOS

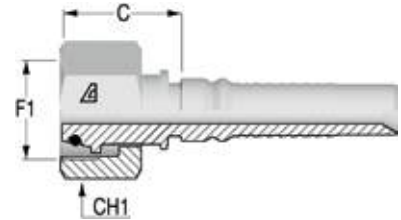

Item Code	Tail/Head Dash/mm	Nut Type	ID			F1	OD1 mm	C mm	CH1 mm
			Dash	mm	in				
1201857	-0824	SN	08	13,0	1/2"	M24X1.5	16	29,6	30,0
1201118	-1030	SN	10	16,0	5/8"	M30X2	20	34,4	36,0
1202584	-1230	TN	12	19,0	3/4"	M30X2	20	37,5	36,0
1201092	-1236	SN	12	19,0	3/4"	M36X2	25	37,6	46,0
1202887	-1636	TN	16	25,0	1"	M36X2	25	38,8	46,0
1201125	-1642	SN	16	25,0	1"	M42X2	30	40,7	50,0
1216935	-2042	TN	20	32,0	1 1/4"	M42X2	30	43,6	50,0
1201129	-2052	SN	20	32,0	1 1/4"	M52X2	38	45,3	60,0
1216936	-2452	TN	24	38,0	1 1/2"	M52X2	38	50,8	60,0

// H1421643

**45° Metric Female 24° Cone with O-Ring - Heavy
DIN 3865 - DKOS 45
Solid one piece**

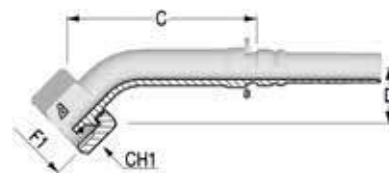

Item Code	Tail/Head Dash/mm	Nut Type	ID			F1	OD1 mm	C mm	D Drop mm	CH1 mm
			Dash	mm	in					
1216942	-0824	SN	08	13,0	1/2"	M24X1.5	16	83,0	29,0	30,0
1202073	-1030	SN	10	16,0	5/8"	M30X2	20	59,0	31,5	36,0
1202583	-1230	TN	12	19,0	3/4"	M30X2	20	74,0	33,0	36,0
1202079	-1236	SN	12	19,0	3/4"	M36X2	25	78,1	36,0	46,0
1216940	-1636	TN	16	25,0	1"	M36X2	25	86,5	37,5	46,0
1201724	-1642	SN	16	25,0	1"	M42X2	30	96,8	38,0	50,0
1202003	-2052	SN	20	32,0	1 1/4"	M52X2	38	112,7	48,0	60,0
1216941	-2452	TN	24	38,0	1 1/2"	M52X2	38	111,0	44,0	60,0

// H1421693

**90° Metric Female 24° Cone with O-Ring - Heavy
DIN 3865 - DKOS 90
Solid one piece**

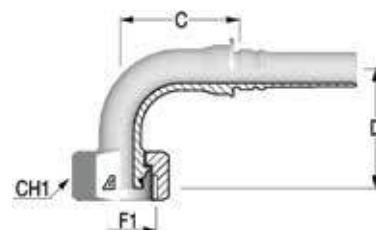

Item Code	Tail/Head Dash/mm	Nut Type	ID			F1	OD1 mm	C mm	D Drop mm	CH1 mm
			Dash	mm	in					
1203125	-0824	SN	08	13,0	1/2"	M24X1.5	16	52,0	50,0	30,0
1202072	-1030	SN	10	16,0	5/8"	M30X2	20	48,0	55,0	36,0
1202582	-1230	TN	12	19,0	3/4"	M30X2	20	61,0	67,5	36,0
1201723	-1236	SN	12	19,0	3/4"	M36X2	25	61,7	65,0	46,0
1203126	-1636	TN	16	25,0	1"	M36X2	25	76,5	76,5	46,0
1201740	-1642	SN	16	25,0	1"	M42X2	30	86,4	79,0	50,0
1201059	-2052	SN	20	32,0	1 1/4"	M52X2	38	90,9	101,0	60,0
1216945	-2452	TN	24	38,0	1 1/2"	M52X2	38	100,5	102,0	60,0

Dimensions shown may be changed without prior notice

// JIC 37° INSERTS

// H1412510

JIC Male 37° Cone
AGJ

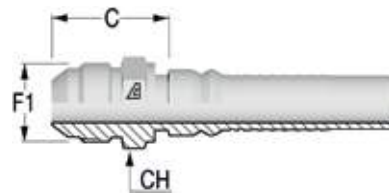

Item Code	Tail/Head	Nut Type	ID			F1	F1	C	CH
	Dash		Dash	mm	in	Dash Size			
1200216	-1212	NA	12	19,0	3/4"	12	1 1/16-12	37,0	32,0
1201094	-1216	NA	12	19,0	3/4"	16	1 5/16-12	40,0	36,0
1200238	-1616	NA	16	25,0	1"	16	1 5/16-12	41,0	36,0
1201787	-1620	NA	16	25,0	1"	20	1 5/8-12	44,5	46,0
1200262	-2020	NA	20	32,0	1 1/4"	20	1 5/8-12	45,7	46,0
1216931	-2024	NA	20	32,0	1 1/4"	24	1 7/8-12	49,7	50,0
1200279	-2424	NA	24	38,0	1 1/2"	24	1 7/8-12	50,0	50,0
1201798	-3232	NA	32	51,0	2"	32	2 1/2-12	61,0	65,0

// H1422512

JIC Female 37° Seat
DKJ

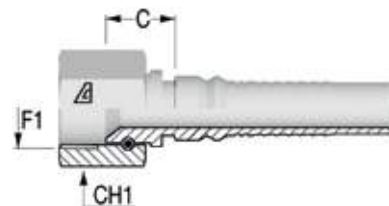

Item Code	Tail/Head	Nut Type	ID			F1	F1	C	CH1
	Dash		Dash	mm	in	Dash Size			
1201265	-1012	TN	10	16,0	5/8"	12	1 1/16-12	18,7	32,0
1201121	-1212	TN	12	19,0	3/4"	12	1 1/16-12	18,7	32,0
1201122	-1216	TN	12	19,0	3/4"	16	1 5/16-12	21,5	38,0
1201126	-1616	TN	16	25,0	1"	16	1 5/16-12	22,5	38,0
1201127	-1620	TN	16	25,0	1"	20	1 5/8-12	24,5	50,0
1201131	-2020	TN	20	32,0	1 1/4"	20	1 5/8-12	25,7	50,0
1216973	-2024	TN	20	32,0	1 1/4"	24	1 7/8-12	28,2	55,0
1201133	-2424	TN	24	38,0	1 1/2"	24	1 7/8-12	29,0	55,0
1201135	-3232	TN	32	51,0	2"	32	2 1/2-12	34,0	70,0

// H1422542

**45° JIC Female 37° Seat
DKJ 45
Solid one piece**

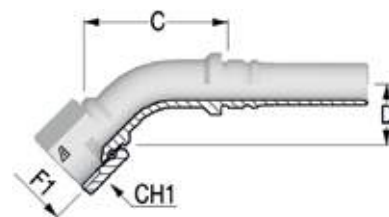

Item Code	Tail/Head	Nut Type	ID			F1	F1	C	D Drop	CH1
	Dash		Dash	mm	in	Dash Size				
1201485	-1212	TN	12	19,0	3/4"	12	1 1/16-12	66,0	27,5	32,0
1202098	-1216	TN	12	19,0	3/4"	16	1 5/16-12	72,0	30,0	38,0
1201486	-1616	TN	16	25,0	1"	16	1 5/16-12	79,5	31,0	38,0
1201487	-2020	TN	20	32,0	1 1/4"	20	1 5/8-12	93,0	37,0	50,0
1201765	-2424	TN	24	38,0	1 1/2"	24	1 7/8-12	121,0	38,0	55,0

// H1422592

**90° JIC Female 37° Seat
DKJ 90
Solid one piece**

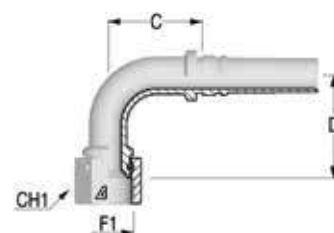

Item Code	Tail/Head	Nut Type	ID			F1	F1	C	D Drop	CH1
	Dash		Dash	mm	in	Dash Size				
1201488	-1212	TN	12	19,0	3/4"	12	1 1/16-12	45,0	57,0	32,0
1202103	-1216	TN	12	19,0	3/4"	16	1 5/16-12	58,0	60,5	38,0
1201489	-1616	TN	16	25,0	1"	16	1 5/16-12	71,0	67,0	38,0
1201490	-2020	TN	20	32,0	1 1/4"	20	1 5/8-12	79,2	78,0	50,0
1201491	-2424	TN	24	38,0	1 1/2"	24	1 7/8-12	94,5	92,0	55,0
1201796	-3232	TN	32	51,0	2"	32	2 1/2-12	132,0	120,5	70,0

Dimensions shown may be changed without prior notice

// NPTF INSERTS

// H1412810

**NPTF Male 60° Seat
AGN**

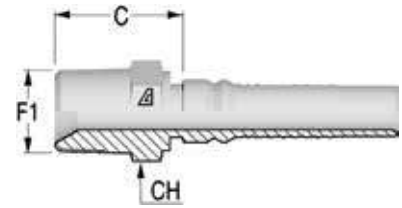

Item Code	Tail/Head	Nut Type	ID			F1	F1	C	CH
	Dash		Dash	mm	in	Dash Size			
1201609	-0606	NA	06	10,0	3/8"	06	3/8-18	26,5	19,0
1203127	-0808	NA	08	13,0	1/2"	08	1/2-14	30,0	22,0
1200193	-1212	NA	12	19,0	3/4"	12	3/4-14	32,0	27,0
1200219	-1616	NA	16	25,0	1"	16	1-11 1/2	42,0	36,0
1200240	-2020	NA	20	32,0	1 1/4"	20	1 1/4-11 1/2	46,2	46,0
1200263	-2424	NA	24	38,0	1 1/2"	24	1 1/2-11 1/2	48,0	50,0
1200281	-3232	NA	32	51,0	2"	32	2-11 1/2	53,2	65,0

// ORFS INSERTS

// H1412410 ORFS Male

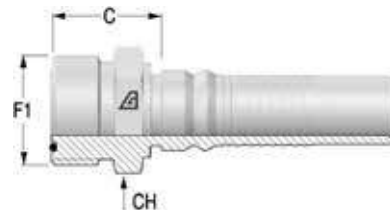

Item Code	Tail/Head	Nut Type	ID			F1	F1	C	CH
	Dash		Dash	mm	in	Dash Size			
1214664	-1212	NA	12	19,0	3/4"	12	1 3/16-12	30200,0	30,0
1231483	-1616	NA	16	25,0	1"	16	1 7/16-12	35,8	38,0
1226310	-2020	NA	20	32,0	1 1/4"	20	1 11/16-12	39,1	46,0
1226311	-2024	NA	20	32,0	1 1/4"	24	2-12	40,7	55,0
1226312	-2424	NA	24	38,0	1 1/2"	24	2-12	41,0	55,0

// H1422411 ORFS Female with Stem Hexagon

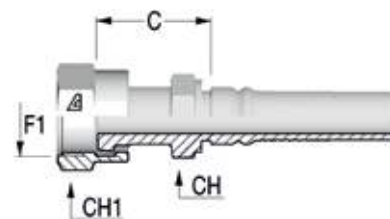

Item Code	Tail/Head	Nut Type	ID			F1	F1	C	CH	CH1
	Dash		Dash	mm	in	Dash Size				
1202864	-1012	CR	10	16,0	5/8"	12	1 3/16-12	40,0	30,0	36,0
1202099	-1212	CR	12	19,0	3/4"	12	1 3/16-12	40,0	30,0	36,0
1202106	-1216	CR	12	19,0	3/4"	16	1 7/16-12	43,0	36,0	41,0
1216952	-1612	CR	16	25,0	1"	12	1 3/16-12	42,0	32,0	36,0
1245057	-1616	CR	16	25,0	1"	16	1 7/16-12	47,0	36,0	41,0
1202071	-1616	CR	16	25,0	1"	16	1 7/16-12	47,0	36,0	41,0
1202107	-1620	CR	16	25,0	1"	20	1 11/16-12	49,0	46,0	50,0
1216955	-2016	CR	20	32,0	1 1/4"	16	1 7/16-12	47,2	41,0	41,0
1201807	-2020	CR	20	32,0	1 1/4"	20	1 11/16-12	47,2	46,0	50,0
1216956	-2424	CR	24	38,0	1 1/2"	24	2-12	52,0	50,0	60,0

Dimensions shown may be changed without prior notice

// H1422441

**45° ORFS Female
DK ORFS 45
Solid one piece**

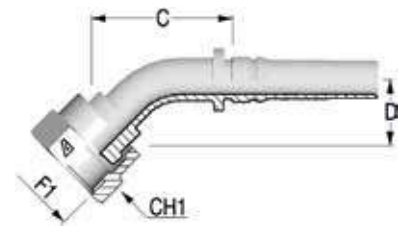

Item Code	Tail/Head	Nut Type	ID			F1	F1	C	D Drop	CH1
	Dash		Dash	mm	in	Dash Size				
1202108	-1212	CR	12	19,0	3/4"	12	1 3/16-12	77,7	26,0	36,0
1202109	-1216	CR	12	19,0	3/4"	16	1 7/16-12	68,4	28,0	41,0
1202110	-1616	CR	16	25,0	1"	16	1 7/16-12	114,0	28,0	41,0
1202111	-1620	CR	16	25,0	1"	20	1 11/16-12	83,4	28,0	50,0
1202112	-2020	CR	20	32,0	1 1/4"	20	1 11/16-12	100,7	33,0	50,0

// H1422491

**90° ORFS Female
DK ORFS 90
Solid one piece**

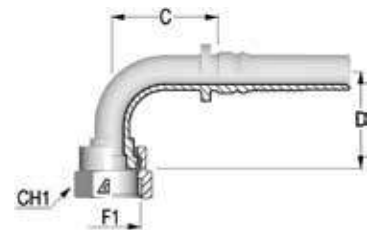

Item Code	Tail/Head	Nut Type	ID			F1	F1	C	D Drop	CH1
	Dash		Dash	mm	in	Dash Size				
1203123	-1012	CR	10	16,0	5/8"	12	1 3/16-12	48,1	58,0	36,0
1202117	-1212	CR	12	19,0	3/4"	12	1 3/16-12	64,2	58,0	36,0
1202116	-1216	CR	12	19,0	3/4"	16	1 7/16-12	66,2	58,0	41,0
1202115	-1616	CR	16	25,0	1"	16	1 7/16-12	75,2	66,0	41,0
1202114	-1620	CR	16	25,0	1"	20	1 11/16-12	73,2	66,0	50,0
1202113	-2020	CR	20	32,0	1 1/4"	20	1 11/16-12	91,7	81,0	50,0

// SAE FLANGES

// H1443310

Flange SAE 3000 PSI J518 Code 61 - SFL

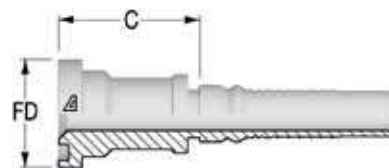

Item Code	Tail/Head	ID		Flange		Flange Size	C	FD	WP
	Dash	Dash	mm	in	Dash Size				
1200233	-1616	16	25,0	1"	16	1	49,0	44,5	5000
1200234	-1620	16	25,0	1"	20	1 1/4	51,5	50,8	4000
1200257	-2020	20	32,0	1 1/4"	20	1 1/4	52,7	50,8	4000
1200256	-2024	20	32,0	1 1/4"	24	1 1/2	55,7	60,3	3000
1200276	-2424	24	38,0	1 1/2"	24	1 1/2	56,0	60,3	3000
1200277	-2432	24	38,0	1 1/2"	32	2	67,5	71,4	3000
1200287	-3232	32	51,0	2"	32	2	69,0	71,4	3000

// H1443340

45° Flange SAE 3000 PSI J518 Code 61 - SFL 45
Solid one piece

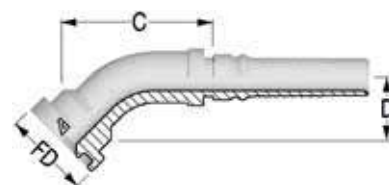

Item Code	Tail/Head	ID		Flange		Flange Size	FD	C	D Drop	WP
	Dash	Dash	mm	in	Dash Size					
1200230	-1620	16	25,0	1"	20	1 1/4	50,8	95,6	30,0	4000
1200253	-2020	20	32,0	1 1/4"	20	1 1/4	50,8	100,9	32,5	4000
1200252	-2024	20	32,0	1 1/4"	24	1 1/2	60,3	92,8	40,0	3000
1200272	-2424	24	38,0	1 1/2"	24	1 1/2	60,3	103,7	43,0	3000
1200273	-2432	24	38,0	1 1/2"	32	2	71,4	132,7	56,5	3000
1200285	-3232	32	51,0	2"	32	2	71,4	138,1	54,0	3000

// H1443390

90° Flange SAE 3000 PSI J518 Code 61 - SFL 90
Solid one piece

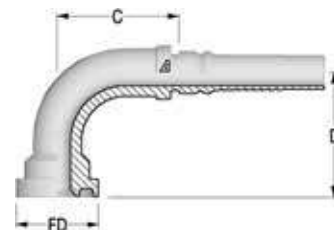

Item Code	Tail/Head	ID		Flange		Flange Size	FD	C	D Drop	WP
	Dash	Dash	mm	in	Dash Size					
1200231	-1616	16	25,0	1"	16	1	44,5	72,2	64,0	5000
1200232	-1620	16	25,0	1"	20	1 1/4	50,8	70,2	69,0	4000
1200255	-2020	20	32,0	1 1/4"	20	1 1/4	50,8	86,2	81,0	4000
1200254	-2024	20	32,0	1 1/4"	24	1 1/2	60,3	81,2	85,0	3000
1200274	-2424	24	38,0	1 1/2"	24	1 1/2	60,3	95,5	93,0	3000
1200275	-2432	24	38,0	1 1/2"	32	2	71,4	130,3	97,0	3000
1200286	-3232	32	51,0	2"	32	2	71,4	134,4	130,0	3000

Dimensions shown may be changed without prior notice

// H1443610

Flange SAE 6000 PSI J518 Code 62 - SFS

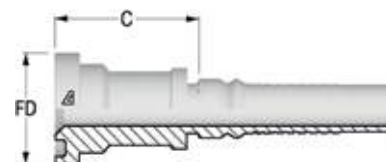

Item Code	Tail/Head	ID		Flange		C	FD	WP	
	Dash	Dash	mm	in	Dash Size				Flange Size
1200199	-1212	12	19,0	3/4"	12	3/4	50,0	41,3	6000
1200198	-1216	12	19,0	3/4"	16	1	53,0	47,6	6000
1201218	-1612	16	25,0	1"	12	3/4	51,0	41,3	6000
1200224	-1616	16	25,0	1"	16	1	54,0	47,6	6000
1200225	-1620	16	25,0	1"	20	1 1/4	61,0	54,0	6000
1201556	-2016	20	32,0	1 1/4"	16	1	80,2	47,6	6000
1200246	-2020	20	32,0	1 1/4"	20	1 1/4	62,2	54,0	6000
1200245	-2024	20	32,0	1 1/4"	24	1 1/2	68,2	63,5	6000
1200270	-2420	24	38,0	1 1/2"	20	1 1/4	62,5	54,0	6000
1200268	-2424	24	38,0	1 1/2"	24	1 1/2	68,5	63,5	6000
1200271	-2432	24	38,0	1 1/2"	32	2	80,5	79,4	6000
1200284	-3232	32	51,0	2"	32	2	87,0	79,4	6000

// H1443640

**45° Flange SAE 6000 PSI J518 Code 62 - SFS 45
Solid one piece**

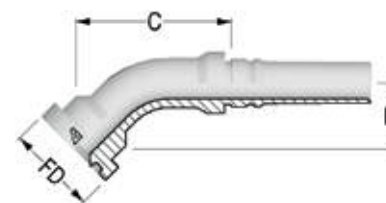

Item Code	Tail/Head	ID		Flange		FD	C	D Drop	WP	
	Dash	Dash	mm	in	Dash Size					Flange Size
1200195	-1212	12	19,0	3/4"	12	3/4	41,3	72,1	30,0	6000
1200194	-1216	12	19,0	3/4"	16	1	47,6	76,8	33,0	6000
1202890	-1612	16	25,0	1"	12	3/4	41,3	80,3	29,5	6000
1245060	-1612	16	25,0	1"	12	3/4	41,3	80,3	29,5	6000
1200220	-1616	16	25,0	1"	16	1	47,6	94,8	35,0	6000
1245059	-1616	16	25,0	1"	16	1	47,6	94,8	35,0	6000
1200221	-1620	16	25,0	1"	20	1 1/4	54,0	105,3	44,0	6000
1201557	-2016	20	32,0	1 1/4"	16	1	47,6	104,7	34,5	6000
1200242	-2020	20	32,0	1 1/4"	20	1 1/4	54,0	102,0	39,5	6000
1200241	-2024	20	32,0	1 1/4"	24	1 1/2	63,5	111,7	48,0	6000
1200264	-2424	24	38,0	1 1/2"	24	1 1/2	63,5	136,3	48,0	6000
1200265	-2432	24	38,0	1 1/2"	32	2	79,4	129,1	55,0	6000
1200282	-3232	32	51,0	2"	32	2	79,4	160,6	63,0	6000

// H1443690

90° Flange SAE 6000 PSI J518 Code 62 - SFS 90
Solid one piece

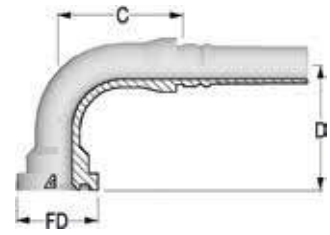

Item Code	Tail/Head	ID		Flange		Flange Size	FD	C	D Drop	WP
	Dash	Dash	mm	in	Dash Size					
1200197	-1212	12	19,0	3/4"	12	3/4	41,3	61,2	64,0	6000
1200196	-1216	12	19,0	3/4"	16	1	47,6	61,2	66,0	6000
1202811	-1612	16	25,0	1"	12	3/4	41,3	70,2	61,0	6000
1245058	-1616	16	25,0	1"	16	1	47,6	70,4	74,0	6000
1200222	-1616	16	25,0	1"	16	1	47,6	70,4	74,0	6000
1200223	-1620	16	25,0	1"	20	1 1/4	54,0	77,2	80,0	6000
1200244	-2020	20	32,0	1 1/4"	20	1 1/4	54,0	88,2	91,0	6000
1200243	-2024	20	32,0	1 1/4"	24	1 1/2	63,5	92,9	103,5	6000
1200266	-2424	24	38,0	1 1/2"	24	1 1/2	63,5	106,3	109,0	6000
1200267	-2432	24	38,0	1 1/2"	32	2	79,4	106,5	121,5	6000
1200283	-3232	32	51,0	2"	32	2	79,4	146,0	138,5	6000

Dimensions shown may be changed without prior notice

// H1T43610

**Flange SAE 6000 PSI J518 Code 62 - SFS
Special version**

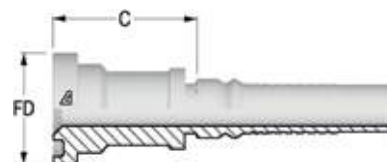

Item Code	Tail/Head	ID		Flange	Flange Size	C	FD	WP	
	Dash	Dash	mm	in		Dash Size	mm	mm	psi
1223166	-3224	32	51,0	2"	24	1 1/2	106,0	63,5	6000
1223388	-3232	32	51,0	2"	32	2	104,0	79,4	6000
1235395	-4040	40	63,0	2 1/2"	40	2 1/2	124,3	108,0	6000

// H1T43640

**45° Flange SAE 6000 PSI J518 Code 62 - SFS 45
Solid one piece
Special version**

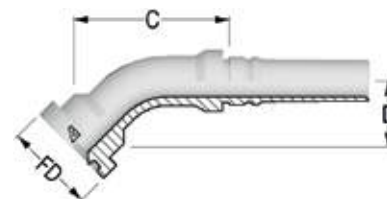

Item Code	Tail/Head	ID		Flange	Flange Size	FD	C	D Drop	WP	
	Dash	Dash	mm	in		Dash Size	mm	mm	mm	psi
1223389	-3232	32	51,0	2"	32	2	79,4	141,0	63,0	6000

// H1T43690

**90° Flange SAE 6000 PSI J518 Code 62 - SFS 90
Solid one piece
Special version**

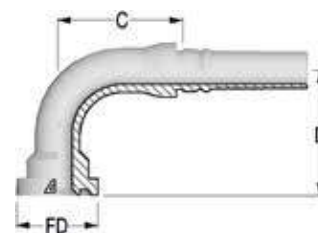

Item Code	Tail/Head	ID		Flange	Flange Size	FD	C	D Drop	WP	
	Dash	Dash	mm	in		Dash Size	mm	mm	mm	psi
1223168	-3224	32	51,0	2"	24	1 1/2	63,5	134,0	112,0	6000
1228051	-3232	32	51,0	2"	32	2	79,4	132,0	145,0	6000

// SUPERCAT FLANGES

// H1443910

Flange SUPERCAT

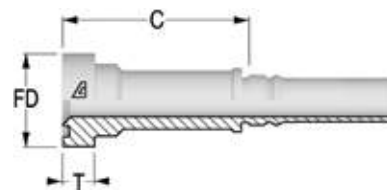

Item Code	Tail/Head	ID		Flange		Flange Size	FD	T	C
	Dash	Dash	mm	in	Dash Size				
1202219	-1212	12	19,0	3/4"	12	3/4	41,3	14,3	82,0
1202388	-1216	12	19,0	3/4"	16	1	47,6	14,3	82,0
1202389	-1616	16	25,0	1"	16	1	47,6	14,3	90,0
1202390	-1620	16	25,0	1"	20	1 1/4	54,0	14,3	90,0
1202391	-2020	20	32,0	1 1/4"	20	1 1/4	54,0	14,3	86,2
1202392	-2024	20	32,0	1 1/4"	24	1 1/2	63,5	14,3	83,2

// H1443940

45° Flange SUPERCAT Solid one piece

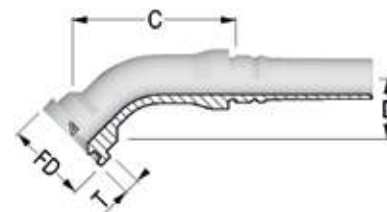

Item Code	Tail/Head	ID		Flange		Flange Size	FD	T	C	D Drop
	Dash	Dash	mm	in	Dash Size					
1202398	-1212	12	19,0	3/4"	12	3/4	41,3	14,3	82,9	34,0
1202397	-1216	12	19,0	3/4"	16	1	47,6	14,3	87,4	34,0
1202396	-1616	16	25,0	1"	16	1	47,6	14,3	93,9	40,0
1202395	-1620	16	25,0	1"	20	1 1/4	54,0	14,3	95,4	40,0
1202394	-2020	20	32,0	1 1/4"	20	1 1/4	54,0	14,3	103,6	43,0
1202393	-2024	20	32,0	1 1/4"	24	1 1/2	63,5	14,3	110,1	49,5

// H1443990

90° Flange SUPERCAT Solid one piece

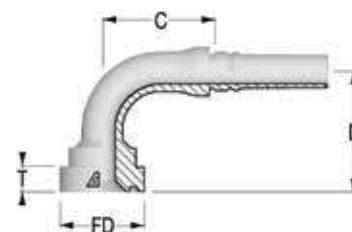

Item Code	Tail/Head	ID		Flange		Flange Size	FD	T	C	D Drop
	Dash	Dash	mm	in	Dash Size					
1202399	-1212	12	19,0	3/4"	12	3/4	41,3	14,3	63,7	67,0
1202400	-1216	12	19,0	3/4"	16	1	47,6	14,3	65,2	70,0
1202401	-1616	16	25,0	1"	16	1	47,6	14,3	80,4	79,0
1202402	-1620	16	25,0	1"	20	1 1/4	54,0	14,3	75,4	82,5
1202403	-2020	20	32,0	1 1/4"	20	1 1/4	54,0	14,3	89,2	93,0
1202404	-2024	20	32,0	1 1/4"	24	1 1/2	63,5	14,3	91,4	101,0

Dimensions shown may be changed without prior notice

// HAMMER UNION

// H1413F13

Male Hammer Union Fig. 1502 integral fitting with Lug Nut



Item Code	Tail/Head	Dash	ID		C	L
	Dash		mm	in		
1235621	-3232	32	51,0	2"	55,0	152,00

// H1423F10

Female Hammer Union Fig. 1502 integral fitting with Rubber Ring

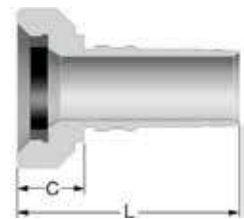

Item Code	Tail/Head	Dash	ID		C	L
	Dash		mm	in		
1238273	-3232	32	51,0	2"	51,5	148,50

// H1T13F13

Male Hammer Union Fig. 1502 integral fitting with Lug Nut
Special version



Item Code	Tail/Head	Dash	ID		C	L
	Dash		mm	in		
1235624	-3232	32	51,0	2"	60,8	162,20

// H1T23F10

Female Hammer Union Fig. 1502 integral fitting with Rubber Ring
Special version

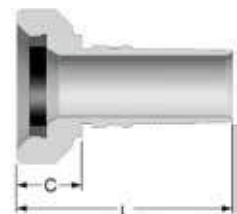

Item Code	Tail/Head	Dash	ID		C	L
	Dash		mm	in		
1235623	-3232	32	51,0	2"	57,3	158,70



// ALFACRIMP // C12A

// BSP INSERTS.....	135	// NPSM INSERTS.....	153
// DIN METRIC INSERTS.....	139	// ORFS INSERTS.....	154
// SAE INSERTS.....	144	// JIS INSERTS.....	157
// JIC 37° INSERTS.....	146	// KOMATSU INSERTS.....	158
// NPTF INSERTS.....	151	// SAE FLANGES.....	159

Dimensions shown may be changed without prior notice

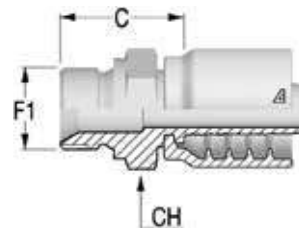
// **BSP INSERTS**// **C12A10510****BSPP Male 60° Flare
AGR**

Item Code	Tail/Head	Nut Type	ID			F1	F1	C	CH
	Dash		Dash	mm	in	Dash Size			
1232544	-0402	NA	04	6,0	1/4"	02	1/8-28	20,8	14,0
1232545	-0404	NA	04	6,0	1/4"	04	1/4-19	26,3	19,0
1232546	-0406	NA	04	6,0	1/4"	06	3/8-19	27,8	22,0
1232547	-0506	NA	05	8,0	5/16"	06	3/8-19	27,8	22,0
1232548	-0606	NA	06	10,0	3/8"	06	3/8-19	27,8	22,0
1232549	-0608	NA	06	10,0	3/8"	08	1/2-14	31,3	27,0
1232550	-0806	NA	08	13,0	1/2"	06	3/8-19	28,6	22,0
1232551	-0808	NA	08	13,0	1/2"	08	1/2-14	32,1	27,0
1232552	-0810	NA	08	13,0	1/2"	10	5/8-14	34,1	30,0
1232553	-0812	NA	08	13,0	1/2"	12	3/4-14	36,1	32,0
1232554	-1010	NA	10	16,0	5/8"	10	5/8-14	34,1	30,0
1232555	-1012	NA	10	16,0	5/8"	12	3/4-14	36,1	32,0
1232556	-1212	NA	12	19,0	3/4"	12	3/4-14	36,6	32,0
1232557	-1216	NA	12	19,0	3/4"	16	1-11	41,6	41,0
1232558	-1616	NA	16	25,0	1"	16	1-11	42,4	41,0
1232559	-1620	NA	16	25,0	1"	20	1 1/4-11	46,4	50,0

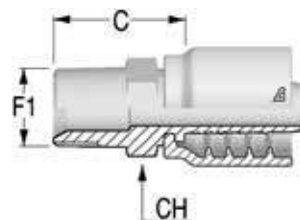
// **C12A10710****BSPT Male
AGR K**

Item Code	Tail/Head	Nut Type	ID			F1	F1	C	CH
	Dash		Dash	mm	in	Dash Size			
1232560	-0402	NA	04	6,0	1/4"	02	1/8-28	21,3	12,0
1232561	-0404	NA	04	6,0	1/4"	04	1/4-19	26,8	17,0
1232562	-0406	NA	04	6,0	1/4"	06	3/8-19	27,8	19,0
1232563	-0506	NA	05	8,0	5/16"	06	3/8-19	27,8	19,0
1232564	-0606	NA	06	10,0	3/8"	06	3/8-19	27,8	19,0
1232565	-0608	NA	06	10,0	3/8"	08	1/2-14	32,3	22,0
1232566	-0808	NA	08	13,0	1/2"	08	1/2-14	33,1	22,0
1232567	-1012	NA	10	16,0	5/8"	12	3/4-14	34,1	27,0
1232568	-1212	NA	12	19,0	3/4"	12	3/4-14	34,6	27,0
1232569	-1216	NA	12	19,0	3/4"	16	1-11	43,6	36,0
1232570	-1616	NA	16	25,0	1"	16	1-11	44,4	36,0

// C12A20813

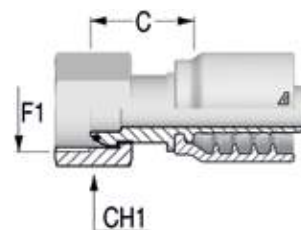
**BSP Female 60° Cone with O-Ring
DKOR**

Item Code	Tail/Head	Nut Type	ID			F1	F1	C	CH1
	Dash		Dash	mm	in	Dash Size			
1232679	-0404	SN	04	6,0	1/4"	04	1/4-19	20,8	19,0
1232680	-0406	SN	04	6,0	1/4"	06	3/8-19	23,3	22,0
1232681	-0506	SN	05	8,0	5/16"	06	3/8-19	23,3	22,0
1232675	-0604	CR	06	10,0	3/8"	04	1/4-19	17,3	19,0
1232682	-0606	SN	06	10,0	3/8"	06	3/8-19	23,3	22,0
1232683	-0608	SN	06	10,0	3/8"	08	1/2-14	24,3	27,0
1232684	-0808	SN	08	13,0	1/2"	08	1/2-14	25,1	27,0
1232685	-0810	SN	08	13,0	1/2"	10	5/8-14	28,4	27,0
1232686	-0812	SN	08	13,0	1/2"	12	3/4-14	29,0	32,0
1232676	-1010	CR	10	16,0	5/8"	10	5/8-14	17,1	27,0
1232687	-1012	SN	10	16,0	5/8"	12	3/4-14	29,0	32,0
1232677	-1212	CR	12	19,0	3/4"	12	3/4-14	20,6	32,0
1232688	-1216	SN	12	19,0	3/4"	16	1-11	34,0	38,0
1232678	-1616	CR	16	25,0	1"	16	1-11	23,9	38,0
1232689	-1620	SN	16	25,0	1"	20	1 1/4-11	39,4	50,0

// C12A20843

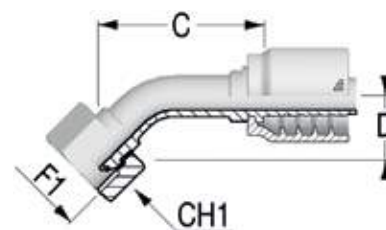
**45° BSP Female 60° Cone with O-Ring
DKOR 45
Solid one piece**

Item Code	Tail/Head	Nut Type	ID			F1	F1	C	D Drop	CH1
	Dash		Dash	mm	in	Dash Size				
1232693	-0404	SN	04	6,0	1/4"	04	1/4-19	45,5	15,0	19,0
1232694	-0406	SN	04	6,0	1/4"	06	3/8-19	41,5	17,5	22,0
1232695	-0506	SN	05	8,0	5/16"	06	3/8-19	45,1	18,5	22,0
1232696	-0606	SN	06	10,0	3/8"	06	3/8-19	49,9	20,5	22,0
1232697	-0608	SN	06	10,0	3/8"	08	1/2-14	45,7	21,0	27,0
1232698	-0808	SN	08	13,0	1/2"	08	1/2-14	55,0	21,0	27,0
1232699	-0810	SN	08	13,0	1/2"	10	5/8-14	57,2	23,0	27,0
1232700	-0812	SN	08	13,0	1/2"	12	3/4-14	56,7	23,0	32,0
1232690	-1010	CR	10	16,0	5/8"	10	5/8-14	64,0	21,5	27,0
1232701	-1012	SN	10	16,0	5/8"	12	3/4-14	66,5	22,5	32,0
1232691	-1212	CR	12	19,0	3/4"	12	3/4-14	70,0	28,0	32,0
1232702	-1216	SN	12	19,0	3/4"	16	1-11	74,6	31,5	38,0
1232692	-1616	CR	16	25,0	1"	16	1-11	84,0	34,0	38,0

Dimensions shown may be changed without prior notice

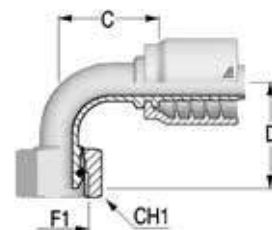
// C12A20893**90° BSPP Female 60° Cone with O-Ring****DKOR 90****Solid one piece**

Item Code	Tail/Head	Nut Type	ID			F1	F1	C	D Drop	CH1
	Dash		Dash	mm	in	Dash Size				
1232706	-0404	SN	04	6,0	1/4"	04	1/4-19	29,3	29,0	19,0
1232707	-0406	SN	04	6,0	1/4"	06	3/8-19	29,8	31,0	22,0
1232708	-0506	SN	05	8,0	5/16"	06	3/8-19	33,2	36,0	22,0
1232709	-0606	SN	06	10,0	3/8"	06	3/8-19	34,8	42,0	22,0
1232710	-0608	SN	06	10,0	3/8"	08	1/2-14	34,3	35,5	27,0
1232711	-0808	SN	08	13,0	1/2"	08	1/2-14	35,8	41,0	27,0
1232712	-0810	SN	08	13,0	1/2"	10	5/8-14	41,6	43,5	27,0
1232713	-0812	SN	08	13,0	1/2"	12	3/4-14	41,8	43,0	32,0
1232703	-1010	CR	10	16,0	5/8"	10	5/8-14	47,9	47,0	27,0
1232714	-1012	SN	10	16,0	5/8"	12	3/4-14	51,9	49,0	32,0
1232704	-1212	CR	12	19,0	3/4"	12	3/4-14	49,1	53,0	32,0
1232715	-1216	SN	12	19,0	3/4"	16	1-11	54,1	60,5	38,0
1232705	-1616	CR	16	25,0	1"	16	1-11	75,1	69,0	38,0
1232716	-1620	SN	16	25,0	1"	20	1 1/4-11	75,1	88,5	50,0

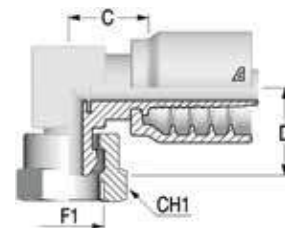
// C12A20581**90° Compact BSPP Female 60° Cone****DKR 90**

Item Code	Tail/Head	Nut Type	ID			F1	F1	C	D Drop	CH1
	Dash		Dash	mm	in	Dash Size				
1232668	-0606	CR	06	10,0	3/8"	06	3/8-19	18,8	22,0	22,0
1232669	-0808	CR	08	13,0	1/2"	08	1/2-14	22,6	24,5	27,0
1232670	-1212	CR	12	19,0	3/4"	12	3/4-14	26,7	31,0	32,0

// C12A20613

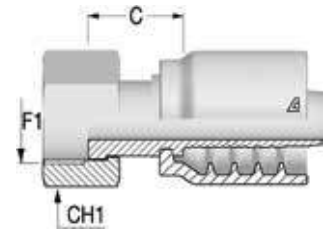
**BSP Female Flat Seat
DKR FD**

Item Code	Tail/Head	Nut Type	ID			F1	F1	C	CH1
	Dash		Dash	mm	in	Dash Size			
1232672	-0606	SN	06	10,0	3/8"	06	3/8-19	20,3	22,0
1232673	-0608	SN	06	10,0	3/8"	08	1/2-14	20,8	27,0
1232674	-0808	SN	08	13,0	1/2"	08	1/2-14	21,6	27,0
1232671	-1212	CR	12	19,0	3/4"	12	3/4-14	18,1	32,0

Dimensions shown may be changed without prior notice

// DIN METRIC INSERTS

// C12A11110

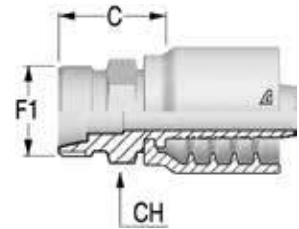
Metric Male 24° Seat - Light
DIN 3853 - CEL

Item Code	Tail/Head Dash/mm	Nut Type	ID			F1	OD1 mm	C mm	CH mm
			Dash	mm	in				
1232571	-0412	NA	04	6,0	1/4"	M12X1.5	6	21,3	14,0
1232572	-0414	NA	04	6,0	1/4"	M14X1.5	8	21,3	14,0
1232573	-0416	NA	04	6,0	1/4"	M16X1.5	10	23,3	17,0
1232574	-0516	NA	05	8,0	5/16"	M16X1.5	10	23,3	17,0
1232575	-0518	NA	05	8,0	5/16"	M18X1.5	12	24,3	19,0
1232576	-0616	NA	06	10,0	3/8"	M16X1.5	10	23,3	17,0
1232577	-0618	NA	06	10,0	3/8"	M18X1.5	12	24,3	19,0
1232578	-0622	NA	06	10,0	3/8"	M22X1.5	15	25,3	22,0
1232579	-0822	NA	08	13,0	1/2"	M22X1.5	15	26,1	22,0
1232580	-0826	NA	08	13,0	1/2"	M26X1.5	18	27,1	27,0
1232581	-1026	NA	10	16,0	5/8"	M26X1.5	18	27,1	27,0
1232582	-1230	NA	12	19,0	3/4"	M30X2	22	31,6	32,0
1232583	-1636	NA	16	25,0	1"	M36X2	28	34,4	36,0

// C12A21513

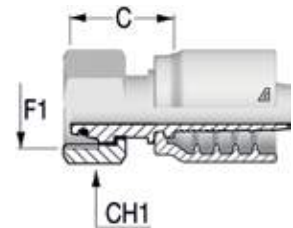
Metric Female 24° Cone with O-Ring - Light
DIN 3865 - DKOL

Item Code	Tail/Head Dash/mm	Nut Type	ID			F1	OD1 mm	C mm	CH1 mm
			Dash	mm	in				
1232717	-0412	CR	04	6,0	1/4"	M12X1.5	6	24,8	14,0
1232718	-0414	SN	04	6,0	1/4"	M14X1.5	8	24,4	17,0
1232719	-0416	SN	04	6,0	1/4"	M16X1.5	10	25,4	19,0
1232720	-0516	SN	05	8,0	5/16"	M16X1.5	10	25,4	19,0
1232721	-0616	SN	06	10,0	3/8"	M16X1.5	10	25,4	19,0
1232722	-0618	SN	06	10,0	3/8"	M18X1.5	12	25,4	22,0
1232723	-0622	SN	06	10,0	3/8"	M22X1.5	15	27,4	27,0
1232724	-0822	SN	08	13,0	1/2"	M22X1.5	15	28,2	27,0
1232725	-0826	SN	08	13,0	1/2"	M26X1.5	18	29,2	32,0
1232726	-1026	SN	10	16,0	5/8"	M26X1.5	18	29,2	32,0
1232727	-1230	SN	12	19,0	3/4"	M30X2	22	31,7	36,0
1232728	-1636	SN	16	25,0	1"	M36X2	28	33,6	41,0

// C12A21543

45° Metric Female 24° Cone with O-Ring - Light
DIN 3865 - DKOL 45
Solid one piece

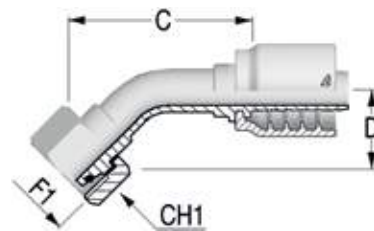

Item Code	Tail/Head Dash/mm	Nut Type	ID			F1	OD1 mm	C mm	D Drop mm	CH1 mm
			Dash	mm	in					
1232729	-0414	SN	04	6,0	1/4"	M14X1.5	8	43,0	17,5	17,0
1232730	-0416	SN	04	6,0	1/4"	M16X1.5	10	42,0	20,0	19,0
1232731	-0516	SN	05	8,0	5/16"	M16X1.5	10	47,5	20,0	19,0
1232733	-0618	SN	06	10,0	3/8"	M18X1.5	12	46,8	19,5	22,0
1232734	-0822	SN	08	13,0	1/2"	M22X1.5	15	55,0	21,0	22,0
1232735	-1026	SN	10	16,0	5/8"	M26X1.5	18	65,3	24,0	32,0
1232736	-1230	SN	12	19,0	3/4"	M30X2	22	69,4	32,0	36,0
1232737	-1636	SN	16	25,0	1"	M36X2	28	91,4	32,0	41,0

// C12A21593

90° Metric Female 24° Cone with O-Ring - Light
DIN 3865 - DKOL 90
Solid one piece

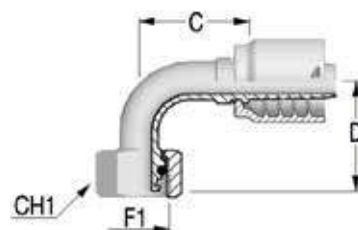

Item Code	Tail/Head Dash/mm	Nut Type	ID			F1	OD1 mm	C mm	D Drop mm	CH1 mm
			Dash	mm	in					
1232738	-0412	CR	04	6,0	1/4"	M12X1.5	6	29,5	26,0	14,0
1232739	-0414	SN	04	6,0	1/4"	M14X1.5	8	28,3	32,5	17,0
1232740	-0416	SN	04	6,0	1/4"	M16X1.5	10	28,3	32,5	19,0
1232741	-0418	SN	04	6,0	1/4"	M18X1.5	12	28,8	35,0	22,0
1232742	-0516	SN	05	8,0	5/16"	M16X1.5	10	33,7	38,0	19,0
1232743	-0616	SN	06	10,0	3/8"	M16X1.5	10	32,8	38,0	19,0
1232744	-0618	SN	06	10,0	3/8"	M18X1.5	12	32,8	39,0	22,0
1232745	-0822	SN	08	13,0	1/2"	M22X1.5	15	39,8	40,5	27,0
1232746	-1026	SN	10	16,0	5/8"	M26X1.5	18	51,4	48,0	32,0
1232747	-1030	SN	10	16,0	5/8"	M30X2	22	52,4	49,0	36,0
1232748	-1230	SN	12	19,0	3/4"	M30X2	22	52,1	59,0	36,0
1232749	-1636	SN	16	25,0	1"	M36X2	28	77,6	68,0	41,0

Dimensions shown may be changed without prior notice

// C12A11210

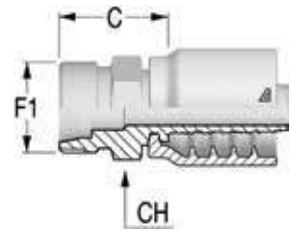
**Metric Male 24° Seat - Heavy
DIN 3853 - CES**

Item Code	Tail/Head Dash/mm	Nut Type	ID			F1	OD1 mm	C mm	CH mm
			Dash	mm	in				
1232584	-0418	NA	04	6,0	1/4"	M18X1.5	10	25,3	19,0
1232585	-0520	NA	05	8,0	5/16"	M20X1.5	12	25,3	22,0
1232586	-0620	NA	06	10,0	3/8"	M20X1.5	12	25,3	22,0
1232587	-0622	NA	06	10,0	3/8"	M22X1.5	14	27,3	22,0
1232588	-0824	NA	08	13,0	1/2"	M24X1.5	16	29,1	24,0
1232589	-1030	NA	10	16,0	5/8"	M30X2	20	33,1	32,0
1232590	-1230	NA	12	19,0	3/4"	M30X2	20	33,6	32,0
1232591	-1236	NA	12	19,0	3/4"	M36X2	25	37,6	36,0
1232592	-1642	NA	16	25,0	1"	M42X2	30	42,4	46,0

// C12A21613

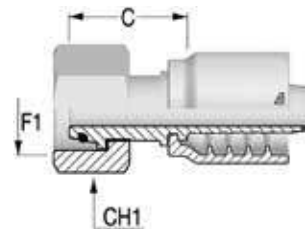
**Metric Female 24° Cone with O-Ring - Heavy
DIN 3865 - DKOS**

Item Code	Tail/Head Dash/mm	Nut Type	ID			F1	OD1 mm	C mm	CH1 mm
			Dash	mm	in				
1232750	-0416	SN	04	6,0	1/4"	M16X1.5	8	27,7	19,0
1232751	-0418	SN	04	6,0	1/4"	M18X1.5	10	27,6	22,0
1232752	-0520	SN	05	8,0	5/16"	M20X1.5	12	27,6	24,0
1232753	-0618	SN	06	10,0	3/8"	M18X1.5	10	27,6	22,0
1232754	-0620	SN	06	10,0	3/8"	M20X1.5	12	27,6	24,0
1232755	-0622	SN	06	10,0	3/8"	M22X1.5	14	31,1	27,0
1232756	-0820	SN	08	13,0	1/2"	M20X1.5	12	31,9	24,0
1232757	-0824	SN	08	13,0	1/2"	M24X1.5	16	31,7	30,0
1232758	-1030	SN	10	16,0	5/8"	M30X2	20	36,5	36,0
1232759	-1230	SN	12	19,0	3/4"	M30X2	20	37,0	36,0
1232760	-1236	SN	12	19,0	3/4"	M36X2	25	40,2	46,0
1232761	-1636	SN	16	25,0	1"	M36X2	25	41,0	46,0
1232762	-1642	SN	16	25,0	1"	M42X2	30	43,1	50,0

// C12A21643

45° Metric Female 24° Cone with O-Ring - Heavy
DIN 3865 - DKOS 45
Solid one piece

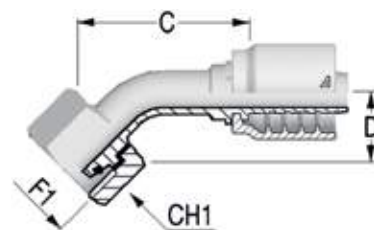

Item Code	Tail/Head Dash/mm	Nut Type	ID			F1	OD1 mm	C mm	D Drop mm	CH1 mm
			Dash	mm	in					
1232763	-0416	SN	04	6,0	1/4"	M16X1.5	8	48,6	16,0	19,0
1232764	-0418	SN	04	6,0	1/4"	M18X1.5	10	43,5	19,0	22,0
1232765	-0520	SN	05	8,0	5/16"	M20X1.5	12	48,1	21,0	24,0
1232766	-0620	SN	06	10,0	3/8"	M20X1.5	12	50,6	20,0	24,0
1232767	-0622	SN	06	10,0	3/8"	M22X1.5	14	52,9	21,0	27,0
1232768	-0824	SN	08	13,0	1/2"	M24X1.5	16	55,8	21,5	30,0
1232769	-1030	SN	10	16,0	5/8"	M30X2	20	66,3	30,0	36,0
1232770	-1236	SN	12	19,0	3/4"	M36X2	25	69,5	33,0	46,0
1232771	-1642	SN	16	25,0	1"	M42X2	30	110,3	40,5	50,0

// C12A21693

90° Metric Female 24° Cone with O-Ring - Heavy
DIN 3865 - DKOS 90
Solid one piece

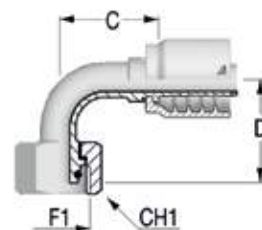

Item Code	Tail/Head Dash/mm	Nut Type	ID			F1	OD1 mm	C mm	D Drop mm	CH1 mm
			Dash	mm	in					
1232772	-0416	SN	04	6,0	1/4"	M16X1.5	8	27,3	33,0	19,0
1232773	-0418	SN	04	6,0	1/4"	M18X1.5	10	26,8	34,0	22,0
1232774	-0520	SN	05	8,0	5/16"	M20X1.5	12	33,2	39,0	24,0
1232775	-0618	TN	06	10,0	3/8"	M18X1.5	10	35,0	38,0	22,0
1232776	-0620	SN	06	10,0	3/8"	M20X1.5	12	34,3	38,5	24,0
1232777	-0622	SN	06	10,0	3/8"	M22X1.5	14	34,3	40,5	27,0
1232778	-0824	SN	08	13,0	1/2"	M24X1.5	16	39,8	41,5	30,0
1232779	-1030	SN	10	16,0	5/8"	M30X2	20	47,9	55,0	36,0
1232780	-1230	SN	12	19,0	3/4"	M30X2	20	50,6	58,0	36,0
1232781	-1236	SN	12	19,0	3/4"	M36X2	25	50,6	59,5	46,0
1232782	-1642	SN	16	25,0	1"	M42X2	30	75,6	79,0	50,0

Dimensions shown may be changed without prior notice

// C12A52010

**Metric Straight Standpipe - DIN 2353
RSL/RSS**

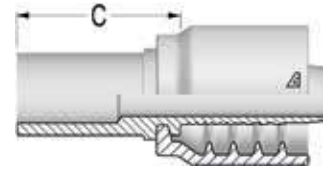

Item Code	Tail/Head	Dash	ID		OD1	C
	Dash/mm		mm	in		
1233002	-0408	04	6,0	1/4"	8	30,2
1233003	-0610	06	10,0	3/8"	10	30,3
1233004	-0815	08	13,0	1/2"	15	32,1
1233005	-0816	08	13,0	1/2"	16	37,1

// SAE INSERTS

// C12A13B10

SAE Male Flareless

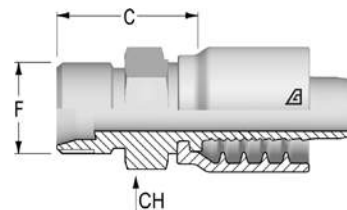

Item Code	Tail/Head	Nut Type	ID			F1	F1	C	CH
	Dash		Dash	mm	in	Dash Size			
1240072	-0404	NA	04	6,0	1/4"	04	7/16-20	21,8	12,0
1242131	-0506	NA	05	8,0	5/16"	06	9/16-18	24,2	16,0
1239967	-0606	NA	06	10,0	3/8"	06	9/16-18	24,2	16,0
1242132	-0608	NA	06	10,0	3/8"	08	3/4-16	27,6	22,0
1237777	-0808	NA	08	13,0	1/2"	08	3/4-16	28,4	22,0
1242133	-1212	NA	12	19,0	3/4"	12	1 1/16-12	33,1	30,0
1242135	-1616	NA	16	25,0	1"	16	-	37,9	36,0

// C12A26611

SAE Female Swivel 45° Seat

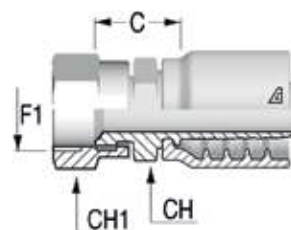

Item Code	Tail/Head	Nut Type	ID			F1	F1	C	CH	CH1
	Dash		Dash	mm	in	Dash Size				
1232955	-0606	CR	06	10,0	3/8"	06	5/8-18	23,3	19,0	22,0
1232956	-1212	CR	12	19,0	3/4"	12	1 1/16-14	28,6	27,0	32,0

Dimensions shown may be changed without prior notice

// C12A13010

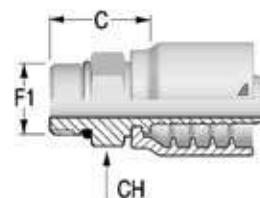
SAE Male Solid
O-Ring Boss

Item Code	Tail/Head	Nut Type	ID			F1	F1	C	CH
	Dash		Dash	mm	in	Dash Size			
1232654	-0404	NA	04	6,0	1/4"	04	7/16-20	20,3	14,0
1232655	-0405	NA	04	6,0	1/4"	05	1/2-20	21,3	16,0
1232656	-0406	NA	04	6,0	1/4"	06	9/16-18	22,3	17,0
1232657	-0606	NA	06	10,0	3/8"	06	9/16-18	23,3	19,0
1232658	-0608	NA	06	10,0	3/8"	08	3/4-16	24,3	22,0
1232659	-0610	NA	06	10,0	3/8"	10	7/8-14	26,8	27,0
1232660	-0808	NA	08	13,0	1/2"	08	3/4-16	25,1	22,0
1232661	-0810	NA	08	13,0	1/2"	10	7/8-14	27,6	27,0
1232662	-0812	NA	08	13,0	1/2"	12	1 1/16-12	32,1	32,0
1232663	-1012	NA	10	16,0	5/8"	12	1 1/16-12	32,1	32,0
1232664	-1210	NA	12	19,0	3/4"	10	7/8-14	28,1	27,0
1232665	-1212	NA	12	19,0	3/4"	12	1 1/16-12	32,6	32,0
1232666	-1216	NA	12	19,0	3/4"	16	1 5/16-12	34,6	38,0
1232667	-1616	NA	16	25,0	1"	16	1 5/16-12	35,4	38,0

// C12A13081

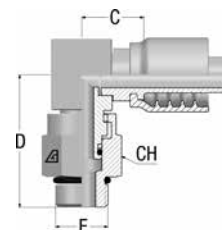
90° Compact SAE Male Swivel
O-Ring Boss

Item Code	Tale/Head	Nut Type	ID			F1	F1	C	D Drop	CH
	Dash		Dash	mm	in	Dash Size				
1240611	-0404	CR	04	6,0	1/4"	04	7/16-20	17,0	35,0	17,0
1240612	-0405	CR	04	6,0	1/4"	05	1/2-20	17,0	35,0	17,0
1240613	-0406	CR	04	6,0	1/4"	06	9/16-18	19,0	42,0	22,0
1240614	-0606	CR	06	10,0	3/8"	06	9/16-18	20,0	44,0	22,0
1240615	-0608	CR	06	10,0	3/8"	08	3/4-16	22,0	45,0	25,0
1240616	-0808	CR	08	13,0	1/2"	08	3/4-16	23,0	48,0	25,0
1240001	-0810	CR	08	13,0	1/2"	10	7/8-14	23,0	50,0	25,0
1240617	-1212	CR	12	19,0	3/4"	12	1 1/16-12	27,0	60,0	32,0
1240618	-1616	CR	16	25,0	1"	16	1 5/16-12	33,4	67,5	41,0

// JIC 37° INSERTS

// C12A12510

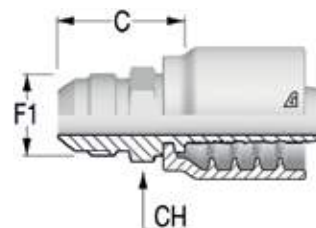
JIC Male 37° Cone
AGJ

Item Code	Tail/Head	Nut Type	ID			F1		F1	C	CH
	Dash		Dash	mm	in	Dash Size	mm			
1232606	-0404	NA	04	6,0	1/4"	04	7/16-20	25,3	12,0	
1232607	-0405	NA	04	6,0	1/4"	05	1/2-20	25,3	14,0	
1232608	-0406	NA	04	6,0	1/4"	06	9/16-18	26,3	17,0	
1232609	-0505	NA	05	8,0	5/16"	05	1/2-20	25,3	14,0	
1232610	-0506	NA	05	8,0	5/16"	06	9/16-18	26,3	17,0	
1232611	-0606	NA	06	10,0	3/8"	06	9/16-18	26,3	17,0	
1232612	-0608	NA	06	10,0	3/8"	08	3/4-16	29,8	19,0	
1232613	-0610	NA	06	10,0	3/8"	10	7/8-14	33,8	24,0	
1232614	-0808	NA	08	13,0	1/2"	08	3/4-16	30,6	19,0	
1232615	-0810	NA	08	13,0	1/2"	10	7/8-14	34,6	24,0	
1232616	-0812	NA	08	13,0	1/2"	12	1 1/16-12	37,1	27,0	
1232617	-1010	NA	10	16,0	5/8"	10	7/8-14	34,6	24,0	
1232618	-1012	NA	10	16,0	5/8"	12	1 1/16-12	37,1	27,0	
1232619	-1212	NA	12	19,0	3/4"	12	1 1/16-12	37,6	27,0	
1232620	-1214	NA	12	19,0	3/4"	14	1 3/16-12	40,1	32,0	
1232621	-1216	NA	12	19,0	3/4"	16	1 5/16-12	42,6	36,0	
1232622	-1616	NA	16	25,0	1"	16	1 5/16-12	43,4	36,0	
1232623	-1620	NA	16	25,0	1"	20	1 5/8-12	46,9	46,0	

Dimensions shown may be changed without prior notice

// C12A22511

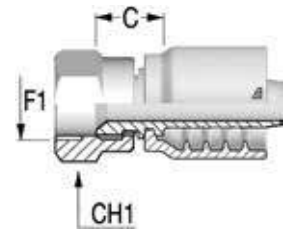
**JIC Female 37° Seat
DKJ**

Item Code	Tail/Head	Nut Type	ID			F1	F1	C	CH1
	Dash		Dash	mm	in	Dash Size			
1232848	-0404	CR	04	6,0	1/4"	04	7/16-20	14,6	16,0
1232849	-0405	CR	04	6,0	1/4"	05	1/2-20	15,3	17,0
1232850	-0406	CR	04	6,0	1/4"	06	9/16-18	15,3	19,0
1232851	-0505	CR	05	8,0	5/16"	05	1/2-20	15,3	17,0
1232852	-0506	CR	05	8,0	5/16"	06	9/16-18	15,3	19,0
1232853	-0606	CR	06	10,0	3/8"	06	9/16-18	15,3	19,0
1232854	-0608	CR	06	10,0	3/8"	08	3/4-16	17,8	25,0
1232855	-0808	CR	08	13,0	1/2"	08	3/4-16	18,6	25,0
1232856	-0810	CR	08	13,0	1/2"	10	7/8-14	19,6	27,0
1232857	-0812	CR	08	13,0	1/2"	12	1 1/16-12	22,1	32,0
1232858	-1010	CR	10	16,0	5/8"	10	7/8-14	19,6	27,0
1232859	-1012	CR	10	16,0	5/8"	12	1 1/16-12	20,1	32,0
1232860	-1210	CR	12	19,0	3/4"	10	7/8-14	20,1	27,0
1232861	-1212	CR	12	19,0	3/4"	12	1 1/16-12	20,6	32,0
1232862	-1214	CR	12	19,0	3/4"	14	1 3/16-12	19,9	36,0
1232863	-1216	CR	12	19,0	3/4"	16	1 5/16-12	22,1	38,0
1232864	-1616	CR	16	25,0	1"	16	1 5/16-12	23,9	38,0
1232865	-1620	TN	16	25,0	1"	20	1 5/8-12	26,5	50,0

// C12A26511

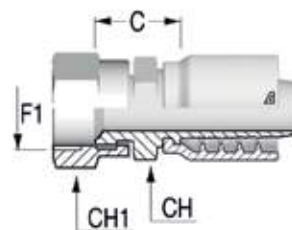
**JIC Female 37° Seat with Stem Hexagon
DKJ**

Item Code	Tail/Head	Nut Type	ID			F1		F1	C	CH	CH1
	Dash		Dash	mm	in	Dash Size	mm				
1232933	-0404	CR	04	6,0	1/4"	04	7/16-20	19,6	14,0	16,0	
1232934	-0405	CR	04	6,0	1/4"	05	1/2-20	20,3	14,0	17,0	
1232935	-0406	CR	04	6,0	1/4"	06	9/16-18	20,3	14,0	19,0	
1232936	-0506	CR	05	8,0	5/16"	06	9/16-18	20,3	14,0	19,0	
1232937	-0604	CR	06	10,0	3/8"	04	7/16-20	20,6	17,0	16,0	
1232938	-0606	CR	06	10,0	3/8"	06	9/16-18	21,3	17,0	19,0	
1232939	-0608	CR	06	10,0	3/8"	08	3/4-16	24,8	19,0	25,0	
1232940	-0610	CR	06	10,0	3/8"	10	7/8-14	25,8	22,0	27,0	
1232941	-0806	CR	08	13,0	1/2"	06	9/16-18	23,1	19,0	19,0	
1232942	-0808	CR	08	13,0	1/2"	08	3/4-16	25,6	19,0	25,0	
1232943	-0810	CR	08	13,0	1/2"	10	7/8-14	26,6	22,0	27,0	
1232944	-0812	CR	08	13,0	1/2"	12	1 1/16-12	28,1	25,0	32,0	
1232945	-1008	CR	10	16,0	5/8"	08	3/4-16	26,6	24,0	25,0	
1232946	-1010	CR	10	16,0	5/8"	10	7/8-14	27,6	24,0	27,0	
1232947	-1012	CR	10	16,0	5/8"	12	1 1/16-12	28,1	25,0	32,0	
1232948	-1210	CR	12	19,0	3/4"	10	7/8-14	28,1	27,0	27,0	
1232949	-1212	CR	12	19,0	3/4"	12	1 1/16-12	28,6	27,0	32,0	
1232950	-1214	CR	12	19,0	3/4"	14	1 3/16-12	29,9	32,0	36,0	
1232951	-1216	CR	12	19,0	3/4"	16	1 5/16-12	32,1	32,0	38,0	
1232952	-1612	CR	16	25,0	1"	12	1 1/16-12	31,4	32,0	32,0	
1232953	-1616	CR	16	25,0	1"	16	1 5/16-12	32,9	32,0	38,0	
1232954	-1620	TN	16	25,0	1"	20	1 5/8-12	37,5	41,0	50,0	

// C12A22541-M

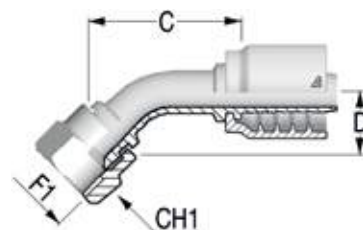
**45° JIC Female 37° Seat - Medium Drop
DKJ 45M
Solid one piece**

Item Code	Tail/Head	Nut Type	ID			F1		F1	C	D Drop	CH1
	Dash		Dash	mm	in	Dash Size	mm				
1232866	-0404	CR	04	6,0	1/4"	04	7/16-20	36,6	10,0	16,0	
1232867	-0405	CR	04	6,0	1/4"	05	1/2-20	37,2	12,0	17,0	
1232868	-0406	CR	04	6,0	1/4"	06	9/16-18	39,4	11,0	19,0	
1232869	-0506	CR	05	8,0	5/16"	06	9/16-18	42,8	12,0	19,0	
1232870	-0606	CR	06	10,0	3/8"	06	9/16-18	46,3	11,0	19,0	
1232871	-0608	CR	06	10,0	3/8"	08	3/4-16	47,2	15,0	25,0	
1232872	-0808	CR	08	13,0	1/2"	08	3/4-16	51,6	15,0	25,0	
1232873	-0810	CR	08	13,0	1/2"	10	7/8-14	50,7	16,0	27,0	
1232874	-0812	CR	08	13,0	1/2"	12	1 1/16-12	57,0	21,0	32,0	
1232875	-1010	CR	10	16,0	5/8"	10	7/8-14	62,2	19,0	27,0	
1232876	-1012	CR	10	16,0	5/8"	12	1 1/16-12	68,6	21,0	32,0	
1232877	-1212	CR	12	19,0	3/4"	12	1 1/16-12	67,5	21,0	32,0	
1232878	-1216	CR	12	19,0	3/4"	16	1 5/16-12	71,4	26,0	38,0	
1232879	-1616	CR	16	25,0	1"	16	1 5/16-12	79,4	24,0	38,0	
1232880	-1620	TN	16	25,0	1"	20	1 5/8-12	83,8	37,0	50,0	

Dimensions shown may be changed without prior notice

// C12A22591-S

90° JIC Female 37° Seat - Short Drop
DKJ 90S
Solid one piece

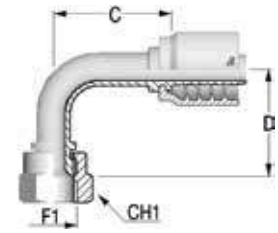

Item Code	Tail/Head	Nut Type	ID			F1	F1	C	D Drop	CH1
	Dash		Dash	mm	in	Dash Size				
1232883	-0404	CR	04	6,0	1/4"	04	7/16-20	27,0	21,0	16,0
1232885	-0405	CR	04	6,0	1/4"	05	1/2-20	26,5	23,5	17,0
1232887	-0406	CR	04	6,0	1/4"	06	9/16-18	31,0	23,0	19,0
1232892	-0606	CR	06	10,0	3/8"	06	9/16-18	42,3	23,0	19,0
1232895	-0608	CR	06	10,0	3/8"	08	3/4-16	48,8	29,0	25,0
1232898	-0808	CR	08	13,0	1/2"	08	3/4-16	46,4	29,0	25,0
1232901	-0810	CR	08	13,0	1/2"	10	7/8-14	45,8	32,0	27,0
1232903	-0812	CR	08	13,0	1/2"	12	1 1/16-12	37,3	46,0	32,0
1232907	-1012	CR	10	16,0	5/8"	12	1 1/16-12	47,9	48,0	32,0
1232910	-1212	CR	12	19,0	3/4"	12	1 1/16-12	58,2	46,0	32,0
1232912	-1216	CR	12	19,0	3/4"	16	1 5/16-12	53,6	53,0	38,0
1232915	-1616	CR	16	25,0	1"	16	1 5/16-12	74,0	56,0	38,0

// C12A22591-M

90° JIC Female 37° Seat - Medium Drop
DKJ 90M
Solid one piece

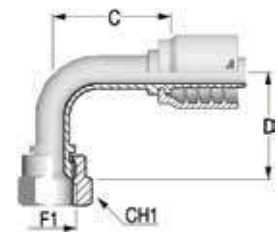

Item Code	Tail/Head	Nut Type	ID			F1	F1	C	D Drop	CH1
	Dash		Dash	mm	in	Dash Size				
1232882	-0404	CR	04	6,0	1/4"	04	7/16-20	34,2	32,0	16,0
1232884	-0405	CR	04	6,0	1/4"	05	1/2-20	25,7	30,0	17,0
1232886	-0406	CR	04	6,0	1/4"	06	9/16-18	28,5	38,0	19,0
1232888	-0505	CR	05	8,0	5/16"	05	1/2-20	34,2	32,0	17,0
1232889	-0506	CR	05	8,0	5/16"	06	9/16-18	33,2	35,0	19,0
1232891	-0606	CR	06	10,0	3/8"	06	9/16-18	31,3	35,0	19,0
1232894	-0608	CR	06	10,0	3/8"	08	3/4-16	39,5	41,0	25,0
1232897	-0808	CR	08	13,0	1/2"	08	3/4-16	37,2	40,0	25,0
1232900	-0810	CR	08	13,0	1/2"	10	7/8-14	43,3	47,0	27,0
1232902	-0812	CR	08	13,0	1/2"	12	1 1/16-12	42,8	58,0	32,0
1232905	-1010	CR	10	16,0	5/8"	10	7/8-14	49,4	48,0	27,0
1232906	-1012	CR	10	16,0	5/8"	12	1 1/16-12	47,9	58,0	32,0
1232909	-1212	CR	12	19,0	3/4"	12	1 1/16-12	52,4	54,0	32,0
1232911	-1216	CR	12	19,0	3/4"	16	1 5/16-12	52,6	72,0	38,0
1232914	-1616	CR	16	25,0	1"	16	1 5/16-12	72,6	71,5	38,0
1232916	-1620	TN	16	25,0	1"	20	1 5/8-12	72,6	78,0	50,0

// C12A22591-L

90° JIC Female 37° Seat - Long Drop
 DKJ 90L
 Solid one piece

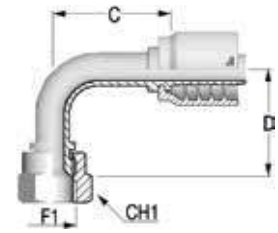

Item Code	Tail/Head	Nut Type	ID			F1	F1	C	D Drop	CH1
	Dash		Dash	mm	in	Dash Size				
1232881	-0404	CR	04	6,0	1/4"	04	7/16-20	30,8	46,0	16,0
1232890	-0606	CR	06	10,0	3/8"	06	9/16-18	43,3	54,0	19,0
1232893	-0608	CR	06	10,0	3/8"	08	3/4-16	46,8	64,0	25,0
1232896	-0808	CR	08	13,0	1/2"	08	3/4-16	49,9	64,0	25,0
1232899	-0810	CR	08	13,0	1/2"	10	7/8-14	37,3	65,0	27,0
1232904	-1010	CR	10	16,0	5/8"	10	7/8-14	49,9	65,0	27,0
1232908	-1212	CR	12	19,0	3/4"	12	1 1/16-12	54,1	95,0	32,0
1232913	-1616	CR	16	25,0	1"	16	1 5/16-12	78,6	114,0	38,0

Dimensions shown may be changed without prior notice

// NPTF INSERTS

// C12A12810

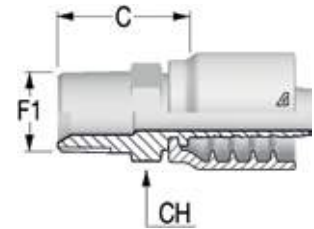
NPTF Male 60° Seat
AGN

Item Code	Tail/Head	Nut Type	ID			F1	F1	C	CH
	Dash		Dash	mm	in	Dash Size			
1232624	-0402	NA	04	6,0	1/4"	02	1/8-27	21,3	14,0
1232650	-0404	NA	04	6,0	1/4"	04	1/4-18	26,8	14,3
1232625	-0406	NA	04	6,0	1/4"	06	3/8-18	27,8	17,0
1232626	-0408	NA	04	6,0	1/4"	08	1/2-14	31,3	22,0
1232627	-0504	NA	05	8,0	5/16"	04	1/4-18	26,8	19,0
1232628	-0506	NA	05	8,0	5/16"	06	3/8-18	27,8	22,0
1232629	-0604	NA	06	10,0	3/8"	04	1/4-18	26,8	17,0
1232630	-0606	NA	06	10,0	3/8"	06	3/8-18	27,8	19,0
1232631	-0608	NA	06	10,0	3/8"	08	1/2-14	31,3	22,0
1232632	-0806	NA	08	13,0	1/2"	06	3/8-18	28,6	17,0
1232633	-0808	NA	08	13,0	1/2"	08	1/2-14	32,1	19,0
1232634	-0812	NA	08	13,0	1/2"	12	3/4-14	34,1	22,0
1232635	-1008	NA	10	16,0	5/8"	08	1/2-14	33,1	22,0
1232636	-1012	NA	10	16,0	5/8"	12	3/4-14	34,1	25,0
1232637	-1208	NA	12	19,0	3/4"	08	1/2-14	33,6	19,0
1232638	-1212	NA	12	19,0	3/4"	12	3/4-14	34,6	22,0
1232639	-1216	NA	12	19,0	3/4"	16	1-11 1/2	43,6	22,0
1232640	-1616	NA	16	25,0	1"	16	1-11 1/2	44,4	25,0
1232641	-1620	NA	16	25,0	1"	20	1 1/4-11 1/2	47,4	27,0

// C12A22810

NPTF Female Solid

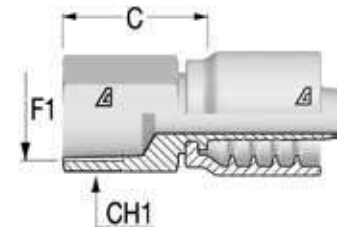

Item Code	Tail/Head	Nut Type	ID			F1	F1	C	CH
	Dash		Dash	mm	in	Dash Size			
1232917	-0404	NA	04	6,0	1/4"	04	1/4-18	27,8	19,0
1232918	-0606	NA	06	10,0	3/8"	06	3/8-18	28,8	22,0
1232919	-0808	NA	08	13,0	1/2"	08	1/2-14	35,6	25,0
1232920	-1212	NA	12	19,0	3/4"	12	3/4-14	38,1	32,0
1232921	-1616	NA	16	25,0	1"	16	1-11 1/2	44,9	38,0

// C12A12811

NPTF Male Swivel 60° Seat

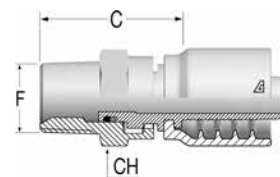

Item Code	Tail/Head	Nut Type	ID			F1	F1	C	CH
	Dash		Dash	mm	in	Dash Size			
1232642	-0404	NA	04	6,0	1/4"	04	1/4-18	37,6	24,0
1232643	-0604	NA	06	10,0	3/8"	04	1/4-18	39,6	27,0
1232644	-0606	NA	06	10,0	3/8"	06	3/8-18	37,5	27,0
1232645	-0608	CR	06	10,0	3/8"	08	1/2-14	43,5	32,0
1232646	-0806	NA	08	13,0	1/2"	06	3/8-18	38,3	36,0
1232647	-0808	NA	08	13,0	1/2"	08	1/2-14	42,3	36,0
1232648	-1212	CR	12	19,0	3/4"	12	3/4-14	50,1	41,0
1232649	-1616	NA	16	25,0	1"	16	1-11 1/2	57,9	41,0

// C12A12881

90° Compact NPTF Male Swivel 60° Seat

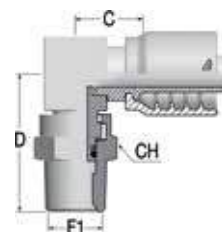

Item Code	Tail/Head	Nut Type	ID			F1	F1	C	D Drop	CH
	Dash		Dash	mm	in	Dash Size				
1232651	-0404	CR	04	6,0	1/4"	04	1/4-18	17,0	39,0	17,0
1232652	-0606	CR	06	10,0	3/8"	06	3/8-18	20,0	41,0	22,0
1232653	-0808	CR	08	13,0	1/2"	08	1/2-14	23,0	48,0	22,0

Dimensions shown may be changed without prior notice

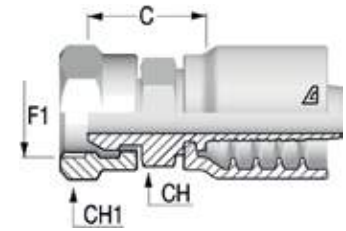
// NPSM INSERTS**// C12A27311****NPSM Female**

Item Code	Tail/Head Dash	Nut Type	ID			F1		C	CH	CH1
			Dash	mm	in	Dash Size	F1			
1232957	-0404	CR	04	6,0	1/4"	04	1/4-18	24,3	19,0	19,0
1232958	-0606	CR	06	10,0	3/8"	06	3/8-18	24,8	22,0	22,0
1232959	-0808	CR	08	13,0	1/2"	08	1/2-14	26,6	22,0	27,0
1232960	-1212	CR	12	19,0	3/4"	12	3/4-14	28,6	32,0	32,0
1232961	-1616	CR	16	25,0	1"	16	1-11 1/2	35,4	36,0	38,0

// ORFS INSERTS

// C12A12410

ORFS Male

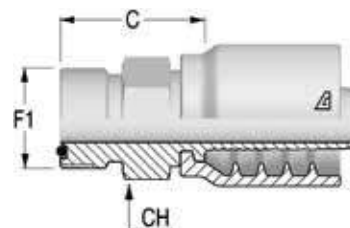

Item Code	Tail/Head	Nut Type	ID			F1	F1	C	CH
	Dash		Dash	mm	in	Dash Size			
1232593	-0404	NA	04	6,0	1/4"	04	9/16-18	22,3	17,0
1232594	-0406	NA	04	6,0	1/4"	06	11/16-16	24,3	19,0
1232595	-0606	NA	06	10,0	3/8"	06	11/16-16	24,3	19,0
1232596	-0608	NA	06	10,0	3/8"	08	13/16-16	26,3	22,0
1232597	-0610	NA	06	10,0	3/8"	10	1-14	29,8	27,0
1232598	-0808	NA	08	13,0	1/2"	08	13/16-16	27,1	22,0
1232599	-0810	NA	08	13,0	1/2"	10	1-14	30,6	27,0
1232600	-0812	NA	08	13,0	1/2"	12	1 3/16-12	34,1	32,0
1232601	-1010	NA	10	16,0	5/8"	10	1-14	30,6	27,0
1232602	-1012	NA	10	16,0	5/8"	12	1 3/16-12	34,1	32,0
1232603	-1212	NA	12	19,0	3/4"	12	1 3/16-12	34,6	32,0
1232604	-1216	NA	12	19,0	3/4"	16	1 7/16-12	38,1	41,0
1232605	-1616	NA	16	25,0	1"	16	1 7/16-12	37,9	38,0

// C12A22411

ORFS Female with Stem Hexagon

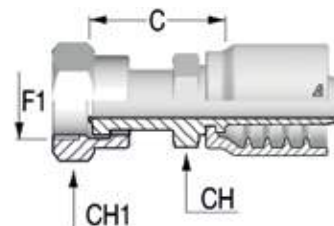

Item Code	Tail/Head	Nut Type	ID			F1	F1	C	CH	CH1
	Dash		Dash	mm	in	Dash Size				
1232783	-0404	CR	04	6,0	1/4"	04	9/16-18	27,3	14,0	17,0
1232784	-0406	CR	04	6,0	1/4"	06	11/16-16	30,3	17,0	22,0
1232785	-0408	CR	04	6,0	1/4"	08	13/16-16	35,3	22,0	24,0
1232786	-0506	CR	05	8,0	5/16"	06	11/16-16	30,3	17,0	22,0
1232787	-0606	CR	06	10,0	3/8"	06	11/16-16	30,3	17,0	22,0
1232788	-0608	CR	06	10,0	3/8"	08	13/16-16	35,3	22,0	24,0
1232789	-0806	CR	08	13,0	1/2"	06	11/16-16	32,1	19,0	22,0
1232790	-0808	CR	08	13,0	1/2"	08	13/16-16	36,1	22,0	24,0
1232791	-0810	CR	08	13,0	1/2"	10	1-14	39,6	24,0	30,0
1232792	-0812	CR	08	13,0	1/2"	12	1 3/16-12	42,1	30,0	36,0
1232793	-1010	CR	10	16,0	5/8"	10	1-14	39,6	24,0	30,0
1232794	-1012	CR	10	16,0	5/8"	12	1 3/16-12	42,1	30,0	36,0
1232795	-1210	CR	12	19,0	3/4"	10	1-14	40,1	27,0	30,0
1232796	-1212	CR	12	19,0	3/4"	12	1 3/16-12	42,6	30,0	36,0
1232797	-1216	CR	12	19,0	3/4"	16	1 7/16-12	48,6	36,0	41,0
1232798	-1612	CR	16	25,0	1"	12	1 3/16-12	45,4	32,0	36,0
1232799	-1616	CR	16	25,0	1"	16	1 7/16-12	49,4	36,0	41,0
1232800	-1620	CR	16	25,0	1"	20	1 11/16-12	50,4	41,0	50,0

Dimensions shown may be changed without prior notice

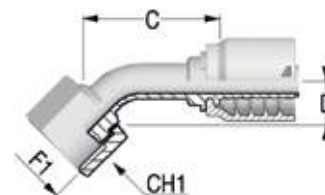
// C12A22443-M**45° ORFS Female - Medium Drop****DK ORFS 45M****Solid one piece**

Item Code	Tail/Head	Nut Type	ID			F1	F1	C	D Drop	CH1
	Dash		Dash	mm	in	Dash Size				
1232802	-0404	SN	04	6,0	1/4"	04	9/16-18	41,1	11,0	17,0
1232803	-0406	SN	04	6,0	1/4"	06	11/16-16	46,1	11,0	22,0
1232804	-0506	SN	05	8,0	5/16"	06	11/16-16	46,3	12,0	22,0
1232805	-0606	SN	06	10,0	3/8"	06	11/16-16	47,4	12,0	22,0
1232806	-0608	SN	06	10,0	3/8"	08	13/16-16	51,2	15,0	24,0
1232801	-0808	CR	08	13,0	1/2"	08	13/16-16	47,1	16,0	24,0
1232807	-0810	SN	08	13,0	1/2"	10	1-14	50,4	16,5	30,0
1232808	-1010	SN	10	16,0	5/8"	10	1-14	57,7	17,0	30,0
1232809	-1012	SN	10	16,0	5/8"	12	1 3/16-12	63,1	21,0	36,0
1232810	-1212	SN	12	19,0	3/4"	12	1 3/16-12	63,5	21,0	36,0
1232811	-1216	SN	12	19,0	3/4"	16	1 7/16-12	70,7	24,0	41,0
1232812	-1616	SN	16	25,0	1"	16	1 7/16-12	82,4	26,0	41,0
1232813	-1620	SN	16	25,0	1"	20	1 11/16-12	85,4	26,0	50,0

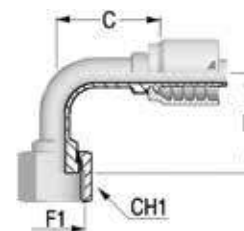
// C12A22493-S**90° ORFS Female - Short Drop****DK ORFS 90S****Solid one piece**

Item Code	Tail/Head	Nut Type	ID			F1	F1	C	D Drop	CH1
	Dash		Dash	mm	in	Dash Size				
1232819	-0404	SN	04	6,0	1/4"	04	9/16-18	28,5	21,0	17,0
1232822	-0406	SN	04	6,0	1/4"	06	11/16-16	32,0	23,0	22,0
1232826	-0606	SN	06	10,0	3/8"	06	11/16-16	41,8	25,0	22,0
1232829	-0608	SN	06	10,0	3/8"	08	13/16-16	41,8	29,0	24,0
1232816	-0808	CR	08	13,0	1/2"	08	13/16-16	39,8	29,0	24,0
1232832	-0810	SN	08	13,0	1/2"	10	1-14	46,3	32,5	30,0
1232835	-1010	SN	10	16,0	5/8"	10	1-14	52,3	32,5	30,0
1232837	-1012	SN	10	16,0	5/8"	12	1 3/16-12	55,4	49,0	36,0
1232840	-1212	SN	12	19,0	3/4"	12	1 3/16-12	60,6	51,0	36,0
1232842	-1216	SN	12	19,0	3/4"	16	1 7/16-12	61,6	56,0	41,0
1232845	-1616	SN	16	25,0	1"	16	1 7/16-12	80,0	58,0	41,0
1232847	-1620	SN	16	25,0	1"	20	1 11/16-12	82,6	64,0	50,0

// C12A22493-M

90° ORFS Female - Medium Drop

DK ORFS 90M

Solid one piece

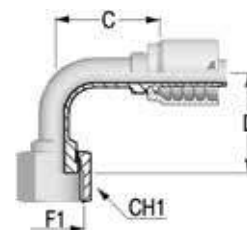

Item Code	Tail/Head	Nut Type	ID			F1	F1	C	D Drop	CH1
	Dash		Dash	mm	in	Dash Size				
1232818	-0404	SN	04	6,0	1/4"	04	9/16-18	29,8	32,0	17,0
1232821	-0406	SN	04	6,0	1/4"	06	11/16-16	37,3	38,0	22,0
1232823	-0506	SN	05	8,0	5/16"	06	11/16-16	40,7	34,0	22,0
1232825	-0606	SN	06	10,0	3/8"	06	11/16-16	41,8	38,0	22,0
1232828	-0608	SN	06	10,0	3/8"	08	13/16-16	43,8	41,0	24,0
1232815	-0808	CR	08	13,0	1/2"	08	13/16-16	34,8	42,0	24,0
1232831	-0810	SN	08	13,0	1/2"	10	1-14	48,3	47,0	30,0
1232834	-1010	SN	10	16,0	5/8"	10	1-14	55,4	44,0	30,0
1232836	-1012	SN	10	16,0	5/8"	12	1 3/16-12	55,4	58,0	36,0
1232839	-1212	SN	12	19,0	3/4"	12	1 3/16-12	61,6	58,0	36,0
1232841	-1216	SN	12	19,0	3/4"	16	1 7/16-12	65,6	71,0	41,0
1232844	-1616	SN	16	25,0	1"	16	1 7/16-12	82,6	66,0	41,0
1232846	-1620	SN	16	25,0	1"	20	1 11/16-12	82,6	78,0	50,0

// C12A22493-L

90° ORFS Female - Long Drop

DK ORFS 90L

Solid one piece

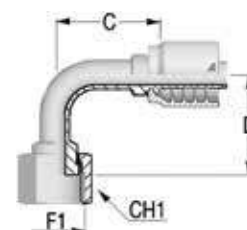

Item Code	Tail/Head	Nut Type	ID			F1	F1	C	D Drop	CH1
	Dash		Dash	mm	in	Dash Size				
1232817	-0404	CR	04	6,0	1/4"	04	9/16-18	32,8	46,0	24,0
1232820	-0406	SN	04	6,0	1/4"	06	11/16-16	34,8	54,0	30,0
1232824	-0606	SN	06	10,0	3/8"	06	11/16-16	41,8	54,0	30,0
1232827	-0608	SN	06	10,0	3/8"	08	13/16-16	46,8	64,0	30,0
1232814	-0808	CR	08	13,0	1/2"	08	13/16-16	38,3	64,0	30,0
1232830	-0810	SN	08	13,0	1/2"	10	1-14	46,3	70,0	36,0
1232833	-1010	SN	10	16,0	5/8"	10	1-14	55,4	70,0	36,0
1232838	-1212	SN	12	19,0	3/4"	12	1 3/16-12	61,6	96,0	41,0
1232843	-1616	SN	16	25,0	1"	16	1 7/16-12	82,6	114,0	41,0

Dimensions shown may be changed without prior notice

// JIS INSERTS

// C12A2381Z

JIS Female 60° Seat Flare - B 8363 (type F)

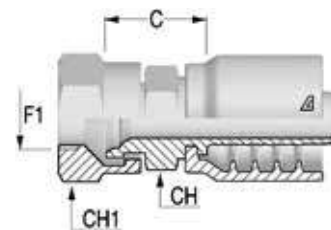

Item Code	Tail/Head Dash	Nut Type	ID			F1		C mm	CH mm	CH1 mm
			Dash	mm	in	Dash Size	F1			
1232922	-0404	CR	04	6,0	1/4"	04	1/4-19	20,8	17,0	19,0
1232923	-0606	CR	06	10,0	3/8"	06	3/8-19	21,8	19,0	22,0
1232924	-0808	CR	08	13,0	1/2"	08	1/2-14	23,6	22,0	27,0
1232925	-1212	CR	12	19,0	3/4"	12	3/4-14	27,1	30,0	36,0
1232926	-1616	CR	16	25,0	1"	16	1-11	32,9	36,0	41,0

// KOMATSU INSERTS

// C12A24011

Komatsu Female

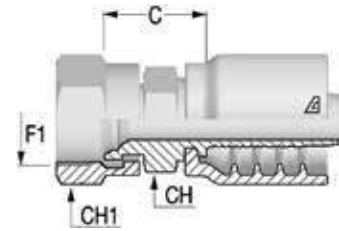

Item Code	Tail/Head Dash	Nut Type	ID			F1		F1	C	CH	CH1
			Dash	mm	in	Dash Size	mm				
1232927	-0414	CR	04	6,0	1/4"	14	M14X1.5	20,8	17,0	19,0	
1232928	-0618	CR	06	10,0	3/8"	18	M18X1.5	21,8	19,0	22,0	
1232929	-0822	CR	08	13,0	1/2"	22	M22X1.5	23,6	22,0	27,0	
1232930	-1024	CR	10	16,0	5/8"	24	M24X1.5	27,1	32,0	32,0	
1232931	-1230	CR	12	19,0	3/4"	30	M30X1.5	27,6	30,0	36,0	
1232932	-1633	CR	16	25,0	1"	33	M33X1.5	35,7	41,0	41,0	

Dimensions shown may be changed without prior notice

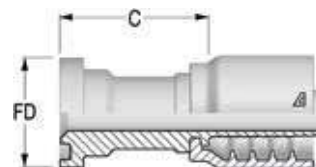
// SAE FLANGES**// C12A43310****Flange SAE 3000 PSI J518 Code 61 - SFL**

Item Code	Tail/Head	ID		Flange		C	FD	WP	
	Dash	Dash	mm	in	Dash Size				Flange Size
1232962	-0808	08	13,0	1/2"	08	1/2	41,0	30,2	5000
1232963	-0812	08	13,0	1/2"	12	3/4	42,0	38,1	5000
1232964	-1212	12	19,0	3/4"	12	3/4	42,5	38,1	5000
1232965	-1216	12	19,0	3/4"	16	1	50,5	44,5	5000
1232966	-1616	16	25,0	1"	16	1	51,4	44,5	5000
1232967	-1620	16	25,0	1"	20	1 1/4	53,9	50,8	4000

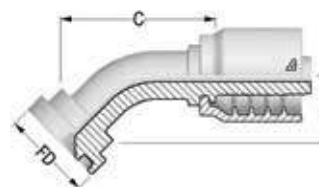
// C12A43340**45° Flange SAE 3000 PSI J518 Code 61 - SFL 45
Solid one piece**

Item Code	Tail/Head	ID		Flange		FD	C	D Drop	WP	
	Dash	Dash	mm	in	Dash Size					Flange Size
1232968	-0808	08	13,0	1/2"	08	1/2	30,2	52,9	22,0	5000
1232969	-0812	08	13,0	1/2"	12	3/4	38,1	60,3	26,0	5000
1232970	-1012	10	16,0	5/8"	12	3/4	38,1	65,0	26,0	5000
1232971	-1212	12	19,0	3/4"	12	3/4	38,1	73,7	32,0	5000
1232972	-1216	12	19,0	3/4"	16	1	44,5	77,9	29,0	5000
1232973	-1616	16	25,0	1"	16	1	44,5	82,7	33,5	5000
1232974	-1620	16	25,0	1"	20	1 1/4	50,8	82,2	36,0	4000

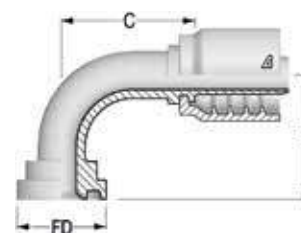
// C12A43390**90° Flange SAE 3000 PSI J518 Code 61 - SFL 90
Solid one piece**

Item Code	Tail/Head	ID		Flange		FD	C	D Drop	WP	
	Dash	Dash	mm	in	Dash Size					Flange Size
1232975	-0808	08	13,0	1/2"	08	1/2	30,2	45,8	42,0	5000
1232976	-0812	08	13,0	1/2"	12	3/4	38,1	45,3	51,0	5000
1232977	-1212	12	19,0	3/4"	12	3/4	38,1	59,7	58,0	5000
1232978	-1216	12	19,0	3/4"	16	1	44,5	66,2	64,5	5000
1232979	-1616	16	25,0	1"	16	1	44,5	70,6	67,0	5000
1232980	-1620	16	25,0	1"	20	1 1/4	50,8	73,6	71,0	4000
1232981	-1624	16	25,0	1"	24	1 1/2	60,3	93,1	75,0	3000

// C12A43610

Flange SAE 6000 PSI J518 Code 62 - SFS

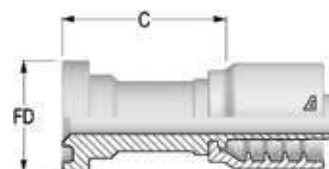

Item Code	Tail/Head	ID		Flange		Flange Size	C	FD	WP
	Dash	Dash	mm	in	Dash Size				
1232982	-0808	08	13,0	1/2"	08	1/2	47,0	31,8	6000
1232983	-0812	08	13,0	1/2"	12	3/4	52,0	41,3	6000
1232984	-1212	12	19,0	3/4"	12	3/4	52,5	41,3	6000
1232985	-1216	12	19,0	3/4"	16	1	55,5	47,6	6000
1232986	-1612	16	25,0	1"	12	3/4	56,4	41,3	6000
1232987	-1616	16	25,0	1"	16	1	56,4	47,6	6000
1232988	-1620	16	25,0	1"	20	1 1/4	63,4	54,0	6000

// C12A43640

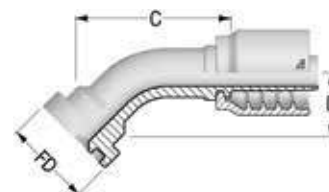
45° Flange SAE 6000 PSI J518 Code 62 - SFS 45
Solid one piece

Item Code	Tail/Head	ID		Flange		Flange Size	FD	C	D Drop	WP
	Dash	Dash	mm	in	Dash Size					
1232989	-0808	08	13,0	1/2"	08	1/2	31,8	56,5	23,0	6000
1232990	-0812	08	13,0	1/2"	12	3/4	41,3	79,9	30,5	6000
1232991	-1212	12	19,0	3/4"	12	3/4	41,3	84,1	31,0	6000
1232992	-1216	12	19,0	3/4"	16	1	47,6	80,0	33,5	6000
1232993	-1616	16	25,0	1"	16	1	47,6	96,7	36,0	6000
1232994	-1620	16	25,0	1"	20	1 1/4	54,0	96,1	39,0	6000

// C12A43690

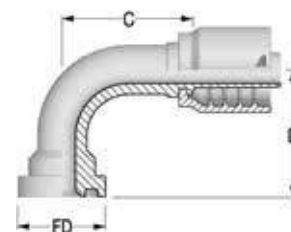
90° Flange SAE 6000 PSI J518 Code 62 - SFS 90
Solid one piece

Item Code	Tail/Head	ID		Flange		Flange Size	FD	C	D Drop	WP
	Dash	Dash	mm	in	Dash Size					
1232995	-0808	08	13,0	1/2"	08	1/2	31,8	47,8	46,0	6000
1232996	-0812	08	13,0	1/2"	12	3/4	41,3	47,8	54,0	6000
1232997	-1012	10	16,0	5/8"	12	3/4	41,3	49,9	55,0	6000
1232998	-1212	12	19,0	3/4"	12	3/4	41,3	63,2	61,0	6000
1232999	-1216	12	19,0	3/4"	16	1	47,6	63,2	66,0	6000
1233000	-1616	16	25,0	1"	16	1	47,6	73,6	75,0	6000
1233001	-1620	16	25,0	1"	20	1 1/4	54,0	77,6	78,0	6000



// ALFACRIMP // C124

// BSP INSERTS..... 162
 // DIN METRIC INSERTS..... 165
 // SAE INSERTS 169
 // JIC 37° INSERTS..... 170

// NPTF INSERTS 174
 // ORFS INSERTS..... 176
 // SAE FLANGES 179
 // C122 SAE FLANGES..... 182

// BSP INSERTS

// C12410510

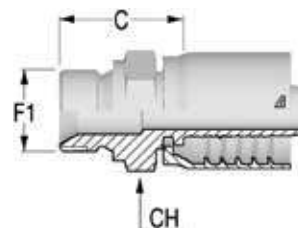
**BSPP Male 60° Flare
AGR**

Item Code	Tail/Head	Nut Type	ID			F1	F1	C	CH
	Dash		Dash	mm	in	Dash Size		mm	mm
1215573	-0606	NA	06	10,0	3/8"	06	3/8-19	27,8	22,0
1233019	-0608	NA	06	10,0	3/8"	08	1/2-14	31,3	27,0
1233020	-0806	NA	08	13,0	1/2"	06	3/8-19	28,6	22,0
1233021	-0808	NA	08	13,0	1/2"	08	1/2-14	32,1	27,0
1233022	-0810	NA	08	13,0	1/2"	10	5/8-14	34,1	30,0
1215574	-0812	NA	08	13,0	1/2"	12	3/4-14	36,1	32,0
1233023	-1010	NA	10	16,0	5/8"	10	5/8-14	34,1	30,0
1233024	-1012	NA	10	16,0	5/8"	12	3/4-14	36,1	32,0
1215575	-1212	NA	12	19,0	3/4"	12	3/4-14	36,6	32,0
1233025	-1216	NA	12	19,0	3/4"	16	1-11	41,6	41,0
1215576	-1616	NA	16	25,0	1"	16	1-11	42,4	41,0
1233026	-1620	NA	16	25,0	1"	20	1 1/4-11	46,4	50,0
1215577	-2020	NA	20	32,0	1 1/4"	20	1 1/4-11	48,0	50,0
1215578	-2424	NA	24	38,0	1 1/2"	24	1 1/2-11	51,0	55,0
1215579	-3232	NA	32	51,0	2"	32	2-11	53,5	70,0

// C12410710

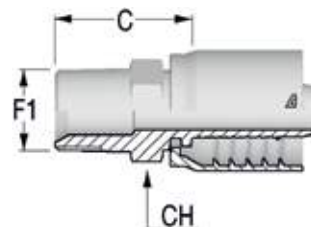
**BSPT Male
AGR K**

Item Code	Tail/Head	Nut Type	ID			F1	F1	C	CH
	Dash		Dash	mm	in	Dash Size		mm	mm
1215580	-0606	NA	06	10,0	3/8"	06	3/8-19	27,8	19,0
1215581	-0608	NA	06	10,0	3/8"	08	1/2-14	32,3	22,0
1215582	-0808	NA	08	13,0	1/2"	08	1/2-14	33,1	22,0
1215583	-1012	NA	10	16,0	5/8"	12	3/4-14	34,1	27,0
1215584	-1212	NA	12	19,0	3/4"	12	3/4-14	34,6	27,0
1215585	-1216	NA	12	19,0	3/4"	16	1-11	43,6	36,0
1215586	-1616	NA	16	25,0	1"	16	1-11	44,4	36,0
1215587	-2020	NA	20	32,0	1 1/4"	20	1 1/4-11	49,0	46,0
1215588	-2424	NA	24	38,0	1 1/2"	24	1 1/2-11	50,5	50,0
1215589	-3232	NA	32	51,0	2"	32	2-11	54,2	65,0

Dimensions shown may be changed without prior notice

// C12420813

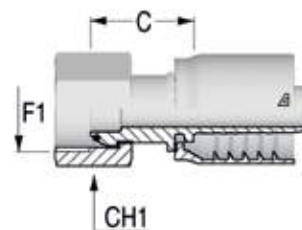
**BSPF Female 60° Cone with O-Ring
DKOR**

Item Code	Tail/Head	Nut Type	ID			F1		F1	C	CH1
	Dash		Dash	mm	in	Dash Size	mm			
1215665	-0606	SN	06	10,0	3/8"	06	3/8-19	23,3	22,0	
1215666	-0608	SN	06	10,0	3/8"	08	1/2-14	24,3	27,0	
1215667	-0808	SN	08	13,0	1/2"	08	1/2-14	25,1	27,0	
1215668	-0810	SN	08	13,0	1/2"	10	5/8-14	28,4	27,0	
1215669	-0812	SN	08	13,0	1/2"	12	3/4-14	29,0	32,0	
1215659	-1010	CR	10	16,0	5/8"	10	5/8-14	17,1	27,0	
1215670	-1012	SN	10	16,0	5/8"	12	3/4-14	29,0	32,0	
1215660	-1212	CR	12	19,0	3/4"	12	3/4-14	20,6	32,0	
1215671	-1216	SN	12	19,0	3/4"	16	1-11	34,0	38,0	
1215661	-1616	CR	16	25,0	1"	16	1-11	23,9	38,0	
1215672	-1620	SN	16	25,0	1"	20	1 1/4-11	39,4	50,0	
1215662	-2020	TN	20	32,0	1 1/4"	20	1 1/4-11	32,0	50,0	
1215673	-2024	SN	20	32,0	1 1/4"	24	1 1/2-11	41,9	55,0	
1215663	-2424	TN	24	38,0	1 1/2"	24	1 1/2-11	33,8	55,0	
1215664	-3232	TN	32	51,0	2"	32	2-11	34,0	70,0	

// C12420843

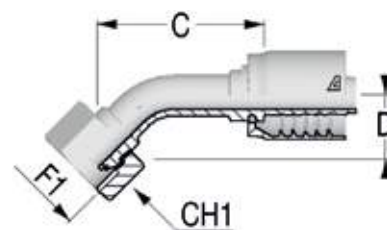
**45° BSPF Female 60° Cone with O-Ring
DKOR 45
Solid one piece**

Item Code	Tail/Head	Nut Type	ID			F1		F1	C	D Drop	CH1
	Dash		Dash	mm	in	Dash Size	mm				
1215681	-0606	SN	06	10,0	3/8"	06	3/8-19	49,9	20,5	22,0	
1215682	-0608	SN	06	10,0	3/8"	08	1/2-14	45,7	21,0	27,0	
1215683	-0808	SN	08	13,0	1/2"	08	1/2-14	55,0	21,0	27,0	
1215684	-0810	SN	08	13,0	1/2"	10	5/8-14	57,2	23,0	27,0	
1215685	-0812	SN	08	13,0	1/2"	12	3/4-14	56,7	23,0	32,0	
1215674	-1010	CR	10	16,0	5/8"	10	5/8-14	64,0	21,5	27,0	
1215686	-1012	SN	10	16,0	5/8"	12	3/4-14	66,5	22,5	32,0	
1215675	-1212	CR	12	19,0	3/4"	12	3/4-14	70,0	28,0	32,0	
1215687	-1216	SN	12	19,0	3/4"	16	1-11	74,6	31,5	38,0	
1215677	-1616	CR	16	25,0	1"	16	1-11	84,0	34,0	38,0	
1215678	-2020	TN	20	32,0	1 1/4"	20	1 1/4-11	100,8	40,0	50,0	
1215679	-2424	TN	24	38,0	1 1/2"	24	1 1/2-11	115,7	46,0	55,0	
1215680	-3232	TN	32	51,0	2"	32	2-11	151,5	60,0	70,0	

// C12420893

90° BSPP Female 60° Cone with O-Ring

DKOR 90

Solid one piece

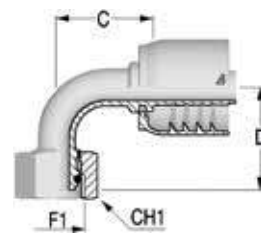

Item Code	Tail/Head	Nut Type	ID			F1	F1	C	D Drop	CH1
	Dash		Dash	mm	in	Dash Size				
1215696	-0606	SN	06	10,0	3/8"	06	3/8-19	34,8	42,0	22,0
1215697	-0608	SN	06	10,0	3/8"	08	1/2-14	34,3	35,5	27,0
1215698	-0808	SN	08	13,0	1/2"	08	1/2-14	35,8	41,0	27,0
1215699	-0810	SN	08	13,0	1/2"	10	5/8-14	41,6	43,5	27,0
1233027	-0812	SN	08	13,0	1/2"	12	3/4-14	41,8	43,0	32,0
1215690	-1010	CR	10	16,0	5/8"	10	5/8-14	47,9	47,0	27,0
1233028	-1012	SN	10	16,0	5/8"	12	3/4-14	51,9	49,0	32,0
1215691	-1212	CR	12	19,0	3/4"	12	3/4-14	49,1	53,0	32,0
1215700	-1216	SN	12	19,0	3/4"	16	1-11	54,1	60,5	38,0
1215692	-1616	CR	16	25,0	1"	16	1-11	75,1	69,0	38,0
1233029	-1620	SN	16	25,0	1"	20	1 1/4-11	75,1	88,5	50,0
1215693	-2020	TN	20	32,0	1 1/4"	20	1 1/4-11	82,3	83,0	50,0
1215694	-2424	TN	24	38,0	1 1/2"	24	1 1/2-11	95,7	96,0	55,0
1215695	-3232	TN	32	51,0	2"	32	2-11	128,5	136,0	70,0

Dimensions shown may be changed without prior notice

// DIN METRIC INSERTS

// C12411110

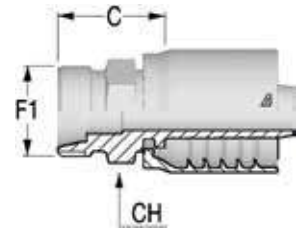
Metric Male 24° Seat - Light
DIN 3853 - CEL

Item Code	Tail/Head Dash/mm	Nut Type	ID			F1	OD1 mm	C mm	CH mm
			Dash	mm	in				
1215590	-0616	NA	06	10,0	3/8"	M16X1.5	10	23,3	17,0
1215591	-0618	NA	06	10,0	3/8"	M18X1.5	12	24,3	19,0
1230378	-0622	NA	06	10,0	3/8"	M22X1.5	15	25,3	22,0
1215592	-0822	NA	08	13,0	1/2"	M22X1.5	15	26,1	22,0
1230379	-0826	NA	08	13,0	1/2"	M26X1.5	18	27,1	27,0
1215593	-1026	NA	10	16,0	5/8"	M26X1.5	18	27,1	27,0
1215594	-1230	NA	12	19,0	3/4"	M30X2	22	31,6	32,0
1215595	-1636	NA	16	25,0	1"	M36X2	28	34,4	36,0
1215596	-2045	NA	20	32,0	1 1/4"	M45X2	35	40,0	46,0
1233030	-2452	NA	24	38,0	1 1/2"	M52X2	42	42,0	55,0

// C12421513

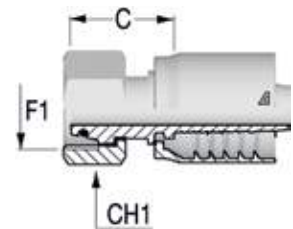
Metric Female 24° Cone with O-Ring - Light
DIN 3865 - DKOL

Item Code	Tail/Head Dash/mm	Nut Type	ID			F1	OD1 mm	C mm	CH1 mm
			Dash	mm	in				
1215702	-0618	SN	06	10,0	3/8"	M18X1.5	12	25,4	22,0
1215703	-0822	SN	08	13,0	1/2"	M22X1.5	15	28,2	27,0
1215704	-1026	SN	10	16,0	5/8"	M26X1.5	18	29,2	32,0
1215705	-1230	SN	12	19,0	3/4"	M30X2	22	31,7	36,0
1215706	-1636	SN	16	25,0	1"	M36X2	28	33,6	41,0
1215707	-2045	SN	20	32,0	1 1/4"	M45X2	35	40,1	50,0
1230386	-2452	SN	24	38,0	1 1/2"	M52X2	42	40,5	60,0

// C12421543

45° Metric Female 24° Cone with O-Ring - Light
DIN 3865 - DKOL 45
Solid one piece

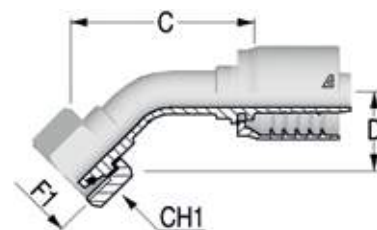

Item Code	Tail/Head Dash/mm	Nut Type	ID			F1	OD1	C	D Drop	CH1
			Dash	mm	in					
1215708	-0618	SN	06	10,0	3/8"	M18X1.5	12	46,8	19,5	22,0
1215709	-0822	SN	08	13,0	1/2"	M22X1.5	15	55,0	21,0	22,0
1215710	-1026	SN	10	16,0	5/8"	M26X1.5	18	65,3	24,0	32,0
1215711	-1230	SN	12	19,0	3/4"	M30X2	22	69,4	32,0	36,0
1215712	-1636	SN	16	25,0	1"	M36X2	28	91,4	32,0	41,0
1233031	-2045	SN	20	32,0	1 1/4"	M45X2	35	141,5	45,0	50,0

// C12421593

90° Metric Female 24° Cone with O-Ring - Light
DIN 3865 - DKOL 90
Solid one piece

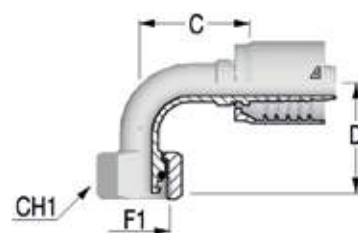

Item Code	Tail/Head Dash/mm	Nut Type	ID			F1	OD1	C	D Drop	CH1
			Dash	mm	in					
1215713	-0618	SN	06	10,0	3/8"	M18X1.5	12	32,8	39,0	22,0
1215714	-0822	SN	08	13,0	1/2"	M22X1.5	15	39,8	40,5	27,0
1215715	-1026	SN	10	16,0	5/8"	M26X1.5	18	51,4	48,0	32,0
1215716	-1230	SN	12	19,0	3/4"	M30X2	22	52,1	59,0	36,0
1215717	-1636	SN	16	25,0	1"	M36X2	28	77,6	68,0	41,0
1215718	-2045	SN	20	32,0	1 1/4"	M45X2	35	90,5	89,0	50,0
1230388	-2452	SN	24	38,0	1 1/2"	M52X2	42	106,5	100,0	60,0

Dimensions shown may be changed without prior notice

// C12411210

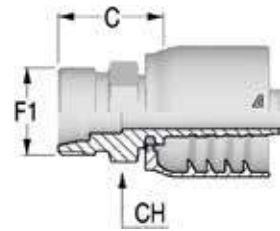
**Metric Male 24° Seat - Heavy
DIN 3853 - CES**

Item Code	Tail/Head Dash/mm	Nut Type	ID			F1	OD1 mm	C mm	CH mm
			Dash	mm	in				
1215597	-0620	NA	06	10,0	3/8"	M20X1.5	12	25,3	22,0
1215598	-0622	NA	06	10,0	3/8"	M22X1.5	14	27,3	22,0
1215599	-0824	NA	08	13,0	1/2"	M24X1.5	16	29,1	24,0
1215600	-1030	NA	10	16,0	5/8"	M30X2	20	33,1	32,0
1215601	-1230	NA	12	19,0	3/4"	M30X2	20	33,6	32,0
1215602	-1236	NA	12	19,0	3/4"	M36X2	25	37,6	36,0
1215603	-1642	NA	16	25,0	1"	M42X2	30	42,4	46,0
1233032	-2052	NA	20	32,0	1 1/4"	M52X2	38	48,0	55,0

// C12421613

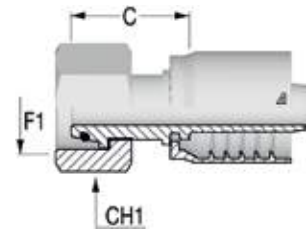
**Metric Female 24° Cone with O-Ring - Heavy
DIN 3865 - DKOS**

Item Code	Tail/Head Dash/mm	Nut Type	ID			F1	OD1 mm	C mm	CH1 mm
			Dash	mm	in				
1215720	-0620	SN	06	10,0	3/8"	M20X1.5	12	27,6	24,0
1215721	-0622	SN	06	10,0	3/8"	M22X1.5	14	31,1	27,0
1215722	-0824	SN	08	13,0	1/2"	M24X1.5	16	31,7	30,0
1215723	-1030	SN	10	16,0	5/8"	M30X2	20	36,5	36,0
1215724	-1230	SN	12	19,0	3/4"	M30X2	20	37,0	36,0
1215725	-1236	SN	12	19,0	3/4"	M36X2	25	40,2	46,0
1230389	-1636	SN	16	25,0	1"	M36X2	25	41,0	46,0
1215726	-1642	SN	16	25,0	1"	M42X2	30	43,1	50,0
1215727	-2042	SN	20	32,0	1 1/4"	M42X2	30	44,7	50,0
1215728	-2052	SN	20	32,0	1 1/4"	M52X2	38	48,1	60,0

// C12421643

45° Metric Female 24° Cone with O-Ring - Heavy
DIN 3865 - DKOS 45
Solid one piece

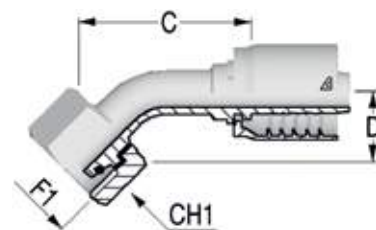

Item Code	Tail/Head Dash/mm	Nut Type	ID			F1	OD1 mm	C mm	D Drop mm	CH1 mm
			Dash	mm	in					
1215729	-0620	SN	06	10,0	3/8"	M20X1.5	12	50,6	20,0	24,0
1233033	-0622	SN	06	10,0	3/8"	M22X1.5	14	52,9	21,0	27,0
1215730	-0824	SN	08	13,0	1/2"	M24X1.5	16	55,8	21,5	30,0
1215731	-1030	SN	10	16,0	5/8"	M30X2	20	66,3	30,0	36,0
1215732	-1236	SN	12	19,0	3/4"	M36X2	25	69,5	33,0	46,0
1215733	-1642	SN	16	25,0	1"	M42X2	30	110,3	40,5	50,0
1215734	-2052	SN	20	32,0	1 1/4"	M52X2	38	109,0	45,0	60,0

// C12421693

90° Metric Female 24° Cone with O-Ring - Heavy
DIN 3865 - DKOS 90
Solid one piece

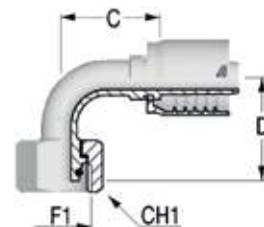

Item Code	Tail/Head Dash/mm	Nut Type	ID			F1	OD1 mm	C mm	D Drop mm	CH1 mm
			Dash	mm	in					
1215735	-0620	SN	06	10,0	3/8"	M20X1.5	12	34,3	38,5	24,0
1215736	-0622	SN	06	10,0	3/8"	M22X1.5	14	34,3	40,5	27,0
1215737	-0824	SN	08	13,0	1/2"	M24X1.5	16	39,8	41,5	30,0
1215738	-1030	SN	10	16,0	5/8"	M30X2	20	47,9	55,0	36,0
1215739	-1236	SN	12	19,0	3/4"	M36X2	25	50,6	59,5	46,0
1215740	-1642	SN	16	25,0	1"	M42X2	30	75,6	79,0	50,0
1215741	-2052	SN	20	32,0	1 1/4"	M52X2	38	94,0	92,0	60,0

Dimensions shown may be changed without prior notice

// SAE INSERTS

// C12413010

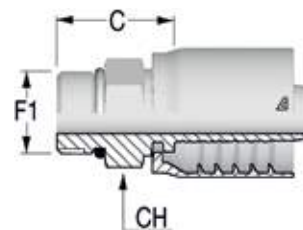
SAE Male Solid
O-Ring Boss

Item Code	Tail/Head	Nut Type	ID			F1	F1	C	CH
	Dash		Dash	mm	in	Dash Size		mm	mm
1233039	-0606	NA	06	10,0	3/8"	06	9/16-18	23,3	19,0
1215653	-0808	NA	08	13,0	1/2"	08	3/4-16	25,1	22,0
1233040	-0810	NA	08	13,0	1/2"	10	7/8-14	27,6	27,0
1233041	-0812	NA	08	13,0	1/2"	12	1 1/16-12	32,1	32,0
1233042	-1012	NA	10	16,0	5/8"	12	1 1/16-12	32,1	32,0
1233043	-1210	NA	12	19,0	3/4"	10	7/8-14	28,1	27,0
1215654	-1212	NA	12	19,0	3/4"	12	1 1/16-12	32,6	32,0
1215655	-1216	NA	12	19,0	3/4"	16	1 5/16-12	34,6	38,0
1215656	-1616	NA	16	25,0	1"	16	1 5/16-12	35,4	38,0

// JIC 37° INSERTS

// C12412510

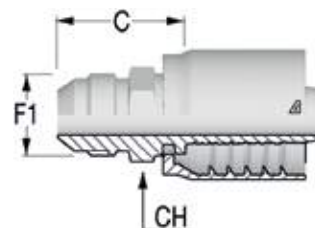
JIC Male 37° Cone
AGJ

Item Code	Tail/Head	Nut Type	ID			F1	F1	C	CH
	Dash		Dash	mm	in	Dash Size			
1215616	-0606	NA	06	10,0	3/8"	06	9/16-18	26,3	17,0
1215617	-0608	NA	06	10,0	3/8"	08	3/4-16	29,8	19,0
1215618	-0808	NA	08	13,0	1/2"	08	3/4-16	30,6	19,0
1215619	-0810	NA	08	13,0	1/2"	10	7/8-14	34,6	24,0
1215620	-0812	NA	08	13,0	1/2"	12	1 1/16-12	37,1	27,0
1215621	-1010	NA	10	16,0	5/8"	10	7/8-14	34,6	24,0
1215622	-1012	NA	10	16,0	5/8"	12	1 1/16-12	37,1	27,0
1215623	-1212	NA	12	19,0	3/4"	12	1 1/16-12	37,6	27,0
1215624	-1214	NA	12	19,0	3/4"	14	1 3/16-12	40,1	32,0
1215625	-1216	NA	12	19,0	3/4"	16	1 5/16-12	42,6	36,0
1215626	-1616	NA	16	25,0	1"	16	1 5/16-12	43,4	36,0
1215627	-1620	NA	16	25,0	1"	20	1 5/8-12	46,9	46,0
1215628	-2020	NA	20	32,0	1 1/4"	20	1 5/8-12	48,5	46,0
1215630	-2424	NA	24	38,0	1 1/2"	24	1 7/8-12	52,5	50,0

// C12422511

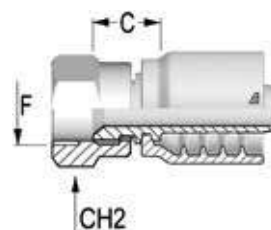
JIC Female 37° Seat
DKJ

Item Code	Tail/Head	Nut Type	ID			F1	F1	C	CH1
	Dash		Dash	mm	in	Dash Size			
1215802	-0606	CR	06	10,0	3/8"	06	9/16-18	15,3	19,0
1233034	-0608	CR	06	10,0	3/8"	08	3/4-16	17,8	25,0
1230393	-0808	CR	08	13,0	1/2"	08	3/4-16	18,6	25,0
1215803	-0810	CR	08	13,0	1/2"	10	7/8-14	19,6	27,0
1215804	-0812	CR	08	13,0	1/2"	12	1 1/16-12	22,1	32,0
1215805	-1010	CR	10	16,0	5/8"	10	7/8-14	19,6	27,0
1215806	-1012	CR	10	16,0	5/8"	12	1 1/16-12	20,1	32,0
1215807	-1210	CR	12	19,0	3/4"	10	7/8-14	20,1	27,0
1215808	-1212	CR	12	19,0	3/4"	12	1 1/16-12	20,6	32,0
1215809	-1214	CR	12	19,0	3/4"	14	1 3/16-12	19,9	36,0
1233035	-1216	CR	12	19,0	3/4"	16	1 5/16-12	22,1	38,0
1230394	-1616	CR	16	25,0	1"	16	1 5/16-12	23,9	38,0
1233036	-1620	TN	16	25,0	1"	20	1 5/8-12	26,5	50,0
1215810	-2020	TN	20	32,0	1 1/4"	20	1 5/8-12	28,1	50,0
1233037	-2024	TN	20	32,0	1 1/4"	24	1 7/8-12	30,4	55,0
1215811	-2424	TN	24	38,0	1 1/2"	24	1 7/8-12	29,4	55,0
1215812	-3232	TN	32	51,0	2"	32	2 1/2-12	32,0	70,0

Dimensions shown may be changed without prior notice

// C12426511

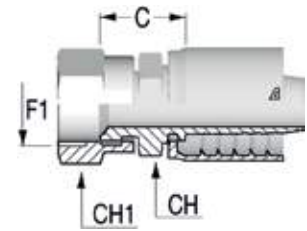
**JIC Female 37° Seat with Stem Hexagon
DKJ**

Item Code	Tail/Head	Nut Type	ID			F1	F1	C	CH	CH1
	Dash		Dash	mm	in	Dash Size		mm	mm	mm
1215874	-0606	CR	06	10,0	3/8"	06	9/16-18	21,3	17,0	19,0
1215875	-0608	CR	06	10,0	3/8"	08	3/4-16	24,8	19,0	25,0
1215876	-0806	CR	08	13,0	1/2"	06	9/16-18	23,1	19,0	19,0
1215877	-0808	CR	08	13,0	1/2"	08	3/4-16	25,6	19,0	25,0
1215878	-0810	CR	08	13,0	1/2"	10	7/8-14	26,6	22,0	27,0
1215879	-0812	CR	08	13,0	1/2"	12	1 1/16-12	28,1	25,0	32,0
1215880	-1008	CR	10	16,0	5/8"	08	3/4-16	26,6	24,0	25,0
1214172	-1010	CR	10	16,0	5/8"	10	7/8-14	27,6	24,0	27,0
1215881	-1012	CR	10	16,0	5/8"	12	1 1/16-12	28,1	25,0	32,0
1215883	-1212	CR	12	19,0	3/4"	12	1 1/16-12	28,6	27,0	32,0
1215885	-1216	CR	12	19,0	3/4"	16	1 5/16-12	32,1	32,0	38,0
1215886	-1612	CR	16	25,0	1"	12	1 1/16-12	31,4	32,0	32,0
1215887	-1616	CR	16	25,0	1"	16	1 5/16-12	32,9	32,0	38,0
1215888	-1620	TN	16	25,0	1"	20	1 5/8-12	37,5	41,0	50,0
1215889	-2020	TN	20	32,0	1 1/4"	20	1 5/8-12	39,1	41,0	50,0
1215890	-2024	TN	20	32,0	1 1/4"	24	1 7/8-12	43,4	50,0	55,0
1215891	-2424	TN	24	38,0	1 1/2"	24	1 7/8-12	43,4	50,0	55,0
1215892	-3232	TN	32	51,0	2"	32	2 1/2-12	49,0	65,0	70,0

// C12422541-M

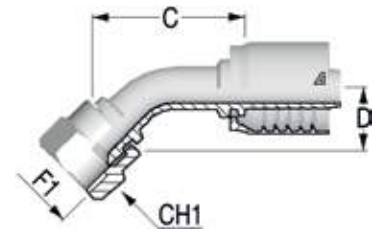
**45° JIC Female 37° Seat - Medium Drop
DKJ 45M
Solid one piece**

Item Code	Tail/Head	Nut Type	ID			F1	F1	C	D Drop	CH1
	Dash		Dash	mm	in	Dash Size		mm	mm	mm
1215813	-0606	CR	06	10,0	3/8"	06	9/16-18	46,3	11,0	19,0
1215814	-0608	CR	06	10,0	3/8"	08	3/4-16	47,2	15,0	25,0
1215815	-0808	CR	08	13,0	1/2"	08	3/4-16	51,6	15,0	25,0
1215816	-0810	CR	08	13,0	1/2"	10	7/8-14	50,7	16,0	27,0
1215817	-0812	CR	08	13,0	1/2"	12	1 1/16-12	57,0	21,0	32,0
1215818	-1010	CR	10	16,0	5/8"	10	7/8-14	62,2	19,0	27,0
1230395	-1012	CR	10	16,0	5/8"	12	1 1/16-12	68,6	21,0	32,0
1215819	-1212	CR	12	19,0	3/4"	12	1 1/16-12	67,5	21,0	32,0
1215821	-1216	CR	12	19,0	3/4"	16	1 5/16-12	71,4	26,0	38,0
1215822	-1616	CR	16	25,0	1"	16	1 5/16-12	79,4	24,0	38,0
1215824	-1620	TN	16	25,0	1"	20	1 5/8-12	83,8	37,0	50,0
1215825	-2020	TN	20	32,0	1 1/4"	20	1 5/8-12	97,1	37,0	50,0
1215827	-2424	TN	24	38,0	1 1/2"	24	1 7/8-12	112,7	43,0	55,0
1215828	-3232	TN	32	51,0	2"	32	2 1/2-12	159,9	67,0	70,0

// C12422591-S

90° JIC Female 37° Seat - Short Drop

DKJ 90S

Solid one piece

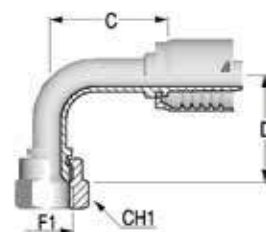

Item Code	Tail/Head	Nut Type	ID			F1	F1	C	D Drop	CH1
	Dash		Dash	mm	in	Dash Size				
1230396	-0812	CR	08	13,0	1/2"	12	1 1/16-12	37,3	46,0	32,0
1215850	-1212	CR	12	19,0	3/4"	12	1 1/16-12	58,2	46,0	32,0
1215854	-1216	CR	12	19,0	3/4"	16	1 5/16-12	53,6	53,0	38,0
1215857	-1616	CR	16	25,0	1"	16	1 5/16-12	74,0	56,0	38,0

// C12422591-M

90° JIC Female 37° Seat - Medium Drop

DKJ 90M

Solid one piece

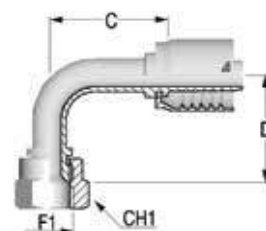

Item Code	Tail/Head	Nut Type	ID			F1	F1	C	D Drop	CH1
	Dash		Dash	mm	in	Dash Size				
1215830	-0606	CR	06	10,0	3/8"	06	9/16-18	31,3	35,0	19,0
1215833	-0608	CR	06	10,0	3/8"	08	3/4-16	39,5	41,0	25,0
1215836	-0808	CR	08	13,0	1/2"	08	3/4-16	37,2	40,0	25,0
1215839	-0810	CR	08	13,0	1/2"	10	7/8-14	43,3	47,0	27,0
1233038	-0812	CR	08	13,0	1/2"	12	1 1/16-12	42,8	58,0	32,0
1215842	-1010	CR	10	16,0	5/8"	10	7/8-14	49,4	48,0	27,0
1215845	-1012	CR	10	16,0	5/8"	12	1 1/16-12	47,9	58,0	32,0
1215849	-1212	CR	12	19,0	3/4"	12	1 1/16-12	52,4	54,0	32,0
1215853	-1216	CR	12	19,0	3/4"	16	1 5/16-12	52,6	72,0	38,0
1215856	-1616	CR	16	25,0	1"	16	1 5/16-12	72,6	71,5	38,0
1230398	-1620	TN	16	25,0	1"	20	1 5/8-12	72,6	78,0	50,0
1215858	-2020	TN	20	32,0	1 1/4"	20	1 5/8-12	82,4	78,0	50,0
1215860	-2424	TN	24	38,0	1 1/2"	24	1 7/8-12	95,3	92,0	55,0
1215861	-3232	TN	32	51,0	2"	32	2 1/2-12	129,5	140,0	70,0

Dimensions shown may be changed without prior notice

// C12422591-L

90° JIC Female 37° Seat - Long Drop
DKJ 90L
Solid one piece

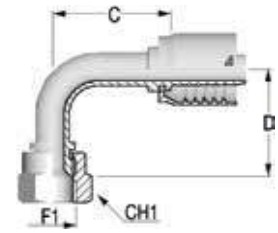

Item Code	Tail/Head	Nut Type	ID			F1	F1	C	D Drop	CH1
	Dash		Dash	mm	in	Dash Size				
1215829	-0606	CR	06	10,0	3/8"	06	9/16-18	43,3	54,0	19,0
1215832	-0608	CR	06	10,0	3/8"	08	3/4-16	46,8	64,0	25,0
1215835	-0808	CR	08	13,0	1/2"	08	3/4-16	49,9	64,0	25,0
1215838	-0810	CR	08	13,0	1/2"	10	7/8-14	37,3	65,0	27,0
1215841	-1010	CR	10	16,0	5/8"	10	7/8-14	49,9	65,0	27,0
1215848	-1212	CR	12	19,0	3/4"	12	1 1/16-12	54,1	95,0	32,0
1215855	-1616	CR	16	25,0	1"	16	1 5/16-12	78,6	114,0	38,0

// NPTF INSERTS

// C12412810

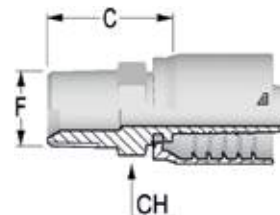
NPTF Male 60° Seat
AGN

Item Code	Tail/Head	Nut Type	ID			F1	F1	C	CH
	Dash		Dash	mm	in	Dash Size			
1215632	-0604	NA	06	10,0	3/8"	04	1/4-18	26,8	17,0
1215633	-0606	NA	06	10,0	3/8"	06	3/8-18	27,8	19,0
1215634	-0608	NA	06	10,0	3/8"	08	1/2-14	31,3	22,0
1215635	-0806	NA	08	13,0	1/2"	06	3/8-18	28,6	19,0
1215636	-0808	NA	08	13,0	1/2"	08	1/2-14	32,1	22,0
1215637	-0812	NA	08	13,0	1/2"	12	3/4-14	34,1	27,0
1215638	-1012	NA	10	16,0	5/8"	12	3/4-14	34,1	27,0
1215639	-1208	NA	12	19,0	3/4"	08	1/2-14	33,6	27,0
1215640	-1212	NA	12	19,0	3/4"	12	3/4-14	34,6	27,0
1215641	-1216	NA	12	19,0	3/4"	16	1-11 1/2	43,6	36,0
1215643	-1616	NA	16	25,0	1"	16	1-11 1/2	44,4	36,0
1215644	-1620	NA	16	25,0	1"	20	1 1/4-11 1/2	47,4	46,0
1215645	-2020	NA	20	32,0	1 1/4"	20	1 1/4-11 1/2	49,0	46,0
1215646	-2024	NA	20	32,0	1 1/4"	24	1 1/2-11 1/2	50,5	50,0
1215647	-2424	NA	24	38,0	1 1/2"	24	1 1/2-11 1/2	50,5	50,0
1215648	-3232	NA	32	51,0	2"	32	2-11 1/2	54,2	65,0

// C12422810

NPTF Female Solid

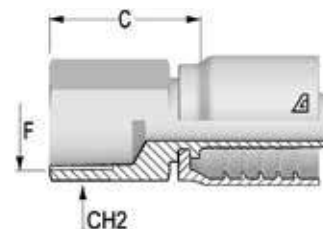

Item Code	Tail/Head	Nut Type	ID			F1	F1	C	CH
	Dash		Dash	mm	in	Dash Size			
1215862	-1212	NA	12	19,0	3/4"	12	3/4-14	38,1	32,0
1215863	-1616	NA	16	25,0	1"	16	1-11 1/2	44,9	38,0

Dimensions shown may be changed without prior notice

// C12412811

NPTF Male Swivel 60° Seat

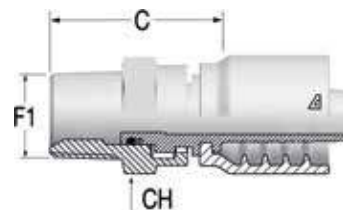

Item Code	Tail/Head	Nut Type	ID			F1	F1	C	CH
	Dash		Dash	mm	in	Dash Size			
1215650	-0808	CR	08	13,0	1/2"	08	1/2-14	42,3	25,0
1215651	-1212	CR	12	19,0	3/4"	12	3/4-14	50,1	32,0
1215652	-1616	CR	16	25,0	1"	16	1-11 1/2	57,9	41,0

// ORFS INSERTS

// C12412410

ORFS Male

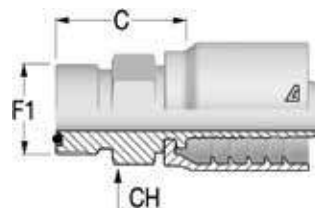

Item Code	Tail/Head	Nut Type	ID			F1	F1	C	CH
	Dash		Dash	mm	in	Dash Size			
1215604	-0606	NA	06	10,0	3/8"	06	11/16-16	24,3	19,0
1215606	-0808	NA	08	13,0	1/2"	08	13/16-16	27,1	22,0
1215607	-0810	NA	08	13,0	1/2"	10	1-14	30,6	27,0
1215611	-1212	NA	12	19,0	3/4"	12	1 3/16-12	34,6	32,0
1215612	-1216	NA	12	19,0	3/4"	16	1 7/16-12	38,1	41,0
1215613	-1616	NA	16	25,0	1"	16	1 7/16-12	37,9	38,0
1215615	-2020	NA	20	32,0	1 1/4"	20	1 11/16-12	41,5	46,0

// C12422411

ORFS Female with Stem Hexagon

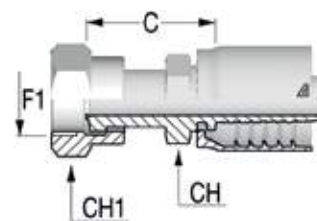

Item Code	Tail/Head	Nut Type	ID			F1	F1	C	CH	CH1
	Dash		Dash	mm	in	Dash Size				
1215742	-0606	CR	06	10,0	3/8"	06	11/16-16	30,3	17,0	22,0
1215743	-0608	CR	06	10,0	3/8"	08	13/16-16	35,3	22,0	24,0
1215744	-0808	CR	08	13,0	1/2"	08	13/16-16	36,1	22,0	24,0
1215745	-0810	CR	08	13,0	1/2"	10	1-14	39,6	24,0	30,0
1215746	-0812	CR	08	13,0	1/2"	12	1 3/16-12	42,1	30,0	36,0
1215747	-1010	CR	10	16,0	5/8"	10	1-14	39,6	24,0	30,0
1215748	-1012	CR	10	16,0	5/8"	12	1 3/16-12	42,1	30,0	36,0
1215749	-1210	CR	12	19,0	3/4"	10	1-14	40,1	27,0	30,0
1215750	-1212	CR	12	19,0	3/4"	12	1 3/16-12	42,6	30,0	36,0
1215751	-1216	CR	12	19,0	3/4"	16	1 7/16-12	48,6	36,0	41,0
1215752	-1612	CR	16	25,0	1"	12	1 3/16-12	45,4	32,0	36,0
1215753	-1616	CR	16	25,0	1"	16	1 7/16-12	49,4	36,0	41,0
1215754	-1620	CR	16	25,0	1"	20	1 11/16-12	50,4	41,0	50,0
1215755	-2020	CR	20	32,0	1 1/4"	20	1 11/16-12	52,0	41,0	50,0
1215756	-2424	CR	24	38,0	1 1/2"	24	2-12	56,5	50,0	60,0

Dimensions shown may be changed without prior notice

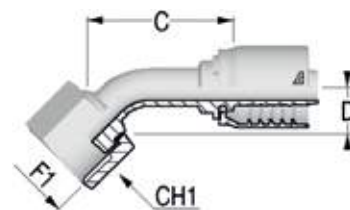
// C12422443-M**45° ORFS Female - Medium Drop****DK ORFS 45M****Solid one piece**

Item Code	Tail/Head	Nut Type	ID			F1	F1	C	D Drop	CH1
	Dash		Dash	mm	in	Dash Size				
1215759	-0606	SN	06	10,0	3/8"	06	11/16-16	47,4	12,0	22,0
1215760	-0608	SN	06	10,0	3/8"	08	13/16-16	51,2	15,0	24,0
1215757	-0808	CR	08	13,0	1/2"	08	13/16-16	47,1	16,0	24,0
1215761	-0810	SN	08	13,0	1/2"	10	1-14	50,4	16,5	30,0
1215762	-1010	SN	10	16,0	5/8"	10	1-14	57,7	17,0	30,0
1230391	-1012	SN	10	16,0	5/8"	12	1 3/16-12	63,1	21,0	36,0
1215763	-1212	SN	12	19,0	3/4"	12	1 3/16-12	63,5	21,0	36,0
1215764	-1216	SN	12	19,0	3/4"	16	1 7/16-12	70,7	24,0	41,0
1215765	-1616	SN	16	25,0	1"	16	1 7/16-12	82,4	26,0	41,0
1215766	-1620	SN	16	25,0	1"	20	1 11/16-12	85,4	26,0	50,0
1215767	-2020	SN	20	32,0	1 1/4"	20	1 11/16-12	97,4	26,0	50,0
1215769	-2424	SN	24	38,0	1 1/2"	24	2-12	104,4	28,0	60,0

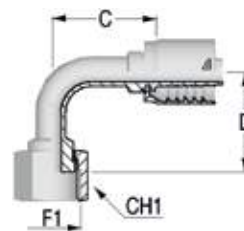
// C12422493-S**90° ORFS Female - Short Drop****DK ORFS 90S****Solid one piece**

Item Code	Tail/Head	Nut Type	ID			F1	F1	C	D Drop	CH1
	Dash		Dash	mm	in	Dash Size				
1215777	-0606	SN	06	10,0	3/8"	06	11/16-16	41,8	25,0	22,0
1215772	-0808	CR	08	13,0	1/2"	08	13/16-16	39,8	29,0	24,0
1215781	-0810	SN	08	13,0	1/2"	10	1-14	46,3	32,5	30,0
1233044	-1010	SN	10	16,0	5/8"	10	1-14	52,3	32,5	30,0
1215786	-1212	SN	12	19,0	3/4"	12	1 3/16-12	60,6	51,0	36,0
1215792	-1616	SN	16	25,0	1"	16	1 7/16-12	80,0	58,0	41,0
1215795	-2020	SN	20	32,0	1 1/4"	20	1 11/16-12	95,0	68,0	50,0

// C12422493-M

90° ORFS Female - Medium Drop

DK ORFS 90M

Solid one piece

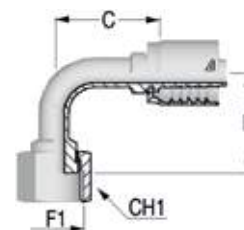

Item Code	Tail/Head	Nut Type	ID			F1	F1	C	D Drop	CH1
	Dash		Dash	mm	in	Dash Size				
1215776	-0606	SN	06	10,0	3/8"	06	11/16-16	41,8	38,0	22,0
1215778	-0608	SN	06	10,0	3/8"	08	13/16-16	43,8	41,0	24,0
1215771	-0808	CR	08	13,0	1/2"	08	13/16-16	34,8	42,0	24,0
1215780	-0810	SN	08	13,0	1/2"	10	1-14	48,3	47,0	30,0
1215782	-1010	SN	10	16,0	5/8"	10	1-14	55,4	44,0	30,0
1230392	-1012	SN	10	16,0	5/8"	12	1 3/16-12	55,4	58,0	36,0
1215785	-1212	SN	12	19,0	3/4"	12	1 3/16-12	61,6	58,0	36,0
1215788	-1216	SN	12	19,0	3/4"	16	1 7/16-12	65,6	71,0	41,0
1215791	-1616	SN	16	25,0	1"	16	1 7/16-12	82,6	66,0	41,0
1215794	-2020	SN	20	32,0	1 1/4"	20	1 11/16-12	97,0	78,0	50,0
1215800	-2424	SN	24	38,0	1 1/2"	24	2-12	107,8	87,0	60,0

// C12422493-L

90° ORFS Female - Long Drop

DK ORFS 90L

Solid one piece

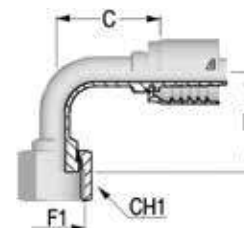

Item Code	Tail/Head	Nut Type	ID			F1	F1	C	D Drop	CH1
	Dash		Dash	mm	in	Dash Size				
1215775	-0606	SN	06	10,0	3/8"	06	11/16-16	41,8	54,0	22,0
1215770	-0808	CR	08	13,0	1/2"	08	13/16-16	38,3	64,0	24,0
1215779	-0810	SN	08	13,0	1/2"	10	1-14	46,3	70,0	30,0
1233045	-1010	SN	10	16,0	5/8"	10	1-14	55,4	70,0	30,0
1215784	-1212	SN	12	19,0	3/4"	12	1 3/16-12	61,6	96,0	36,0
1215790	-1616	SN	16	25,0	1"	16	1 7/16-12	82,6	114,0	41,0

Dimensions shown may be changed without prior notice

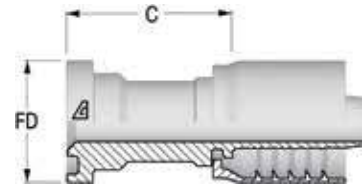
// SAE FLANGES**// C12443310****Flange SAE 3000 PSI J518 Code 61 - SFL**

Item Code	Tail/Head	ID		Flange		C	FD	WP	
	Dash	Dash	mm	in	Dash Size				Flange Size
1215898	-0808	08	13,0	1/2"	08	1/2	41,0	30,2	5000
1215899	-0812	08	13,0	1/2"	12	3/4	42,0	38,1	5000
1215901	-1212	12	19,0	3/4"	12	3/4	42,5	38,1	5000
1215902	-1216	12	19,0	3/4"	16	1	50,5	44,5	5000
1215903	-1616	16	25,0	1"	16	1	51,4	44,5	5000
1215904	-1620	16	25,0	1"	20	1 1/4	53,9	50,8	4000
1215906	-2020	20	32,0	1 1/4"	20	1 1/4	55,5	50,8	4000
1215907	-2024	20	32,0	1 1/4"	24	1 1/2	58,5	60,3	3000
1215908	-2424	24	38,0	1 1/2"	24	1 1/2	58,5	60,3	3000
1215910	-3232	32	51,0	2"	32	2	70,0	71,4	3000
1215911	-3240	32	51,0	2"	40	2 1/2	83,0	81,1	2500

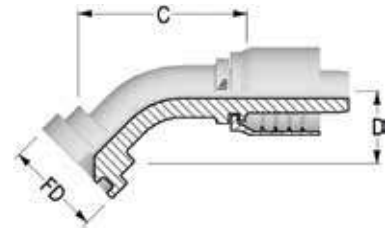
// C12443340**45° Flange SAE 3000 PSI J518 Code 61 - SFL 45
Solid one piece**

Item Code	Tail/Head	ID		Flange		FD	C	D Drop	WP	
	Dash	Dash	mm	in	Dash Size					Flange Size
1215931	-0808	08	13,0	1/2"	08	1/2	30,2	52,9	22,0	5000
1215932	-0812	08	13,0	1/2"	12	3/4	38,1	60,3	26,0	5000
1215933	-1212	12	19,0	3/4"	12	3/4	38,1	73,7	32,0	5000
1215934	-1216	12	19,0	3/4"	16	1	44,5	77,9	29,0	5000
1215935	-1616	16	25,0	1"	16	1	44,5	82,7	33,5	5000
1215936	-1620	16	25,0	1"	20	1 1/4	50,8	82,2	36,0	4000
1215937	-2020	20	32,0	1 1/4"	20	1 1/4	50,8	95,1	37,5	4000
1215938	-2024	20	32,0	1 1/4"	24	1 1/2	60,3	104,1	40,0	3000
1215939	-2424	24	38,0	1 1/2"	24	1 1/2	60,3	116,7	48,0	3000
1215940	-2432	24	38,0	1 1/2"	32	2	71,4	135,6	55,5	3000
1215941	-3232	32	51,0	2"	32	2	71,4	140,8	47,5	3000

// C12443390

90° Flange SAE 3000 PSI J518 Code 61 - SFL 90
Solid one piece

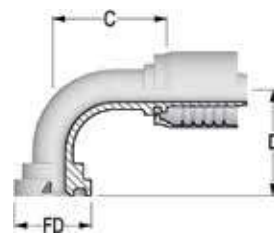

Item Code	Tail/Head	ID		Flange		Flange Size	FD	C	D Drop	WP
	Dash	Dash	mm	in	Dash Size					
1215959	-0808	08	13,0	1/2"	08	1/2	30,2	45,8	42,0	5000
1215960	-0812	08	13,0	1/2"	12	3/4	38,1	45,3	51,0	5000
1215961	-1212	12	19,0	3/4"	12	3/4	38,1	59,7	58,0	5000
1215962	-1216	12	19,0	3/4"	16	1	44,5	66,2	64,5	5000
1215966	-1616	16	25,0	1"	16	1	44,5	70,6	67,0	5000
1215968	-1620	16	25,0	1"	20	1 1/4	50,8	73,6	71,0	4000
1215969	-1624	16	25,0	1"	24	1 1/2	60,3	93,1	75,0	3000
1215970	-2016	20	32,0	1 1/4"	16	1	44,5	94,4	65,0	5000
1215971	-2020	20	32,0	1 1/4"	20	1 1/4	50,8	88,0	84,0	4000
1215972	-2024	20	32,0	1 1/4"	24	1 1/2	60,3	91,5	87,5	3000
1215973	-2424	24	38,0	1 1/2"	24	1 1/2	60,3	104,8	91,0	3000
1215974	-2432	24	38,0	1 1/2"	32	2	71,4	104,8	115,0	3000
1215975	-3232	32	51,0	2"	32	2	71,4	129,3	130,0	3000

// C12443610

Flange SAE 6000 PSI J518 Code 62 - SFS

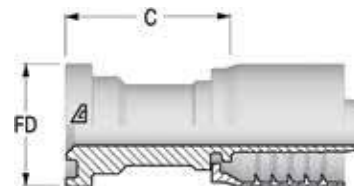

Item Code	Tail/Head	ID		Flange		Flange Size	C	FD	WP
	Dash	Dash	mm	in	Dash Size				
1215977	-0808	08	13,0	1/2"	08	1/2	47,0	31,8	6000
1215978	-0812	08	13,0	1/2"	12	3/4	52,0	41,3	6000
1215979	-1212	12	19,0	3/4"	12	3/4	52,5	41,3	6000
1215980	-1216	12	19,0	3/4"	16	1	55,5	47,6	6000
1215981	-1612	16	25,0	1"	12	3/4	56,4	41,3	6000
1215982	-1616	16	25,0	1"	16	1	56,4	47,6	6000
1215983	-1620	16	25,0	1"	20	1 1/4	63,4	54,0	6000
1215984	-2020	20	32,0	1 1/4"	20	1 1/4	83,0	54,0	6000
1215985	-2024	20	32,0	1 1/4"	24	1 1/2	71,0	63,5	6000
1215986	-2424	24	38,0	1 1/2"	24	1 1/2	101,0	63,5	6000
1215988	-3232	32	51,0	2"	32	2	76,0	79,4	6000

Dimensions shown may be changed without prior notice

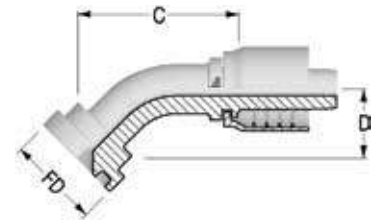
// C12443640**45° Flange SAE 6000 PSI J518 Code 62 - SFS 45
Solid one piece**

Item Code	Tail/Head		ID		Flange		FD	C	D Drop	WP
	Dash	Dash	mm	in	Dash Size	Flange Size				
1215999	-0808	08	13,0	1/2"	08	1/2	31,8	56,5	23,0	6000
1216000	-0812	08	13,0	1/2"	12	3/4	41,3	79,9	30,5	6000
1216001	-1212	12	19,0	3/4"	12	3/4	41,3	84,1	31,0	6000
1216002	-1216	12	19,0	3/4"	16	1	47,6	80,0	33,5	6000
1216003	-1616	16	25,0	1"	16	1	47,6	96,7	36,0	6000
1216004	-1620	16	25,0	1"	20	1 1/4	54,0	96,1	39,0	6000
1216005	-2020	20	32,0	1 1/4"	20	1 1/4	54,0	108,6	40,0	6000
1216006	-2024	20	32,0	1 1/4"	24	1 1/2	63,5	114,8	45,5	6000
1216007	-2424	24	38,0	1 1/2"	24	1 1/2	63,5	122,9	45,0	6000
1216009	-3232	32	51,0	2"	32	2	79,4	156,6	60,0	6000

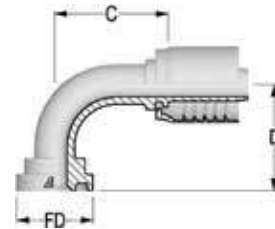
// C12443690**90° Flange SAE 6000 PSI J518 Code 62 - SFS 90
Solid one piece**

Item Code	Tail/Head		ID		Flange		FD	C	D Drop	WP
	Dash	Dash	mm	in	Dash Size	Flange Size				
1216015	-0808	08	13,0	1/2"	08	1/2	31,8	47,8	46,0	6000
1216016	-0812	08	13,0	1/2"	12	3/4	41,3	47,8	54,0	6000
1216017	-1012	10	16,0	5/8"	12	3/4	41,3	49,9	55,0	6000
1216018	-1212	12	19,0	3/4"	12	3/4	41,3	63,2	61,0	6000
1216019	-1216	12	19,0	3/4"	16	1	47,6	63,2	66,0	6000
1216021	-1616	16	25,0	1"	16	1	47,6	73,6	75,0	6000
1216022	-1620	16	25,0	1"	20	1 1/4	54,0	77,6	78,0	6000
1216023	-2020	20	32,0	1 1/4"	20	1 1/4	54,0	94,5	89,0	6000
1216024	-2024	20	32,0	1 1/4"	24	1 1/2	63,5	98,0	94,0	6000
1216025	-2424	24	38,0	1 1/2"	24	1 1/2	63,5	99,6	105,0	6000
1216027	-3232	32	51,0	2"	32	2	79,4	143,3	132,0	6000

// C122 SAE FLANGES

// C12243310

Flange SAE 3000 PSI J518 Code 61 - SFL

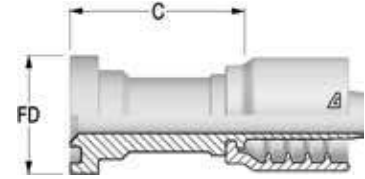

Item Code	Tail/Head	ID		Flange		Flange Size	C	FD	WP
	Dash	Dash	mm	in	Dash Size				
1203199	-4848	48	76,0	3"	48	3	55,0	101,6	2000
1214123	-6464	64	102,0	4"	64	4	130,0	127,0	525

// C12243340

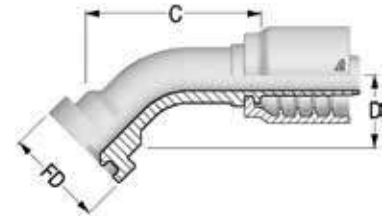
45° Flange SAE 3000 PSI J518 Code 61 - SFL 45
Solid one piece

Item Code	Tail/Head	ID		Flange		FD	C	D Drop	WP
	Dash	Dash	mm	in	Dash Size				
1214132	-4848	48	76,0	3"	48	3	140,0	54,0	2000
1214133	-6464	64	102,0	4"	64	4	264,5	161,0	525

// C12243390

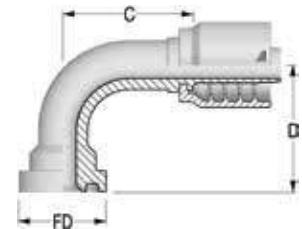
90° Flange SAE 3000 PSI J518 Code 61 - SFL 90
Solid one piece

Item Code	Tail/Head	ID		Flange		FD	C	D Drop	WP
	Dash	Dash	mm	in	Dash Size				
1203198	-4848	48	76,0	3"	48	3	149,3	140,0	2000
1214145	-6464	64	102,0	4"	64	4	187,4	190,0	525



// ALFACRIMP // C126

// JIC 37° INSERTS.....	184	// SAE FLANGES	188
// NPTF INSERTS	185	// SUPERCAT FLANGES.....	190
// API INSERTS	186	// HAMMER UNION	192
// ORFS INSERTS.....	187		

// JIC 37° INSERTS

// C12626512

**JIC Female 37° Seat with Stem Hexagon
DKJ**

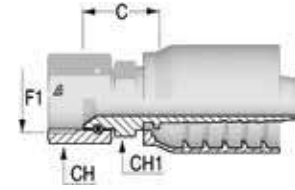

Item Code	Tail/Head	Nut Type	ID			F1	F1	C	CH	CH1
	Dash		Dash	mm	in	Dash Size				
1216077	-1212	TN	12	19,0	3/4"	12	1 1/16-12	30,2	27,0	32,0
1216080	-1616	TN	16	25,0	1"	16	1 5/16-12	38,0	36,0	38,0
1216082	-2020	TN	20	32,0	1 1/4"	20	1 5/8-12	43,1	41,0	50,0
1216084	-2424	TN	24	38,0	1 1/2"	24	1 7/8-12	49,4	50,0	55,0
1216085	-3232	TN	32	51,0	2"	32	2 1/2-12	67,0	65,0	70,0

// C12622542

**45° JIC Female 37° Seat
DKJ 45
Solid one piece**

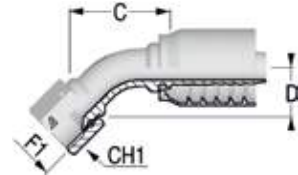

Item Code	Tail/Head	Nut Type	ID			F1	F1	C	D Drop	CH1
	Dash		Dash	mm	in	Dash Size				
1216067	-1212	TN	12	19,0	3/4"	12	1 1/16-12	66,0	27,5	32,0
1216068	-1616	TN	16	25,0	1"	16	1 5/16-12	79,5	31,0	38,0
1216069	-2020	TN	20	32,0	1 1/4"	20	1 5/8-12	93,7	37,0	50,0
1216070	-2424	TN	24	38,0	1 1/2"	24	1 7/8-12	107,0	43,5	55,0

// C12622592

**90° JIC Female 37° Seat
DKJ 90
Solid one piece**

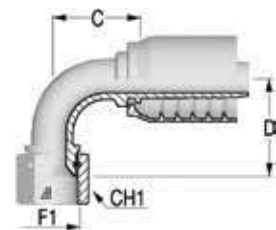

Item Code	Tail/Head	Nut Type	ID			F1	F1	C	D Drop	CH1
	Dash		Dash	mm	in	Dash Size				
1216071	-1212	TN	12	19,0	3/4"	12	1 1/16-12	45,0	57,0	32,0
1216074	-1616	TN	16	25,0	1"	16	1 5/16-12	71,0	67,0	38,0
1216076	-2020	TN	20	32,0	1 1/4"	20	1 5/8-12	79,2	78,0	50,0
1214175	-2424	TN	24	38,0	1 1/2"	24	1 7/8-12	94,5	92,0	55,0

Dimensions shown may be changed without prior notice

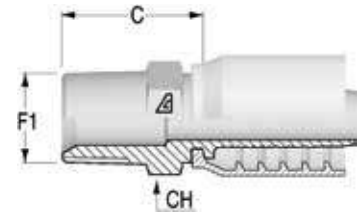
// NPTF INSERTS**// C12612810****NPTF Male 60° Seat
AGN**

Item Code	Tail/Head	Nut Type	ID			F1	F1	C	CH
	Dash		Dash	mm	in	Dash Size			
1216038	-1212	NA	12	19,0	3/4"	12	3/4-14	35,5	27,0
1216039	-1616	NA	16	25,0	1"	16	1-11 1/2	46,5	36,0
1216040	-2020	NA	20	32,0	1 1/4"	20	1 1/4-11 1/2	52,0	46,0
1216041	-2424	NA	24	38,0	1 1/2"	24	1 1/2-11 1/2	55,5	50,0

// API INSERTS

// C1261281Z

API Male

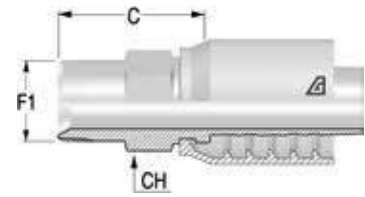

Item Code	Tail/Head	Nut Type	ID			F1	F1	C	CH
	Dash		Dash	mm	in	Dash Size		mm	mm
1216043	-3232	-	32	51,0	2"	32	2-11 1/2	114,5	65,0

Dimensions shown may be changed without prior notice

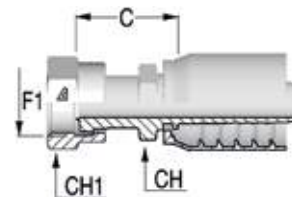
// ORFS INSERTS**// C12622411****ORFS Female with Stem Hexagon**

Item Code	Tail/Head Dash	Nut Type	ID			F1 Dash Size	F1	C mm	CH mm	CH1 mm
			Dash	mm	in					
1214173	-1212	CR	12	19,0	3/4"	12	1 3/16-12	40,0	30,0	36,0
1214174	-1216	CR	12	19,0	3/4"	16	1 7/16-12	43,0	36,0	41,0
1216051	-1616	CR	16	25,0	1"	16	1 7/16-12	47,0	36,0	41,0
1216052	-1620	CR	16	25,0	1"	20	1 11/16-12	49,0	46,0	50,0
1216053	-2020	CR	20	32,0	1 1/4"	20	1 11/16-12	47,2	46,0	50,0

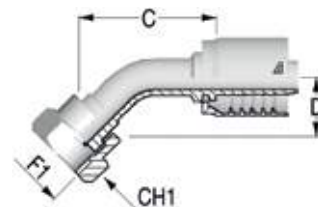
// C12622441**45° ORFS Female
DK ORFS 45
Solid one piece**

Item Code	Tail/Head Dash	Nut Type	ID			F1 Dash Size	F1	C mm	D Drop mm	CH1 mm
			Dash	mm	in					
1216055	-1212	CR	12	19,0	3/4"	12	1 3/16-12	77,7	26,0	36,0
1216056	-1216	CR	12	19,0	3/4"	16	1 7/16-12	68,4	28,0	41,0
1216057	-1616	CR	16	25,0	1"	16	1 7/16-12	114,0	28,0	41,0

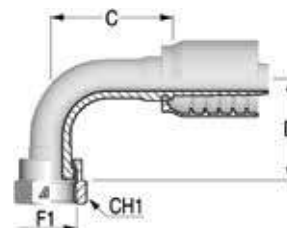
// C12622491**90° ORFS Female
DK ORFS 90
Solid one piece**

Item Code	Tail/Head Dash	Nut Type	ID			F1 Dash Size	F1	C mm	D Drop mm	CH1 mm
			Dash	mm	in					
1216059	-1212	CR	12	19,0	3/4"	12	1 3/16-12	64,2	58,0	36,0
1216060	-1216	CR	12	19,0	3/4"	16	1 7/16-12	66,2	58,0	41,0
1216061	-1616	CR	16	25,0	1"	16	1 7/16-12	75,2	66,0	41,0
1216062	-2020	CR	20	32,0	1 1/4"	20	1 11/16-12	91,7	81,0	50,0

// SAE FLANGES

// C12643310

Flange SAE 3000 PSI J518 Code 61 - SFL

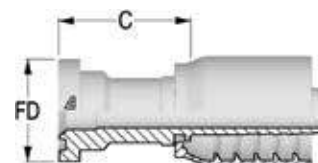

Item Code	Tail/Head	ID		Flange		C	FD	WP	
	Dash	Dash	mm	in	Dash Size				Flange Size
1216086	-1212	12	19,0	3/4"	12	3/4	43,5	38,1	5000
1216087	-1216	12	19,0	3/4"	16	1	51,5	44,5	5000
1216088	-1616	16	25,0	1"	16	1	53,5	44,5	5000
1216089	-1620	16	25,0	1"	20	1 1/4	56,0	50,8	4000
1216091	-2020	20	32,0	1 1/4"	20	1 1/4	58,5	50,8	4000
1216093	-2424	24	38,0	1 1/2"	24	1 1/2	63,5	60,3	3000
1216094	-2432	24	38,0	1 1/2"	32	2	75,0	71,4	3000
1237793	-3232	32	51,0	2"	32	2	85,0	71,4	3000

// C12643610

Flange SAE 6000 PSI J518 Code 62 - SFS

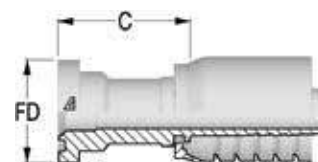

Item Code	Tail/Head	ID		Flange		C	FD	WP	
	Dash	Dash	mm	in	Dash Size				Flange Size
1216120	-1212	12	19,0	3/4"	12	3/4	50,0	41,3	6000
1216121	-1216	12	19,0	3/4"	16	1	53,0	47,6	6000
1216123	-1616	16	25,0	1"	16	1	54,0	47,6	6000
1216124	-1620	16	25,0	1"	20	1 1/4	61,0	54,0	6000
1216125	-2020	20	32,0	1 1/4"	20	1 1/4	62,2	54,0	6000
1216126	-2024	20	32,0	1 1/4"	24	1 1/2	68,2	63,5	6000
1216127	-2424	24	38,0	1 1/2"	24	1 1/2	68,5	63,5	6000
1216128	-2432	24	38,0	1 1/2"	32	2	80,5	79,4	6000

Dimensions shown may be changed without prior notice

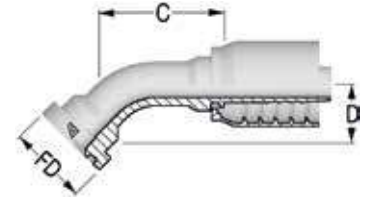
// C12643640**45° Flange SAE 6000 PSI J518 Code 62 - SFS 45
Solid one piece**

Item Code	Tail/Head		ID		Flange		FD	C	D Drop	WP
	Dash	Dash	mm	in	Dash Size	Flange Size				
1216140	-1212	12	19,0	3/4"	12	3/4	41,3	72,1	30,0	6000
1216141	-1216	12	19,0	3/4"	16	1	47,6	76,8	33,0	6000
1216142	-1616	16	25,0	1"	16	1	47,6	94,8	38,5	6000
1216143	-1620	16	25,0	1"	20	1 1/4	54,0	105,3	44,0	6000
1216144	-2020	20	32,0	1 1/4"	20	1 1/4	54,0	102,0	41,0	6000
1216145	-2024	20	32,0	1 1/4"	24	1 1/2	63,5	111,7	48,0	6000
1216146	-2424	24	38,0	1 1/2"	24	1 1/2	63,5	136,3	48,0	6000
1216147	-2432	24	38,0	1 1/2"	32	2	79,4	129,1	55,0	6000

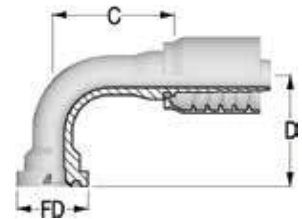
// C12643690**90° Flange SAE 6000 PSI J518 Code 62 - SFS 90
Solid one piece**

Item Code	Tail/Head		ID		Flange		FD	C	D Drop	WP
	Dash	Dash	mm	in	Dash Size	Flange Size				
1216154	-1212	12	19,0	3/4"	12	3/4	41,3	61,2	64,0	6000
1216155	-1216	12	19,0	3/4"	16	1	47,6	61,2	66,0	6000
1216157	-1616	16	25,0	1"	16	1	47,6	70,4	74,0	6000
1216158	-1620	16	25,0	1"	20	1 1/4	54,0	77,2	85,0	6000
1216159	-2020	20	32,0	1 1/4"	20	1 1/4	54,0	88,2	91,0	6000
1216160	-2024	20	32,0	1 1/4"	24	1 1/2	63,5	92,9	103,5	6000
1216161	-2420	24	38,0	1 1/2"	20	1 1/4	54,0	105,0	85,0	6000
1216162	-2424	24	38,0	1 1/2"	24	1 1/2	63,5	106,3	109,0	6000
1216163	-2432	24	38,0	1 1/2"	32	2	79,4	106,5	121,5	6000

// SUPERCAT FLANGES

// C12643910

Flange SUPERCAT

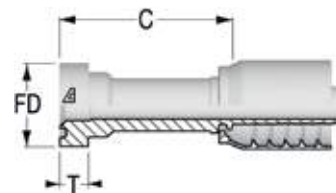

Item Code	Tail/Head	ID	Flange		FD	T	C		
	Dash		Dash	mm				in	Dash Size
1216165	-1212	12	19,0	3/4"	12	3/4	41,3	14,3	82,0
1216166	-1216	12	19,0	3/4"	16	1	47,6	14,3	82,0
1216167	-1616	16	25,0	1"	16	1	47,6	14,3	90,0
1216168	-1620	16	25,0	1"	20	1 1/4	54,0	14,3	90,0
1216169	-2020	20	32,0	1 1/4"	20	1 1/4	54,0	14,3	86,2
1216170	-2424	24	38,0	1 1/2"	24	1 1/2	63,5	14,3	89,0

// C12643930

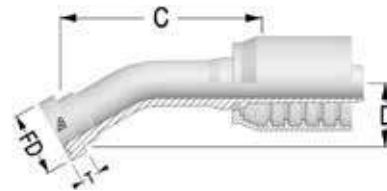
30° Flange SUPERCAT
Solid one piece

Item Code	Tail/Head	ID	Flange		FD	T	C	D Drop		
	Dash		Dash	mm					in	Dash Size
1216173	-1212	12	19,0	3/4"	12	3/4	41,3	14,3	115,0	24,0
1216174	-1216	12	19,0	3/4"	16	1	47,6	14,3	118,0	26,5
1233049	-1616	16	25,0	1"	16	1	47,6	14,3	139,0	27,0
1233050	-1620	16	25,0	1"	20	1 1/4	54,0	14,3	137,0	25,5

// C12643940

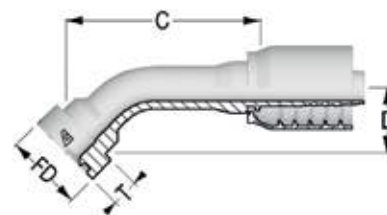
45° Flange SUPERCAT
Solid one piece

Item Code	Tail/Head	ID	Flange		FD	T	C	D Drop		
	Dash		Dash	mm					in	Dash Size
1216177	-1212	12	19,0	3/4"	12	3/4	41,3	14,3	103,0	33,7
1216178	-1216	12	19,0	3/4"	16	1	47,6	14,3	87,4	35,8
1216179	-1616	16	25,0	1"	16	1	47,6	14,3	93,9	42,5
1216180	-1620	16	25,0	1"	20	1 1/4	54,0	14,3	95,4	40,0
1216181	-2020	20	32,0	1 1/4"	20	1 1/4	54,0	14,3	103,6	45,1
1245063	-3232	32	51,0	2"	32	2	79,4	-	179,0	63,0

Dimensions shown may be changed without prior notice

// C12643960

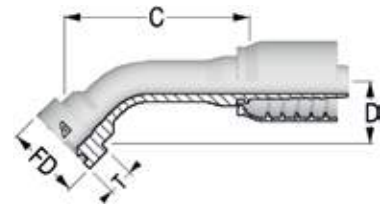
60° Flange SUPERCAT
Solid one piece

Item Code	Tail/Head		ID		Flange		FD	T	C	D Drop
	Dash	Dash	mm	in	Dash Size	Flange Size				
1216182	-1212	12	19,0	3/4"	12	3/4	41,3	14,3	92,6	46,0
1216183	-1216	12	19,0	3/4"	16	1	47,6	14,3	95,6	48,5
1216184	-1616	16	25,0	1"	16	1	47,6	14,3	118,0	59,0
1216185	-1620	16	25,0	1"	20	1 1/4	54,0	14,3	118,0	57,0

// C12643970

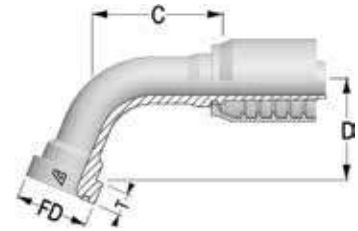
67,5° Flange SUPERCAT
Solid one piece

Item Code	Tail/Head		ID		Flange		FD	T	C	D Drop
	Dash	Dash	mm	in	Dash Size	Flange Size				
1216193	-1212	12	19,0	3/4"	12	3/4	41,3	14,3	86,1	51,8
1216194	-1216	12	19,0	3/4"	16	1	47,6	14,3	88,8	54,6
1233051	-1616	16	25,0	1"	16	1	47,6	14,3	111,0	67,0
1233052	-1620	16	25,0	1"	20	1 1/4	54,0	14,3	109,0	64,0
1233053	-2020	20	32,0	1 1/4"	20	1 1/4	54,0	14,3	119,3	70,6

// C12643990

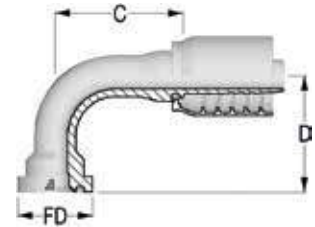
90° Flange SUPERCAT
Solid one piece

Item Code	Tail/Head		ID		Flange		FD	T	C	D Drop
	Dash	Dash	mm	in	Dash Size	Flange Size				
1216188	-1212	12	19,0	3/4"	12	3/4	41,3	14,3	63,7	67,0
1216189	-1216	12	19,0	3/4"	16	1	47,6	14,3	65,2	70,0
1216190	-1616	16	25,0	1"	16	1	47,6	14,3	80,4	79,0
1216192	-1620	16	25,0	1"	20	1 1/4	54,0	14,3	75,4	82,5
1233054	-2020	20	32,0	1 1/4"	20	1 1/4	54,0	14,3	89,2	93,0
1245064	-3232	32	51,0	2"	32	2	79,4	-	152,0	138,5

// HAMMER UNION

// C12R13F13

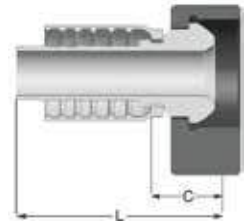
Male Hammer Union Fig. 1502 Integral Fitting with Lug Nut

Item Code	Tail/Head	Dash	ID		C	L
	Dash		mm	in	mm	mm

// C12R23F10

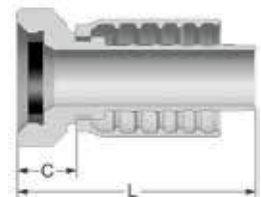
Female Hammer Union Fig. 1502 Integral Fitting with Rubber Ring

Item Code	Tail/Head	Dash	ID		C	L
	Dash		mm	in	mm	mm



// JIC 37° ADAPTERS

// MALE UNION.....	194	// SAE UNF	218
// MALE / FEMALE UNION	196	// NPTF	226
// BULKHEAD.....	199	// FLANGES	229
// BSPP	202	// ACCESSORIES.....	232
// METRIC.....	212	// PLUG	233

// MALE UNION

// R1A25M125M

Straight union JIC - JIC Male

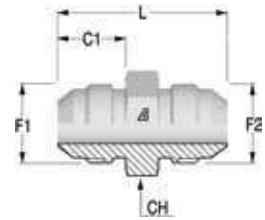

Item Code	Head 1 / Head 2	OD1	F1	C1	CH	L
	Dash	in		mm	mm	
1203685	-0404	1/4"	7/16-20	14,0	12,0	35,0
1203628	-0505	5/16"	1/2-20	14,0	14,0	35,0
1203713	-0606	3/8"	9/16-18	14,0	17,0	36,0
1203670	-0808	1/2"	3/4-16	16,5	22,0	41,0
1203698	-1010	5/8"	7/8-14	19,5	24,0	48,0
1203616	-1212	3/4"	1 1/16-12	22,0	30,0	55,0
1216393	-1414	7/8"	1 3/16-12	22,5	32,0	56,5
1203639	-1616	1"	1 5/16-12	23,0	36,0	57,0
1203646	-2020	1 1/4"	1 5/8-12	24,5	46,0	61,5
1203653	-2424	1 1/2"	1 7/8-12	27,5	50,0	70,0

// R1A25M925M

90° union JIC - JIC Male

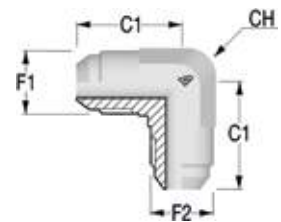

Item Code	Head 1 / Head 2	OD1	F1	C1	CH
	Dash	in		mm	mm
1203876	-0404	1/4"	7/16-20	22,5	12,0
1203842	-0505	5/16"	1/2-20	24,0	14,0
1203897	-0606	3/8"	9/16-18	27,0	14,0
1203866	-0808	1/2"	3/4-16	32,0	19,0
1203884	-1010	5/8"	7/8-14	37,0	22,0
1203836	-1212	3/4"	1 1/16-12	42,0	27,0
1216421	-1414	7/8"	1 3/16-12	44,0	33,0
1203849	-1616	1"	1 5/16-12	46,0	33,0
1203855	-2020	1 1/4"	1 5/8-12	52,5	41,0
1206334	-2424	1 1/2"	1 7/8-12	59,0	48,0

Dimensions shown may be changed without prior notice

// R1A25MT25M

Tee union JIC - JIC Male

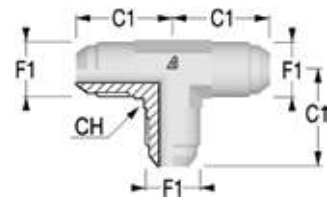

Item Code	Head 1 / Head 2	OD1	F1	C1	CH
	Dash	in		mm	mm
1203950	-0404	1/4"	7/16-20	22,5	12,0
1203945	-0505	5/16"	1/2-20	24,0	14,0
1203954	-0606	3/8"	9/16-18	27,0	14,0
1203948	-0808	1/2"	3/4-16	32,0	19,0
1203952	-1010	5/8"	7/8-14	37,0	22,0
1203944	-1212	3/4"	1 1/16-12	42,0	27,0
1216460	-1414	7/8"	1 3/16-12	44,0	33,0
1203947	-1616	1"	1 5/16-12	46,0	33,0
1205959	-2020	1"1/4	1 5/8-12	52,5	41,0
1206335	-2424	1"1/2	1 7/8-12	59,0	48,0

// R1A25MX25M

Cross union JIC - JIC Male

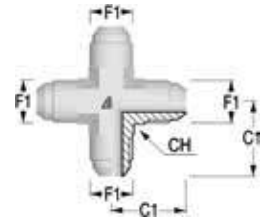

Item Code	Head 1 / Head 2	OD1	F1	C1	CH
	Dash	in		mm	mm
1206909	-0404	1/4"	7/16-20	22,5	12,0
1205451	-0505	5/16"	1/2-20	24,0	14,0
1205455	-0606	3/8"	9/16-18	27,0	14,0
1205453	-0808	1/2"	3/4-16	32,0	19,0
1205454	-1010	5/8"	7/8-14	37,0	22,0
1206835	-1212	3/4"	1 1/16-12	42,0	27,0
1216494	-1414	7/8"	1 3/16-12	44,0	33,0
1205452	-1616	1"	1 5/16-12	46,0	33,0
1212823	-2020	1"1/4	1 5/8-12	52,5	41,0
1212824	-2424	1"1/2	1 7/8-12	59,0	48,0

// MALE / FEMALE UNION

// R1A253125M

Straight reducing JIC Female - JIC Male

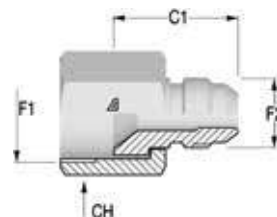

Item Code	Head 1 / Head 2	OD1 in	F1	F2	C1 mm	CH mm
	Dash					
1207357	-0604	3/8"	9/16-18	7/16-20	25,0	19,0
1207615	-0605	3/8"	9/16-18	1/2-20	25,0	19,0
1207358	-0804	1/2"	3/4-16	7/16-20	25,5	22,0
1207359	-0805	1/2"	3/4-16	1/2-20	25,5	22,0
1207360	-0806	1/2"	3/4-16	9/16-18	25,5	22,0
1207361	-1004	5/8"	7/8-14	7/16-20	26,5	27,0
1207362	-1006	5/8"	7/8-14	9/16-18	26,5	27,0
1207616	-1008	5/8"	7/8-14	3/4-16	29,0	27,0
1207363	-1204	3/4"	1 1/16-12	7/16-20	27,0	32,0
1207364	-1206	3/4"	1 1/16-12	9/16-18	27,0	32,0
1207365	-1208	3/4"	1 1/16-12	3/4-16	30,5	32,0
1207617	-1210	3/4"	1 1/16-12	7/8-14	34,5	32,0
1216344	-1412	7/8"	1 3/16-12	1 1/16-12	36,4	36,0
1216365	-1606	1"	1 5/16-12	9/16-18	28,5	41,0
1216366	-1608	1"	1 5/16-12	3/4-16	31,0	41,0
1208272	-1610	1"	1 5/16-12	7/8-14	34,0	41,0
1207367	-1612	1"	1 5/16-12	1 1/16-12	37,5	41,0
1213168	-1614	1"	1 5/16-12	1 3/16-12	39,5	38,0
1207366	-2012	1 1/4"	1 5/8-12	1 1/16-12	39,1	50,0
1207368	-2016	1 1/4"	1 5/8-12	1 5/16-12	40,0	50,0
1216367	-2416	1 1/2"	1 7/8-12	1 5/16-12	46,3	60,0
1207369	-2420	1 1/2"	1 7/8-12	1 5/8-12	47,8	60,0

// R1A25M4251

45° union JIC Male - JIC Female

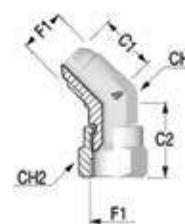

Item Code	Head 1 / Head 2	OD1 in	F1	C1	C2	CH mm	CH2 mm
	Dash			mm	mm		
1207343	-0404	1/4"	7/16-20	18,5	23,7	12,0	16,0
1207342	-0505	5/16"	1/2-20	19,5	25,5	14,0	17,0
1207341	-0606	3/8"	9/16-18	21,5	28,5	14,0	19,0
1207344	-0808	1/2"	3/4-16	24,5	32,7	19,0	25,0
1206944	-1010	5/8"	7/8-14	28,0	36,7	22,0	27,0
1207345	-1212	3/4"	1 1/16-12	32,5	38,3	27,0	32,0
1216410	-1414	7/8"	1 3/16-12	35,4	41,1	33,0	36,0
1207346	-1616	1"	1 5/16-12	36,5	44,6	33,0	38,0
1207347	-2020	1 1/4"	1 5/8-12	40,5	51,4	41,0	50,0
1210765	-2424	1 1/2"	1 7/8-12	45,0	57,1	48,0	55,0

Dimensions shown may be changed without prior notice

// R1A25M9251

90° union JIC Male - JIC Female

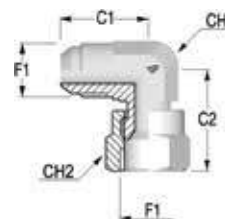

Item Code	Head 1 / Head 2	OD1	F1	C1	C2	CH	CH2
	Dash	in		mm	mm	mm	mm
1207266	-0404	1/4"	7/16-20	22,5	25,2	12,0	16,0
1207267	-0505	5/16"	1/2-20	24,0	27,0	14,0	17,0
1207268	-0606	3/8"	9/16-18	27,0	32,0	14,0	19,0
1207269	-0808	1/2"	3/4-16	32,0	35,2	19,0	25,0
1207270	-1010	5/8"	7/8-14	36,5	41,5	22,0	27,0
1207271	-1212	3/4"	1 1/16-12	42,0	44,3	27,0	32,0
1216420	-1414	7/8"	1 3/16-12	45,5	46,5	33,0	36,0
1207272	-1616	1"	1 5/16-12	46,0	50,5	33,0	38,0
1207273	-2020	1 1/4"	1 5/8-12	52,5	58,9	41,0	50,0
1207274	-2424	1 1/2"	1 7/8-12	59,0	65,6	48,0	55,0

// R1A25MT251

Branch Tee union JIC Male - JIC Female

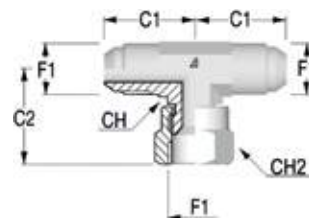

Item Code	Head 1 / Head 2	OD1	F1	C1	C2	CH	CH2
	Dash	in		mm	mm	mm	mm
1207304	-0404	1/4"	7/16-20	22,5	22,5	12,0	16,0
1207305	-0505	5/16"	1/2-20	24,0	24,0	14,0	17,0
1207306	-0606	3/8"	9/16-18	27,0	27,0	14,0	19,0
1207307	-0808	1/2"	3/4-16	32,0	32,0	19,0	25,0
1207308	-1010	5/8"	7/8-14	36,5	36,5	22,0	27,0
1207309	-1212	3/4"	1 1/16-12	42,0	42,0	27,0	32,0
1216459	-1414	7/8"	1 3/16-12	45,5	45,5	33,0	36,0
1207310	-1616	1"	1 5/16-12	46,0	46,0	33,0	38,0
1207311	-2020	1 1/4"	1 5/8-12	52,5	52,5	41,0	50,0
1207312	-2424	1 1/2"	1 7/8-12	59,0	59,0	48,0	55,0

// R1A25ML251

Run Tee union JIC Male - JIC Female

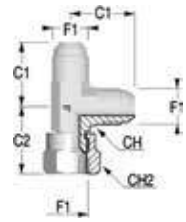

Item Code	Head 1 / Head 2	OD1	F1	C1	C2	CH	CH2
	Dash	in		mm	mm	mm	mm
1207283	-0404	1/4"	7/16-20	22,5	25,2	12,0	16,0
1207284	-0505	5/16"	1/2-20	24,0	27,0	14,0	17,0
1207285	-0606	3/8"	9/16-18	27,0	32,0	14,0	19,0
1207286	-0808	1/2"	3/4-16	32,0	35,2	19,0	25,0
1207287	-1010	5/8"	7/8-14	36,5	41,5	22,0	27,0
1207288	-1212	3/4"	1 1/16-12	42,0	44,3	27,0	32,0
1216434	-1414	7/8"	1 3/16-12	45,5	46,5	33,0	36,0
1207289	-1616	1"	1 5/16-12	46,0	50,5	33,0	38,0
1207290	-2020	1*1/4	1 5/8-12	52,5	58,9	41,0	50,0
1207291	-2424	1*1/2	1 7/8-12	59,0	65,6	48,0	55,0

Dimensions shown may be changed without prior notice

// BULKHEAD

// R1A25M125T

Straight union JIC - JIC Bulkhead

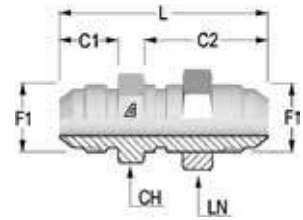

Item Code	Head 1 / Head 2	OD1 in	F1	C1 mm	C2 mm	CH mm	LN mm	L mm
	Dash							
1203686	-0404	1/4"	7/16-20	14,0	30,5	17,0	17,0	52,5
1203629	-0505	5/16"	1/2-20	14,0	30,5	19,0	19,0	52,5
1203714	-0606	3/8"	9/16-18	14,0	32,5	22,0	22,0	55,5
1203671	-0808	1/2"	3/4-16	16,5	36,6	24,0	24,0	62,0
1203699	-1010	5/8"	7/8-14	19,5	40,1	30,0	30,0	69,5
1203617	-1212	3/4"	1 1/16-12	22,0	44,4	36,0	36,0	78,5
1216394	-1414	7/8"	1 3/16-12	22,5	44,4	38,0	38,0	79,2
1203640	-1616	1"	1 5/16-12	23,0	44,4	41,0	41,0	80,0
1203647	-2020	1 1/4"	1 5/8-12	24,5	45,7	50,0	50,0	84,0
1211675	-2424	1 1/2"	1 7/8-12	27,5	46,0	55,0	55,0	89,5

// R1A25M425T

45° union JIC - JIC Bulkhead

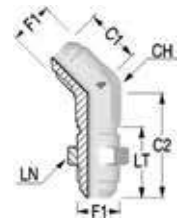

Item Code	Head 1 / Head 2	OD1 in	F1	C1 mm	C2 mm	CH mm	LN mm	LT mm
	Dash							
1210766	-0404	1/4"	7/16-20	18,5	39,0	12,0	17,0	30,5
1211706	-0505	5/16"	1/2-20	19,5	42,0	14,0	19,0	30,5
1208045	-0606	3/8"	9/16-18	21,0	42,5	14,0	22,0	32,5
1210767	-0808	1/2"	3/4-16	25,0	49,5	19,0	24,0	36,6
1210768	-1010	5/8"	7/8-14	28,0	55,0	22,0	30,0	40,1
1210769	-1212	3/4"	1 1/16-12	32,5	62,0	27,0	36,0	44,4
1216411	-1414	7/8"	1 3/16-12	35,0	63,5	33,0	38,0	44,4
1210770	-1616	1"	1 5/16-12	37,5	65,0	33,0	41,0	44,4
1211707	-2020	1 1/4"	1 5/8-12	40,5	67,5	41,0	50,0	45,7
1211708	-2424	1 1/2"	1 7/8-12	45,0	68,0	48,0	55,0	46,0

// R1A25M925T

90° union JIC - JIC Bulkhead

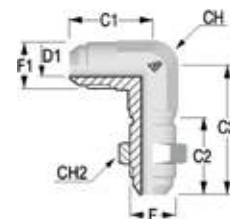

Item Code	Head 1 / Head 2	OD1	F1	C1	C2	CH	LN	LT
	Dash			in	mm	mm		
1205564	-0404	1/4"	7/16-20	24,5	40,5	12,0	17,0	30,5
1206405	-0505	5/16"	1/2-20	27,0	43,5	14,0	19,0	30,5
1203898	-0606	3/8"	9/16-18	27,5	46,0	14,0	22,0	32,5
1203867	-0808	1/2"	3/4-16	34,5	53,5	19,0	24,0	36,6
1203885	-1010	5/8"	7/8-14	39,5	60,5	22,0	30,0	40,1
1206783	-1212	3/4"	1 1/16-12	45,0	68,0	27,0	36,0	44,4
1216422	-1414	7/8"	1 3/16-12	47,0	69,0	33,0	38,0	44,4
1211735	-1616	1"	1 5/16-12	49,5	71,0	33,0	41,0	44,4
1211736	-2020	1 1/4"	1 5/8-12	55,0	79,0	41,0	50,0	45,7
1208117	-2424	1 1/2"	1 7/8-12	59,5	87,0	48,0	55,0	46,0

// R1A25MT25T

Branch Tee union JIC - JIC Bulkhead

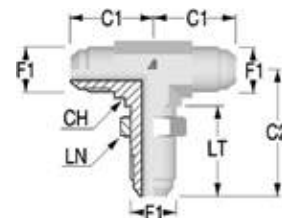

Item Code	Head 1 / Head 2	OD1	F1	C1	C2	CH	LN	LT
	Dash			in	mm	mm		
1208139	-0404	1/4"	7/16-20	24,5	40,5	12,0	17,0	30,5
1210747	-0505	5/16"	1/2-20	27,0	43,5	14,0	19,0	30,5
1210748	-0606	3/8"	9/16-18	27,5	46,0	14,0	22,0	32,5
1205586	-0808	1/2"	3/4-16	34,5	53,5	19,0	24,0	36,6
1211637	-1010	5/8"	7/8-14	39,5	60,5	22,0	30,0	40,1
1211638	-1212	3/4"	1 1/16-12	45,0	68,0	27,0	36,0	44,4
1216462	-1414	7/8"	1 3/16-12	47,0	69,0	33,0	38,0	44,4
1212775	-1616	1"	1 5/16-12	49,5	71,0	33,0	41,0	44,4
1208225	-2020	1 1/4"	1 5/8-12	55,0	79,0	41,0	50,0	45,7
1212776	-2424	1 1/2"	1 7/8-12	59,5	87,0	48,0	55,0	46,0

Dimensions shown may be changed without prior notice

// R1A25ML25T

Run Tee union JIC - JIC Bulkhead

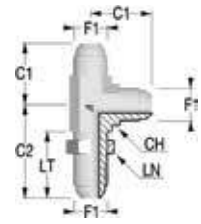

Item Code	Head 1 / Head 2	OD1	F1	C1	C2	CH	LN	LT
	Dash	in		mm	mm	mm	mm	mm
1211617	-0404	1/4"	7/16-20	24,5	40,5	12,0	17,0	30,5
1211618	-0505	5/16"	1/2-20	27,0	43,5	14,0	19,0	30,5
1206974	-0606	3/8"	9/16-18	27,5	46,0	14,0	22,0	32,5
1211619	-0808	1/2"	3/4-16	34,5	53,5	19,0	24,0	36,6
1210743	-1010	5/8"	7/8-14	39,5	60,5	22,0	30,0	40,1
1211620	-1212	3/4"	1 1/16-12	45,0	68,0	27,0	36,0	44,4
1216435	-1414	7/8"	1 3/16-12	47,0	69,0	33,0	38,0	44,4
1212713	-1616	1"	1 5/16-12	49,5	71,0	33,0	41,0	44,4
1212714	-2020	1"1/4	1 5/8-12	55,0	79,0	41,0	50,0	45,7
1212715	-2424	1"1/2	1 7/8-12	59,5	87,0	48,0	55,0	46,0

// BSPP

// R1A25M105M

Straight connector JIC Male - BSPP cylindric Male 60°

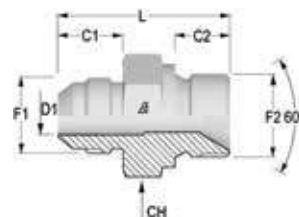

Item Code	Head 1 / Head 2	OD1 in	F1	F2	C1	C2	CH mm	L mm
	Dash				mm	mm		
1212826	-0402	1/4"	7/16-20	1/8-28	14,0	9,5	14,0	29,0
1212827	-0404	1/4"	7/16-20	1/4-19	14,0	13,0	19,0	34,0
1212828	-0406	1/4"	7/16-20	3/8-19	14,0	15,5	22,0	35,5
1212829	-0408	1/4"	7/16-20	1/2-14	14,0	17,0	27,0	40,0
1212830	-0502	5/16"	1/2-20	1/8-28	14,0	9,5	14,0	29,0
1212831	-0504	5/16"	1/2-20	1/4-19	14,0	13,0	19,0	32,0
1212832	-0604	3/8"	9/16-18	1/4-19	14,0	13,0	19,0	34,0
1212833	-0606	3/8"	9/16-18	3/8-19	14,0	15,5	22,0	35,5
1212834	-0608	3/8"	9/16-18	1/2-14	14,0	17,0	27,0	41,0
1212835	-0804	1/2"	3/4-16	1/4-19	16,5	13,0	19,0	36,0
1207735	-0806	1/2"	3/4-16	3/8-19	16,5	15,5	22,0	38,0
1207736	-0808	1/2"	3/4-16	1/2-14	16,5	17,0	27,0	41,0
1207737	-0812	1/2"	3/4-16	3/4-14	16,5	20,0	32,0	45,5
1207738	-1006	5/8"	7/8-14	3/8-19	19,5	15,5	24,0	41,5
1205996	-1008	5/8"	7/8-14	1/2-14	19,5	17,0	27,0	45,5
1231525	-1012	5/8"	7/8-14	3/4-14	19,5	20,0	32,0	48,5
1212837	-1208	3/4"	1 1/16-12	1/2-14	22,0	17,0	32,0	50,0
1212838	-1212	3/4"	1 1/16-12	3/4-14	22,0	20,0	32,0	50,0
1212839	-1216	3/4"	1 1/16-12	1-11	22,0	18,0	41,0	53,0
1216372	-1412	7/8"	1 3/16-12	3/4-14	22,5	20,0	32,0	51,5
1212840	-1612	1"	1 5/16-12	3/4-14	23,0	20,0	36,0	55,0
1212841	-1616	1"	1 5/16-12	1-11	23,0	22,0	41,0	54,0
1212842	-1620	1"	1 5/16-12	1 1/4-11	23,0	23,0	50,0	56,0
1207739	-2016	1 1/4"	1 5/8-12	1-11	24,5	22,0	46,0	58,5
1212843	-2020	1 1/4"	1 5/8-12	1 1/4-11	24,5	23,0	50,0	59,5
1212844	-2420	1 1/2"	1 7/8-12	1 1/4-11	27,5	23,0	50,0	62,5
1212845	-2424	1 1/2"	1 7/8-12	1 1/2-11	27,5	25,0	55,0	67,5

Dimensions shown may be changed without prior notice

// R1A25M106I

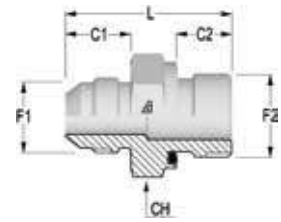
Straight connector JIC Male - BSPP cylindric Male with elastomer

Item Code	Head 1 / Head 2	OD1 in	F1	F2	C1	C2	CH mm	L mm
	Dash				mm	mm		
1207410	-0402	1/4"	7/16-20	1/8-28	14,0	8,0	14,0	30,0
1207411	-0404	1/4"	7/16-20	1/4-19	14,0	12,0	19,0	36,0
1207412	-0406	1/4"	7/16-20	3/8-19	14,0	12,0	22,0	35,5
1207413	-0408	1/4"	7/16-20	1/2-14	14,0	14,0	27,0	39,0
1207993	-0502	5/16"	1/2-20	1/8-28	14,0	8,0	14,0	30,5
1207414	-0504	5/16"	1/2-20	1/4-19	14,0	12,0	19,0	35,0
1207415	-0506	5/16"	1/2-20	3/8-19	14,0	12,0	22,0	35,5
1207416	-0604	3/8"	9/16-18	1/4-19	14,0	12,0	19,0	35,0
1207417	-0606	3/8"	9/16-18	3/8-19	14,0	12,0	22,0	36,0
1207418	-0608	3/8"	9/16-18	1/2-14	14,0	14,0	27,0	39,5
1207419	-0804	1/2"	3/4-16	1/4-19	16,5	12,0	19,0	38,5
1207420	-0806	1/2"	3/4-16	3/8-19	16,5	12,0	22,0	38,5
1207421	-0808	1/2"	3/4-16	1/2-14	16,5	14,0	27,0	42,0
1207422	-0812	1/2"	3/4-16	3/4-14	16,5	17,0	32,0	45,5
1207423	-1006	5/8"	7/8-14	3/8-19	19,5	12,0	24,0	42,5
1207424	-1008	5/8"	7/8-14	1/2-14	19,5	14,0	27,0	44,5
1207425	-1012	5/8"	7/8-14	3/4-14	19,5	17,0	32,0	49,5
1207426	-1208	3/4"	1 1/16-12	1/2-14	22,0	14,0	32,0	49,0
1207427	-1212	3/4"	1 1/16-12	3/4-14	22,0	17,0	32,0	51,0
1207428	-1216	3/4"	1 1/16-12	1-11	22,0	18,0	41,0	53,5
1212875	-1412	7/8"	1 3/16-12	3/4-14	22,5	17,0	32,0	53,5
1207429	-1612	1"	1 5/16-12	3/4-14	23,0	17,0	36,0	51,5
1207430	-1616	1"	1 5/16-12	1-11	23,0	18,0	41,0	54,5
1207431	-1620	1"	1 5/16-12	1 1/4-11	23,0	20,0	50,0	58,4
1208006	-2016	1"1/4	1 5/8-12	1-11	24,5	18,0	46,0	62,0
1207432	-2020	1"1/4	1 5/8-12	1 1/4-11	24,5	20,0	50,0	60,0
1207433	-2420	1"1/2	1 7/8-12	1 1/4-11	27,5	20,0	50,0	64,0
1207434	-2424	1"1/2	1 7/8-12	1 1/2-11	27,5	22,0	55,0	67,0

// R1A25M106H

Long connector JIC Male - BSPP cylindric Male with elastomer

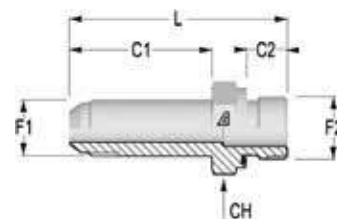

Item Code	Head 1 / Head 2	OD1 in	F1	F2	C1	C2	CH mm	L mm
	Dash				mm	mm		
1212846	-0402	1/4"	7/16-20	1/8-28	35,0	8,0	14,0	50,0
1212847	-0404	1/4"	7/16-20	1/4-19	35,0	12,0	19,0	55,5
1212848	-0406	1/4"	7/16-20	3/8-19	35,0	12,0	22,0	56,8
1212849	-0408	1/4"	7/16-20	1/2-14	35,0	14,0	27,0	60,3
1212850	-0502	5/16"	1/2-20	1/8-28	37,0	8,0	14,0	53,3
1212851	-0504	5/16"	1/2-20	1/4-19	37,0	12,0	19,0	57,5
1212852	-0506	5/16"	1/2-20	3/8-19	37,0	12,0	22,0	57,5
1212853	-0604	3/8"	9/16-18	1/4-19	39,0	12,0	19,0	59,5
1212854	-0606	3/8"	9/16-18	3/8-19	39,0	12,0	22,0	59,5
1212855	-0608	3/8"	9/16-18	1/2-14	39,0	14,0	27,0	63,0
1212856	-0804	1/2"	3/4-16	1/4-19	48,0	12,0	19,0	68,5
1212857	-0806	1/2"	3/4-16	3/8-19	48,0	12,0	22,0	68,5
1212858	-0808	1/2"	3/4-16	1/2-14	48,0	14,0	27,0	72,0
1212859	-0812	1/2"	3/4-16	3/4-14	48,0	17,0	32,0	77,0
1212860	-1006	5/8"	7/8-14	3/8-19	53,0	12,0	24,0	74,0
1212861	-1008	5/8"	7/8-14	1/2-14	53,0	14,0	27,0	77,0
1212862	-1012	5/8"	7/8-14	3/4-14	53,0	17,0	32,0	81,0
1212863	-1208	3/4"	1 1/16-12	1/2-14	63,0	14,0	32,0	88,0
1212864	-1212	3/4"	1 1/16-12	3/4-14	63,0	17,0	32,0	91,0
1212865	-1216	3/4"	1 1/16-12	1-11	63,0	18,0	41,0	93,5
1216388	-1412	7/8"	1 3/16-12	3/4-14	67,0	17,0	32,0	99,3
1212866	-1612	1"	1 5/16-12	3/4-14	72,0	17,0	36,0	100,0
1212867	-1616	1"	1 5/16-12	1-11	72,0	18,0	41,0	102,0
1212868	-1620	1"	1 5/16-12	1 1/4-11	72,0	20,0	50,0	106,0
1212869	-2016	1"1/4	1 5/8-12	1-11	88,0	18,0	46,0	119,0
1212870	-2020	1"1/4	1 5/8-12	1 1/4-11	88,0	20,0	50,0	122,0
1212871	-2420	1"1/2	1 7/8-12	1 1/4-11	98,0	20,0	50,0	132,0
1212872	-2424	1"1/2	1 7/8-12	1 1/2-11	98,0	22,0	55,0	136,0

Dimensions shown may be changed without prior notice

// R1A25M406N

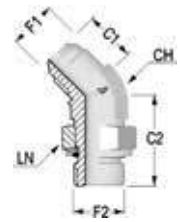
45° adjustable elbow connector JIC Male - BSPP cylindric Male with O-Ring and retaining ring

Item Code	Head 1 / Head 2	OD1 in	F1	F2	C1	C2	CH mm	LN mm
	Dash				mm	mm		
1207325	-0402	1/4"	7/16-20	1/8-28	19,5	26,5	12,0	14,0
1207326	-0404	1/4"	7/16-20	1/4-19	21,0	29,0	14,0	19,0
1212959	-0406	1/4"	7/16-20	3/8-19	22,0	33,0	17,0	22,0
1212960	-0408	1/4"	7/16-20	1/2-14	22,5	38,5	22,0	27,0
1212961	-0502	5/16"	1/2-20	1/8-28	19,5	26,5	14,0	14,0
1211702	-0504	5/16"	1/2-20	1/4-19	19,5	26,5	14,0	19,0
1212962	-0506	5/16"	1/2-20	3/8-19	21,0	32,5	17,0	22,0
1207327	-0604	3/8"	9/16-18	1/4-19	21,0	29,0	14,0	19,0
1207328	-0606	3/8"	9/16-18	3/8-19	22,0	33,0	17,0	22,0
1212963	-0608	3/8"	9/16-18	1/2-14	22,5	38,5	22,0	27,0
1212964	-0804	1/2"	3/4-16	1/4-19	25,0	30,0	19,0	19,0
1207329	-0806	1/2"	3/4-16	3/8-19	25,0	33,0	19,0	22,0
1207330	-0808	1/2"	3/4-16	1/2-14	25,5	38,5	22,0	27,0
1207331	-1008	5/8"	7/8-14	1/2-14	28,0	38,5	22,0	27,0
1208292	-1012	5/8"	7/8-14	3/4-14	30,0	44,0	27,0	36,0
1207333	-1212	3/4"	1 1/16-12	3/4-14	32,5	44,0	27,0	36,0
1212967	-1216	3/4"	1 1/16-12	1-11	37,0	47,0	33,0	41,0
1212968	-1412	7/8"	1 3/16-12	3/4-14	35,0	45,5	33,0	36,0
1212969	-1612	1"	1 5/16-12	3/4-14	37,0	47,0	33,0	36,0
1207334	-1616	1"	1 5/16-12	1-11	37,0	47,0	33,0	41,0
1208380	-2020	1 1/4"	1 5/8-12	1 1/4-11	39,5	48,5	41,0	50,0
1211703	-2424	1 1/2"	1 7/8-12	1 1/2-11	45,0	48,0	48,0	55,0

// R1A25M906N

90° adjustable elbow connector JIC Male - BSPP cylindric Male with O-Ring and retaining ring

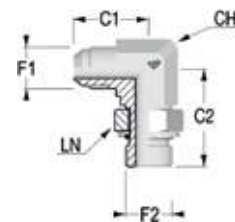

Item Code	Head 1 / Head 2	OD1 in	F1	F2	C1	C2	CH	LN
	Dash				mm	mm	mm	mm
1207238	-0402	1/4"	7/16-20	1/8-28	22,5	26,0	12,0	14,0
1207239	-0404	1/4"	7/16-20	1/4-19	27,0	31,5	14,0	19,0
1213024	-0406	1/4"	7/16-20	3/8-19	28,5	36,5	17,0	22,0
1213025	-0408	1/4"	7/16-20	1/2-14	31,0	43,0	22,0	27,0
1207240	-0502	5/16"	1/2-20	1/8-28	24,0	27,5	14,0	14,0
1207241	-0504	5/16"	1/2-20	1/4-19	27,0	31,5	14,0	19,0
1207743	-0506	5/16"	1/2-20	3/8-19	28,5	36,5	17,0	22,0
1207242	-0604	3/8"	9/16-18	1/4-19	27,0	31,5	14,0	19,0
1207243	-0606	3/8"	9/16-18	3/8-19	28,5	36,5	17,0	22,0
1208226	-0608	3/8"	9/16-18	1/2-14	31,0	43,0	22,0	27,0
1207244	-0804	1/2"	3/4-16	1/4-19	31,5	33,5	19,0	19,0
1207245	-0806	1/2"	3/4-16	3/8-19	31,5	36,5	19,0	22,0
1207246	-0808	1/2"	3/4-16	1/2-14	34,0	43,0	22,0	27,0
1213026	-0812	1/2"	3/4-16	3/4-14	37,0	49,0	27,0	36,0
1207744	-1006	5/8"	7/8-14	3/8-19	36,5	39,5	22,0	22,0
1207247	-1008	5/8"	7/8-14	1/2-14	36,5	43,0	22,0	27,0
1207745	-1012	5/8"	7/8-14	3/4-14	39,5	49,0	27,0	36,0
1207248	-1208	3/4"	1 1/16-12	1/2-14	42,0	45,5	27,0	27,0
1207249	-1212	3/4"	1 1/16-12	3/4-14	42,0	49,0	27,0	36,0
1207250	-1216	3/4"	1 1/16-12	1-11	44,5	52,0	33,0	41,0
1213027	-1412	7/8"	1 3/16-12	3/4-14	44,0	50,5	33,0	36,0
1207251	-1612	1"	1 5/16-12	3/4-14	46,0	52,0	33,0	36,0
1207252	-1616	1"	1 5/16-12	1-11	46,0	52,0	33,0	41,0
1207746	-1620	1"	1 5/16-12	1 1/4-11	51,0	57,0	41,0	50,0
1207253	-2016	1"1/4	1 5/8-12	1-11	52,0	57,0	41,0	41,0
1207254	-2020	1"1/4	1 5/8-12	1 1/4-11	52,0	57,0	41,0	50,0
1213028	-2420	1"1/2	1 7/8-12	1 1/4-11	59,0	61,0	48,0	50,0
1207255	-2424	1"1/2	1 7/8-12	1 1/2-11	59,0	61,0	48,0	55,0

Dimensions shown may be changed without prior notice

// R1A25M906Y

90° adjustable long elbow connector JIC Male - BSPP cylindric
Male with O-Ring and retaining ring

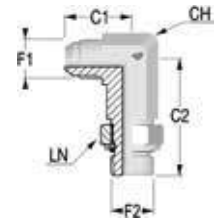

Item Code	Head 1 / Head 2	OD1 in	F1	F2	C1	C2	CH	LN
	Dash				mm	mm	mm	mm
1213029	-0402	1/4"	7/16-20	1/8-28	22,5	46,0	12,0	14,0
1213030	-0404	1/4"	7/16-20	1/4-19	27,0	56,5	14,0	19,0
1213031	-0406	1/4"	7/16-20	3/8-19	28,5	67,0	17,0	22,0
1213032	-0408	1/4"	7/16-20	1/2-14	31,0	78,0	22,0	27,0
1213033	-0502	5/16"	1/2-20	1/8-28	24,0	49,5	14,0	14,0
1213034	-0504	5/16"	1/2-20	1/4-19	27,0	56,5	14,0	19,0
1213035	-0506	5/16"	1/2-20	3/8-19	28,5	67,0	17,0	22,0
1213036	-0604	3/8"	9/16-18	1/4-19	27,0	56,5	14,0	19,0
1213037	-0606	3/8"	9/16-18	3/8-19	28,5	67,0	17,0	22,0
1213038	-0608	3/8"	9/16-18	1/2-14	31,0	78,0	22,0	27,0
1213039	-0804	1/2"	3/4-16	1/4-19	31,5	64,0	19,0	19,0
1213040	-0806	1/2"	3/4-16	3/8-19	31,5	67,0	19,0	22,0
1213041	-0808	1/2"	3/4-16	1/2-14	34,0	78,0	22,0	27,0
1213042	-0812	1/2"	3/4-16	3/4-14	37,0	92,0	27,0	36,0
1213043	-1006	5/8"	7/8-14	3/8-19	36,5	75,0	22,0	22,0
1213044	-1008	5/8"	7/8-14	1/2-14	36,5	78,0	22,0	27,0
1213045	-1012	5/8"	7/8-14	3/4-14	39,5	92,0	27,0	36,0
1213046	-1208	3/4"	1 1/16-12	1/2-14	42,0	88,0	27,0	27,0
1213047	-1216	3/4"	1 1/16-12	1-11	44,5	105,0	33,0	41,0
1216418	-1412	7/8"	1 3/16-12	3/4-14	44,0	99,0	33,0	36,0
1213048	-1616	1"	1 5/16-12	1-11	46,0	105,0	33,0	41,0
1213049	-1620	1"	1 5/16-12	1 1/4-11	51,0	123,0	41,0	50,0
1213050	-2016	1 1/4"	1 5/8-12	1-11	52,0	124,0	41,0	41,0
1213051	-2020	1 1/4"	1 5/8-12	1 1/4-11	52,0	123,0	41,0	50,0
1213052	-2420	1 1/2"	1 7/8-12	1 1/4-11	59,0	134,0	48,0	50,0
1213053	-2424	1 1/2"	1 7/8-12	1 1/2-11	59,0	135,0	48,0	55,0

// R1A25MT06N

**Branch Tee adjustable elbow connector JIC Male - BSPP
cylindric Male with O-Ring and retaining ring**

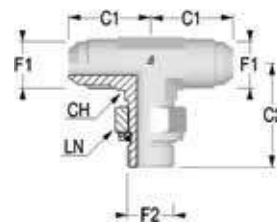

Item Code	Head 1 / Head 2	OD1 in	F1	F2	C1	C2	CH	LN
	Dash				mm	mm	mm	mm
1208134	-0402	1/4"	7/16-20	7/16-20	22,5	26,0	12,0	14,0
1210701	-0404	1/4"	7/16-20	7/16-20	27,0	31,5	14,0	19,0
1212762	-0406	1/4"	7/16-20	7/16-20	28,5	36,5	17,0	22,0
1212763	-0408	1/4"	7/16-20	7/16-20	31,0	43,0	22,0	27,0
1212764	-0502	5/16"	1/2-20	1/2-20	24,0	27,5	14,0	14,0
1207314	-0504	5/16"	1/2-20	1/2-20	27,0	31,5	14,0	19,0
1212765	-0506	5/16"	1/2-20	1/2-20	28,5	36,5	17,0	22,0
1207313	-0604	3/8"	9/16-18	9/16-18	27,0	31,5	14,0	19,0
1210744	-0606	3/8"	9/16-18	9/16-18	28,5	36,5	17,0	22,0
1212766	-0608	3/8"	9/16-18	9/16-18	31,0	43,0	22,0	27,0
1212767	-0804	1/2"	3/4-16	3/4-16	31,5	33,5	19,0	19,0
1240190	-0806	1/2"	3/4-16	3/4-16	31,5	36,5	19,0	22,0
1207316	-0808	1/2"	3/4-16	3/4-16	34,0	43,0	22,0	27,0
1212768	-0812	1/2"	3/4-16	3/4-16	37,0	49,0	27,0	36,0
1212769	-1006	5/8"	7/8-14	7/8-14	36,5	39,5	22,0	22,0
1207317	-1008	5/8"	7/8-14	7/8-14	36,5	43,0	22,0	27,0
1212770	-1012	5/8"	7/8-14	7/8-14	36,5	43,0	27,0	36,0
1207318	-1208	3/4"	1 1/16-12	1 1/16-12	42,0	45,5	27,0	27,0
1207319	-1212	3/4"	1 1/16-12	1 1/16-12	42,0	49,0	27,0	36,0
1212771	-1216	3/4"	1 1/16-12	1 1/16-12	44,5	52,0	33,0	41,0
1216449	-1412	7/8"	1 3/16-12	1 1/16-12	44,0	50,5	33,0	36,0
1212772	-1612	1"	1 5/16-12	1 5/16-12	46,0	52,0	33,0	36,0
1207320	-1616	1"	1 5/16-12	1 5/16-12	46,0	52,0	33,0	41,0
1212773	-1620	1"	1 5/16-12	1 5/16-12	51,0	57,0	41,0	50,0
1212774	-2016	1"1/4	1 5/8-12	1 5/8-12	52,0	57,0	41,0	41,0
1211631	-2020	1"1/4	1 5/8-12	1 5/8-12	52,0	57,0	41,0	50,0
1211632	-2420	1"1/2	1 7/8-12	1 7/8-12	59,0	61,0	48,0	50,0
1211633	-2424	1"1/2	1 7/8-12	1 7/8-12	59,0	61,0	48,0	55,0

Dimensions shown may be changed without prior notice

// R1A25ML06N

Run Tee adjustable elbow connector JIC Male - BSPP cylindric
Male with O-Ring and retaining ring

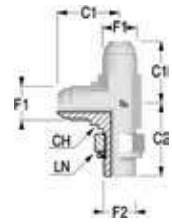

Item Code	Head 1 / Head 2	OD1	F1	F2	C1	C2	CH	LN
	Dash	in			mm	mm	mm	mm
1210740	-0402	1/4"	7/16-20	1/8-28	22,5	26,0	12,0	14,0
1210742	-0404	1/4"	7/16-20	1/4-19	27,0	31,5	14,0	19,0
1212702	-0406	1/4"	7/16-20	3/8-19	28,5	36,5	17,0	22,0
1212703	-0408	1/4"	7/16-20	1/2-14	31,0	43,0	22,0	27,0
1210694	-0504	5/16"	1/2-20	1/4-19	27,0	31,5	14,0	19,0
1212704	-0506	5/16"	1/2-20	3/8-19	28,5	36,5	17,0	22,0
1207292	-0604	3/8"	9/16-18	1/4-19	27,0	31,5	14,0	19,0
1207293	-0606	3/8"	9/16-18	3/8-19	28,5	36,5	17,0	22,0
1212705	-0608	3/8"	9/16-18	1/2-14	31,0	43,0	22,0	27,0
1212706	-0804	1/2"	3/4-16	1/4-19	31,5	33,5	19,0	19,0
1207294	-0806	1/2"	3/4-16	3/8-19	31,5	36,5	19,0	22,0
1207295	-0808	1/2"	3/4-16	1/2-14	34,0	43,0	22,0	27,0
1212707	-0812	1/2"	3/4-16	3/4-14	37,0	49,0	27,0	36,0
1212708	-1006	5/8"	7/8-14	3/8-19	36,5	39,5	22,0	22,0
1207748	-1008	5/8"	7/8-14	1/2-14	36,5	43,0	22,0	27,0
1208030	-1012	5/8"	7/8-14	3/4-14	39,5	49,0	27,0	36,0
1207299	-1208	3/4"	1 1/16-12	1/2-14	42,0	45,5	27,0	27,0
1207296	-1212	3/4"	1 1/16-12	3/4-14	42,0	49,0	27,0	36,0
1208124	-1216	3/4"	1 1/16-12	1-11	44,5	52,0	33,0	41,0
1208277	-1612	1"	1 5/16-12	3/4-14	46,0	52,0	33,0	36,0
1207297	-1616	1"	1 5/16-12	1-11	46,0	52,0	33,0	41,0
1212710	-1620	1"	1 5/16-12	1 1/4-11	51,0	57,0	41,0	50,0
1212711	-2016	1"1/4	1 5/8-12	1-11	52,0	57,0	41,0	41,0
1212712	-2420	1"1/2	1 7/8-12	1 1/4-11	59,0	61,0	48,0	50,0
1208125	-2424	1"1/2	1 7/8-12	1 1/2-11	59,0	61,0	48,0	55,0

// R1A25M107M

Straight connector JIC Male - BSPT Male

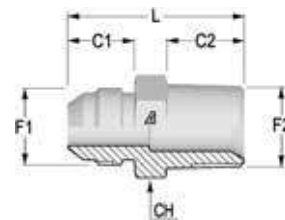

Item Code	Head 1 / Head 2	OD1 in	F1	F2	C1	C2	CH mm	L mm
	Dash				mm	mm		
1203683	-0402	1/4"	7/16-20	1/8-28	14,0	8,0	14,0	30,5
1203682	-0404	1/4"	7/16-20	1/4-19	14,0	12,0	14,0	35,5
1203626	-0502	5/16"	1/2-20	1/8-28	14,0	8,0	14,0	30,5
1203625	-0504	5/16"	1/2-20	1/4-19	14,0	12,0	14,0	35,5
1203711	-0604	3/8"	9/16-18	1/4-19	14,0	12,0	17,0	35,5
1203712	-0606	3/8"	9/16-18	3/8-19	14,0	12,0	19,0	35,5
1203710	-0608	3/8"	9/16-18	1/2-14	14,0	14,0	22,0	41,0
1203667	-0804	1/2"	3/4-16	1/4-19	17,0	12,0	19,0	38,5
1203669	-0806	1/2"	3/4-16	3/8-19	17,0	12,0	19,0	38,5
1203666	-0808	1/2"	3/4-16	1/2-14	17,0	14,0	22,0	43,5
1203696	-1006	5/8"	7/8-14	3/8-19	19,5	12,0	24,0	42,0
1203694	-1008	5/8"	7/8-14	1/2-14	19,5	14,0	24,0	46,5
1203695	-1012	5/8"	7/8-14	3/4-14	19,5	16,0	27,0	48,5
1203614	-1208	3/4"	1 1/16-12	1/2-14	22,0	14,0	27,0	51,0
1203615	-1212	3/4"	1 1/16-12	3/4-14	22,0	16,0	27,0	51,0
1203613	-1216	3/4"	1 1/16-12	1-11	22,0	18,0	36,0	56,5
1216391	-1412	7/8"	1 3/16-12	3/4-14	22,5	16,0	32,0	50,5
1203638	-1612	1"	1 5/16-12	3/4-14	23,0	16,0	36,0	53,0
1203636	-1616	1"	1 5/16-12	1-11	23,0	18,0	36,0	58,0
1203644	-2016	1 1/4"	1 5/8-12	1-11	24,5	18,0	46,0	60,5
1203645	-2020	1 1/4"	1 5/8-12	1 1/4-11	24,5	20,0	46,0	61,0
1203652	-2424	1 1/2"	1 7/8-12	1 1/2-11	27,5	20,0	50,0	68,0

Dimensions shown may be changed without prior notice

// R1A25M907M

90° elbow connector JIC Male - BSPT Male

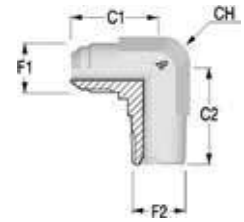

Item Code	Head 1 / Head 2	OD1 in	F1	F2	C1	C2	CH
	Dash				mm	mm	mm
1203874	-0402	1/4"	7/16-20	1/8-28	22,5	19,5	12,0
1203873	-0404	1/4"	7/16-20	1/4-19	27,0	27,5	14,0
1203840	-0502	5/16"	1/2-20	1/8-28	24,0	20,0	14,0
1203839	-0504	5/16"	1/2-20	1/4-19	27,0	27,0	14,0
1203895	-0604	3/8"	9/16-18	1/4-19	27,0	27,0	14,0
1203896	-0606	3/8"	9/16-18	3/8-19	28,5	31,0	17,0
1203894	-0608	3/8"	9/16-18	1/2-14	31,0	37,5	22,0
1203864	-0804	1/2"	3/4-16	1/4-19	31,5	31,0	19,0
1203865	-0806	1/2"	3/4-16	3/8-19	31,5	31,0	19,0
1203863	-0808	1/2"	3/4-16	1/2-14	34,0	37,0	22,0
1203883	-1006	5/8"	7/8-14	3/8-19	36,5	32,5	22,0
1203881	-1008	5/8"	7/8-14	1/2-14	36,5	40,0	22,0
1203882	-1012	5/8"	7/8-14	3/4-14	39,5	40,5	27,0
1203835	-1212	3/4"	1 1/16-12	3/4-14	42,0	40,5	27,0
1203833	-1216	3/4"	1 1/16-12	1-11	44,5	50,0	33,0
1216419	-1412	7/8"	1 3/16-12	3/4-14	44,0	43,0	33,0
1203847	-1612	1"	1 5/16-12	3/4-14	46,0	45,0	33,0
1203846	-1616	1"	1 5/16-12	1-11	46,0	50,0	33,0
1205460	-2016	1"1/4	1 5/8-12	1-11	52,0	59,5	41,0
1203853	-2020	1"1/4	1 5/8-12	1 1/4-11	52,0	60,5	41,0
1213054	-2424	1"1/2	1 7/8-12	1 1/2-11	59,0	67,0	48,0

// METRIC

// R1A2511525

Straight connector JIC Female - Metric Male with O-Ring

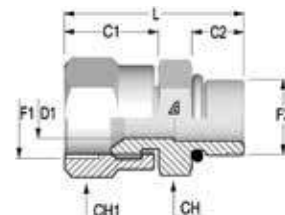

Item Code	Head 1 / Head 2	OD1	F1	F2	C1	C2	CH	CH1	L
	Dash/mm	in			mm	mm	mm	mm	mm
1207442	-0410	1/4"	7/16-20	M10X1.0	17,0	8,5	14,0	16,0	34,5
1216347	-0412	1/4"	7/16-20	M12X1.5	17,0	11,0	17,0	16,0	36,5
1216348	-0510	5/16"	1/2-20	M10X1.0	18,5	8,5	14,0	17,0	36,5
1207443	-0512	5/16"	1/2-20	M12X1.5	18,5	11,0	17,0	17,0	39,0
1216349	-0514	5/16"	1/2-20	M14X1.5	18,5	11,0	19,0	17,0	40,0
1207444	-0614	3/8"	9/16-18	M14X1.5	19,0	11,0	19,0	19,0	41,0
1216350	-0616	3/8"	9/16-18	M16X1.5	19,0	11,5	22,0	19,0	42,5
1216351	-0818	1/2"	3/4-16	M18X1.5	22,5	12,5	24,0	25,0	45,5
1207629	-1018	5/8"	7/8-14	M18X1.5	25,5	12,5	24,0	27,0	48,5
1216352	-1020	5/8"	7/8-14	M20X1.5	25,5	13,0	24,0	27,0	50,0
1207446	-1022	5/8"	7/8-14	M22X1.5	25,5	13,0	27,0	27,0	51,0
1216353	-1222	3/4"	1 1/16-12	M22X1.5	27,0	13,0	27,0	32,0	53,5
1207447	-1227	3/4"	1 1/16-12	M27X2	27,0	16,0	32,0	32,0	57,5
1216354	-1426	7/8"	1 3/16-12	M26X1.5	49,5	16,0	32,0	36,0	60,0
1216355	-1627	1"	1 5/16-12	M27X2	30,0	16,0	36,0	38,0	60,0
1207448	-1633	1"	1 5/16-12	M33X2.0	30,0	16,0	41,0	38,0	61,0

Dimensions shown may be changed without prior notice

// R1A25M1525

Straight connector JIC Male - Metric Male with O-Ring

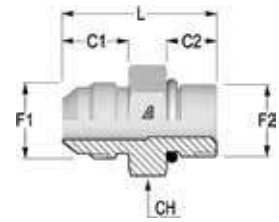

Item Code	Head 1 / Head 2	OD1 in	F1	F2	C1	C2	CH mm	L mm
	Dash				mm	mm		
1207635	-0412	1/4"	7/16-20	M12X1.5	14,0	13,5	17,0	31,5
1207636	-0510	5/16"	1/2-20	M10X1.0	14,0	11,0	14,0	30,5
1224083	-0512	5/16"	1/2-20	M12X1.5	14,0	13,5	17,0	33,5
1207408	-0614	3/8"	9/16-18	M14X1.5	14,0	13,5	19,0	33,5
1207639	-0616	3/8"	9/16-18	M16X1.5	14,0	14,0	22,0	35,0
1211696	-0816	1/2"	3/4-16	M16X1.5	16,5	14,0	22,0	35,0
1207387	-0818	1/2"	3/4-16	M18X1.5	16,5	15,0	24,0	37,0
1225818	-1018	5/8"	7/8-14	M18X1.5	19,5	15,0	24,0	38,5
1212958	-1020	5/8"	7/8-14	M20X1.5	19,5	15,5	24,0	41,5
1207405	-1022	5/8"	7/8-14	M22X1.5	22,0	15,5	27,0	43,0
1207404	-1222	3/4"	1 1/16-12	M22X1.5	22,0	18,5	27,0	45,5
1207403	-1227	3/4"	1 1/16-12	M27X2	23,0	18,5	32,0	49,0
1216402	-1627	1"	1 5/16-12	M27X2	24,5	18,5	36,0	50,5
1207402	-1633	1"	1 5/16-12	M33X2.0	27,5	20,0	41,0	51,0
1207401	-2042	1"1/4	1 5/8-12	M42X2	66,0	16,0	50,0	55,0
1207400	-2448	1"1/2	1 7/8-12	M48X2.0	76,0	17,5	55,0	60,0

// R1A25M152I

Straight connector JIC Male - Metric Male with elastomer

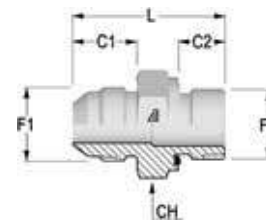

Item Code	Head 1 / Head 2	OD1	F1	F2	C1	C2	CH	L
	Dash	in			mm	mm		
1207390	-0410	1/4"	7/16-20	M10X1.0	14,0	8,0	14,0	31,0
1212950	-0412	1/4"	7/16-20	M12X1.5	14,0	12,0	17,0	33,5
1212951	-0510	5/16"	1/2-20	M10X1.0	14,0	8,0	14,0	30,5
1207391	-0512	5/16"	1/2-20	M12X1.5	14,0	12,0	17,0	33,5
1208306	-0514	5/16"	1/2-20	M14X1.5	14,0	12,0	19,0	35,0
1207392	-0614	3/8"	9/16-18	M14X1.5	14,0	12,0	19,0	33,5
1212952	-0616	3/8"	9/16-18	M16X1.5	14,0	12,0	22,0	35,5
1207393	-0816	1/2"	3/4-16	M16X1.5	16,5	12,0	22,0	37,5
1207388	-0818	1/2"	3/4-16	M18X1.5	16,5	12,0	24,0	39,0
1207389	-1018	5/8"	7/8-14	M18X1.5	19,5	12,0	24,0	41,5
1212953	-1020	5/8"	7/8-14	M20X1.5	19,5	14,0	24,0	43,5
1207394	-1022	5/8"	7/8-14	M22X1.5	19,5	14,0	27,0	43,0
1207395	-1222	3/4"	1 1/16-12	M22X1.5	22,0	14,0	27,0	45,5
1207396	-1227	3/4"	1 1/16-12	M27X2	22,0	16,0	32,0	49,0
1216405	-1426	7/8"	1 3/16-12	M26X1.5	22,5	16,0	32,0	49,5
1212957	-1627	1"	1 5/16-12	M27X2	23,0	16,0	36,0	55,0
1207397	-1633	1"	1 5/16-12	M33X2.0	23,0	18,0	41,0	51,5
1207398	-2042	1 1/4"	1 5/8-12	M42X2	24,5	20,0	50,0	55,0
1207399	-2448	1 1/2"	1 7/8-12	M48X2.0	27,5	22,0	55,0	60,5

// R1A25M152H

Long connector JIC Male - Metric Male with elastomer

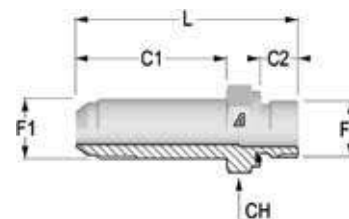

Item Code	Head 1 / Head 2	OD1	F1	F2	C1	C2	CH	L
	Dash	in			mm	mm		
1212934	-0410	1/4"	7/16-20	M10X1.0	35,0	9,5	14,0	51,0
1212935	-0510	5/16"	1/2-20	M10X1.0	37,0	9,5	14,0	53,0
1212936	-0512	5/16"	1/2-20	M12X1.5	37,0	14,0	17,0	55,5
1212937	-0514	5/16"	1/2-20	M14X1.5	37,0	14,0	19,0	56,5
1212938	-0614	3/8"	9/16-18	M14X1.5	39,0	14,0	19,0	58,5
1212939	-0616	3/8"	9/16-18	M16X1.5	39,0	14,0	22,0	60,0
1212940	-0816	1/2"	3/4-16	M16X1.5	48,0	14,0	22,0	69,0
1212941	-0818	1/2"	3/4-16	M18X1.5	48,0	14,5	24,0	70,5
1212942	-1018	5/8"	7/8-14	M18X1.5	53,0	14,5	24,0	75,5
1212943	-1022	5/8"	7/8-14	M22X1.5	53,0	17,0	27,0	78,0
1212944	-1222	3/4"	1 1/16-12	M22X1.5	63,0	17,0	27,0	89,0
1212945	-1227	3/4"	1 1/16-12	M27X2	63,0	19,0	32,0	92,5
1212946	-1627	1"	1 5/16-12	M27X2	72,0	19,0	36,0	102,0
1212947	-1633	1"	1 5/16-12	M33X2.0	72,0	21,0	41,0	102,5
1212948	-2042	1 1/4"	1 5/8-12	M42X2	88,0	23,0	50,0	121,0
1212949	-2448	1 1/2"	1 7/8-12	M48X2.0	88,0	25,0	55,0	136,0

Dimensions shown may be changed without prior notice

// R1A25M952Q

90° adjustable elbow connector JIC Male - Metric Male with
O-Ring and retaining ring

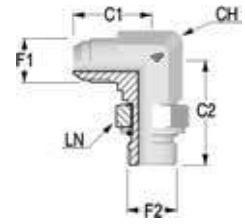

Item Code	Head 1 / Head 2	OD1	F1	F2	C1	C2	CH	LN
	Dash	in			mm	mm	mm	mm
1207275	-0410	1/4"	7/16-20	M10X1.0	22,5	27,5	12,0	14,0
1213138	-0412	1/4"	7/16-20	M12X1.5	27,0	31,5	14,0	17,0
1213140	-0510	5/16"	1/2-20	M10X1.0	24,0	27,5	14,0	14,0
1207276	-0512	5/16"	1/2-20	M12X1.5	27,0	31,5	14,0	17,0
1213141	-0514	5/16"	1/2-20	M14X1.5	27,0	32,5	14,0	19,0
1207277	-0614	3/8"	9/16-18	M14X1.5	27,0	32,5	14,0	19,0
1213142	-0616	3/8"	9/16-18	M16X1.5	28,5	36,5	17,0	22,0
1207278	-0816	1/2"	3/4-16	M16X1.5	31,5	36,5	19,0	22,0
1207523	-0818	1/2"	3/4-16	M18X1.5	31,5	39,5	19,0	24,0
1207279	-1018	5/8"	7/8-14	M18X1.5	36,5	41,5	22,0	24,0
1213144	-1020	5/8"	7/8-14	M20X1.5	36,5	43,0	22,0	27,0
1207280	-1022	5/8"	7/8-14	M22X1.5	36,5	43,0	22,0	27,0
1207281	-1222	3/4"	1 1/16-12	M22X1.5	42,0	45,5	27,0	27,0
1210693	-1227	3/4"	1 1/16-12	M27X2	42,0	51,5	27,0	32,0
1213145	-1426	7/8"	1 3/16-12	M26X1.5	44,0	50,5	27,0	36,0
1213146	-1627	1"	1 5/16-12	M27X2	46,0	55,0	33,0	32,0
1207282	-1633	1"	1 5/16-12	M33X1.5	46,0	55,0	33,0	41,0
1211742	-2042	1"1/4	1 5/8-12	M42X2	52,0	60,0	41,0	50,0
1213147	-2448	1"1/2	1 7/8-12	M48X1.5	59,0	67,0	48,0	55,0

// R1A25M952Y

90° adjustable long elbow connector JIC Male - Metric Male with O-Ring and retaining ring

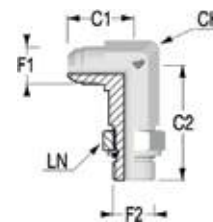

Item Code	Head 1 / Head 2	OD1	F1	F2	C1	C2	CH	LN
	Dash	in						
1213148	-0410	1/4"	7/16-20	M10X1.0	22,5	46,0	12,0	14,0
1213149	-0412	1/4"	7/16-20	M12X1.5	27,0	53,5	14,0	17,0
1213150	-0510	5/16"	1/2-20	M10X1.0	24,0	49,5	14,0	14,0
1213151	-0512	5/16"	1/2-20	M12X1.5	27,0	53,5	14,0	17,0
1213152	-0514	5/16"	1/2-20	M14X1.5	27,0	56,5	14,0	19,0
1213153	-0614	3/8"	9/16-18	M14X1.5	27,0	56,5	14,0	19,0
1213154	-0616	3/8"	9/16-18	M16X1.5	28,5	67,0	17,0	22,0
1213155	-0816	1/2"	3/4-16	M16X1.5	31,5	67,0	19,0	22,0
1213156	-0818	1/2"	3/4-16	M18X1.5	31,5	67,0	19,0	24,0
1213157	-1018	5/8"	7/8-14	M18X1.5	36,5	75,0	22,0	24,0
1213158	-1020	5/8"	7/8-14	M20X1.5	36,5	78,0	22,0	27,0
1213159	-1022	5/8"	7/8-14	M22X1.5	36,5	78,0	22,0	27,0
1213160	-1222	3/4"	1 1/16-12	M22X1.5	42,0	88,0	27,0	27,0
1213161	-1227	3/4"	1 1/16-12	M27X2	42,0	95,0	27,0	32,0
1216432	-1426	7/8"	1 3/16-12	M26X1.5	44,0	97,0	27,0	36,0
1213162	-1627	1"	1 5/16-12	M27X2	46,0	105,0	33,0	32,0
1213163	-1633	1"	1 5/16-12	M33X1.5	46,0	105,0	33,0	41,0
1213164	-2042	1"1/4	1 5/8-12	M42X2	52,0	124,0	41,0	50,0
1213165	-2448	1"1/2	1 7/8-12	M48X1.5	59,0	141,0	48,0	55,0

Dimensions shown may be changed without prior notice

// R1A25MT52Q

Branch Tee adjustable elbow connector JIC Male - Metric Male with O-Ring and retaining ring

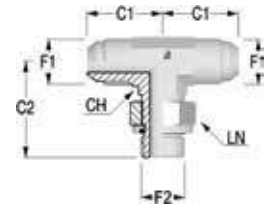

Item Code	Head 1 / Head 2	OD1	F1	F2	C1	C2	CH	LN
	Dash							
1211640	-0410	1/4"	7/16-20	7/16-20	22,5	27,5	12,0	14,0
1212815	-0412	1/4"	7/16-20	7/16-20	27,0	31,5	14,0	17,0
1212816	-0510	5/16"	1/2-20	1/2-20	24,0	27,5	14,0	14,0
1210706	-0512	5/16"	1/2-20	1/2-20	27,0	31,5	14,0	17,0
1212817	-0514	5/16"	1/2-20	1/2-20	27,0	32,5	14,0	19,0
1207324	-0614	3/8"	9/16-18	9/16-18	27,0	32,5	14,0	19,0
1212818	-0616	3/8"	9/16-18	9/16-18	28,5	36,5	17,0	22,0
1210707	-0816	1/2"	3/4-16	3/4-16	31,5	36,5	19,0	22,0
1212819	-0818	1/2"	3/4-16	3/4-16	31,5	39,5	19,0	24,0
1212820	-1020	5/8"	7/8-14	7/8-14	36,5	43,0	22,0	27,0
1211641	-1022	5/8"	7/8-14	7/8-14	36,5	43,0	22,0	27,0
1212821	-1222	3/4"	1 1/16-12	1 1/16-12	42,0	45,5	27,0	27,0
1211642	-1227	3/4"	1 1/16-12	1 1/16-12	42,0	51,5	27,0	32,0
1216493	-1426	7/8"	1 3/16-12	1 3/16-12	44,0	50,5	27,0	36,0
1212822	-1627	1"	1 5/16-12	1 5/16-12	46,0	55,0	33,0	32,0
1211643	-1633	1"	1 5/16-12	1 5/16-12	46,0	55,0	33,0	41,0
1211644	-2042	1 1/4"	1 5/8-12	1 5/8-12	52,0	60,0	41,0	50,0
1211645	-2448	1 1/2"	1 7/8-12	1 7/8-12	59,0	67,0	48,0	55,0

// R1A25ML52Q

Run Tee adjustable elbow connector JIC Male - Metric Male with O-Ring and retaining ring



Item Code	Head 1 / Head 2	OD1	F1	F2	C1	C2	CH	LN
	Dash							
1210699	-0410	1/4"	7/16-20	M10X1.0	22,5	27,5	12,0	14,0
1212753	-0412	1/4"	7/16-20	M12X1.5	27,0	31,5	14,0	17,0
1212754	-0510	5/16"	1/2-20	M10X1.0	24,0	27,5	14,0	14,0
1211626	-0512	5/16"	1/2-20	M12X1.5	27,0	31,5	14,0	17,0
1212755	-0514	5/16"	1/2-20	M14X1.5	27,0	32,5	14,0	19,0
1207303	-0614	3/8"	9/16-18	M14X1.5	27,0	32,5	14,0	19,0
1212756	-0616	3/8"	9/16-18	M16X1.5	28,5	36,5	17,0	22,0
1207302	-0816	1/2"	3/4-16	M16X1.5	31,5	36,5	19,0	22,0
1212757	-0818	1/2"	3/4-16	M18X1.5	31,5	39,5	19,0	24,0
1212758	-1018	5/8"	7/8-14	M18X1.5	36,5	41,5	22,0	24,0
1212759	-1020	5/8"	7/8-14	M20X1.5	36,5	43,0	22,0	27,0
1210700	-1022	5/8"	7/8-14	M22X1.5	36,5	43,0	22,0	27,0
1212760	-1222	3/4"	1 1/16-12	M22X1.5	42,0	45,5	27,0	27,0
1211627	-1227	3/4"	1 1/16-12	M27X2	42,0	51,5	27,0	32,0
1216448	-1426	7/8"	1 3/16-12	M26X1.5	44,0	50,5	27,0	36,0
1212761	-1627	1"	1 5/16-12	M27X2	46,0	55,0	33,0	32,0
1211628	-1633	1"	1 5/16-12	M33X1.5	46,0	55,0	33,0	41,0
1211629	-2042	1 1/4"	1 5/8-12	M42X2	52,0	60,0	41,0	50,0
1211630	-2448	1 1/2"	1 7/8-12	M48X1.5	59,0	67,0	48,0	55,0

// SAE UNF

// R1A25M1305

Straight connector JIC Male - SAE UNF/UN Male with O-Ring

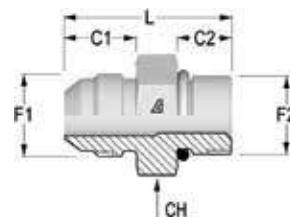

Item Code	Head 1 / Head 2	OD1 in	F1	F2	C1	C2	CH mm	L mm
	Dash				mm	mm		
1207370	-0404	1/4"	7/16-20	7/16-20	8,3	9,0	14,0	31,0
1207371	-0405	1/4"	7/16-20	1/2-20	8,3	9,0	16,0	31,0
1207630	-0406	1/4"	7/16-20	9/16-18	8,3	10,0	17,0	32,5
1207372	-0505	5/16"	1/2-20	1/2-20	9,0	9,0	17,0	31,0
1208278	-0604	3/8"	9/16-18	7/16-20	9,0	9,0	17,0	32,0
1216397	-0605	3/8"	9/16-18	1/2-20	9,0	9,0	17,0	32,5
1207373	-0606	3/8"	9/16-18	9/16-18	9,0	10,0	17,0	33,0
1207374	-0608	3/8"	9/16-18	3/4-16	9,0	11,0	22,0	35,0
1207375	-0808	1/2"	3/4-16	3/4-16	11,5	11,0	22,0	38,0
1207376	-0810	1/2"	3/4-16	7/8-14	11,5	12,5	27,0	40,5
1207631	-0812	1/2"	3/4-16	1 1/16-12	11,5	15,0	32,0	44,5
1207632	-1008	5/8"	7/8-14	3/4-16	12,5	11,0	27,0	41,5
1207377	-1010	5/8"	7/8-14	7/8-14	12,5	12,5	27,0	43,0
1207633	-1012	5/8"	7/8-14	1 1/16-12	12,5	15,0	32,0	47,0
1207378	-1208	3/4"	1 1/16-12	3/4-16	13,0	11,0	27,0	48,5
1207379	-1210	3/4"	1 1/16-12	7/8-14	13,0	12,5	27,0	47,5
1207380	-1212	3/4"	1 1/16-12	1 1/16-12	13,0	15,0	32,0	50,0
1207381	-1216	3/4"	1 1/16-12	1 5/16-12	13,0	15,0	38,0	50,5
1216398	-1414	7/8"	1 3/16-12	1 3/16-12	12,4	15,0	36,0	50,5
1207382	-1612	1"	1 5/16-12	1 1/16-12	14,5	15,0	36,0	50,5
1207383	-1616	1"	1 5/16-12	1 5/16-12	14,5	15,0	38,0	52,0
1207634	-1620	1"	1 5/16-12	1 5/8-12	14,5	15,0	46,0	54,0
1205938	-2016	1"1/4	1 5/8-12	1 5/16-12	16,1	15,0	46,0	55,5
1207384	-2020	1"1/4	1 5/8-12	1 5/8-12	16,1	15,0	46,0	55,0
1207385	-2424	1"1/2	1 7/8-12	1 7/8-12	18,4	15,0	55,0	60,5

Dimensions shown may be changed without prior notice

// R1A25M130J

Long connector JIC Male - SAE UNF/UN Male with O-Ring

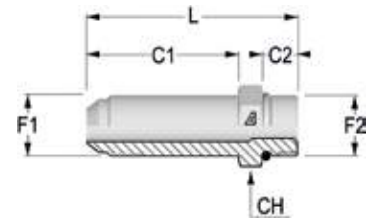

Item Code	Head 1 / Head 2	OD1	F1	F2	C1	C2	CH	L
	Dash	in						
1212883	-0404	1/4"	7/16-20	7/16-20	35,0	9,0	14,0	52,5
1212884	-0405	1/4"	7/16-20	1/2-20	35,0	9,0	14,0	52,5
1212885	-0406	1/4"	7/16-20	9/16-18	35,0	10,0	16,0	54,5
1212886	-0505	5/16"	1/2-20	1/2-20	37,0	9,0	17,0	54,5
1212888	-0606	3/8"	9/16-18	9/16-18	39,0	10,0	17,0	58,5
1212889	-0608	3/8"	9/16-18	3/4-16	39,0	11,0	22,0	60,0
1212890	-0808	1/2"	3/4-16	3/4-16	48,0	11,0	22,0	68,5
1212891	-0810	1/2"	3/4-16	7/8-14	48,0	12,5	27,0	71,5
1212892	-0812	1/2"	3/4-16	1 1/16-12	48,0	15,0	32,0	76,0
1212893	-1008	5/8"	7/8-14	3/4-16	53,0	11,0	22,0	75,5
1212894	-1010	5/8"	7/8-14	7/8-14	53,0	12,5	27,0	77,0
1212895	-1012	5/8"	7/8-14	1 1/16-12	53,0	15,0	27,0	81,5
1212898	-1212	3/4"	1 1/16-12	1 1/16-12	63,0	15,0	32,0	91,5
1212899	-1216	3/4"	1 1/16-12	1 5/16-12	63,0	15,0	41,0	92,5
1216400	-1414	7/8"	1 3/16-12	1 3/16-12	68,0	15,0	32,0	96,5
1212900	-1612	1"	1 5/16-12	1 1/16-12	72,0	15,0	32,0	100,0
1212901	-1616	1"	1 5/16-12	1 5/16-12	72,0	15,0	41,0	101,0
1212903	-2020	1"1/4	1 5/8-12	1 5/8-12	88,0	15,0	46,0	119,0
1212904	-2424	1"1/2	1 7/8-12	1 7/8-12	98,0	15,0	50,0	131,0

// R1A2511305

Straight connector JIC Female - SAE UNF/UN Male with O-Ring

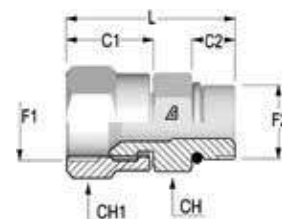

Item Code	Head 1 / Head 2	OD1	F1	F2	C1	C2	CH	CH1	L
	Dash/mm								
1207435	-0404	1/4"	7/16-20	7/16-20	8,3	9,0	14,0	16,0	34,0
1213175	-0405	1/4"	7/16-20	1/2-20	8,3	9,0	14,0	16,0	34,0
1213176	-0406	1/4"	7/16-20	9/16-18	8,3	10,0	16,0	16,0	35,0
1207436	-0505	5/16"	1/2-20	1/2-20	9,0	9,0	17,0	17,0	35,5
1207437	-0606	3/8"	9/16-18	9/16-18	9,0	10,0	17,0	19,0	37,0
1213177	-0608	3/8"	9/16-18	3/4-16	9,0	11,0	22,0	19,0	40,0
1207438	-0808	1/2"	3/4-16	3/4-16	11,5	11,0	22,0	25,0	43,5
1213178	-0810	1/2"	3/4-16	7/8-14	11,5	12,5	27,0	25,0	46,5
1213179	-0812	1/2"	3/4-16	1 1/16-12	11,5	15,0	32,0	25,0	49,5
1213180	-1008	5/8"	7/8-14	3/4-16	12,5	11,0	22,0	27,0	46,5
1207439	-1010	5/8"	7/8-14	7/8-14	12,5	12,5	27,0	27,0	49,5
1213181	-1012	5/8"	7/8-14	1 1/16-12	12,5	15,0	27,0	27,0	52,5
1213183	-1210	3/4"	1 1/16-12	7/8-14	13,0	12,5	27,0	32,0	51,0
1207440	-1212	3/4"	1 1/16-12	1 1/16-12	13,0	15,0	32,0	32,0	54,0
1213184	-1216	3/4"	1 1/16-12	1 5/16-12	13,0	15,0	41,0	32,0	54,0
1216346	-1414	7/8"	1 3/16-12	1 3/16-12	12,4	15,0	32,0	36,0	54,1
1213185	-1612	1"	1 5/16-12	1 1/16-12	14,5	15,0	32,0	38,0	57,0
1207441	-1616	1"	1 5/16-12	1 5/16-12	14,5	15,0	41,0	38,0	57,0
1213208	-2424	1 1/2"	1 7/8-12	1 7/8-12	18,4	15,0	50,0	55,0	67,0

Dimensions shown may be changed without prior notice

// R1A25M4305

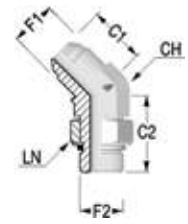
45° adjustable elbow connector JIC Male - SAE UNF/UN Male with O-Ring

Item Code	Head 1 / Head 2	OD1	F1	F2	C1	C2	CH	LN
	Dash	in						
1212979	-0405	1/4"	7/16-20	1/2-20	21,0	26,5	14,0	17,0
1207335	-0505	5/16"	1/2-20	1/2-20	21,0	26,5	14,0	17,0
1207336	-0606	3/8"	9/16-18	9/16-18	19,5	26,5	14,0	19,0
1212980	-0608	3/8"	9/16-18	3/4-16	22,5	38,0	19,0	24,0
1207337	-0808	1/2"	3/4-16	3/4-16	25,0	33,0	19,0	24,0
1212981	-0810	1/2"	3/4-16	7/8-14	27,5	42,5	22,0	27,0
1212982	-1008	5/8"	7/8-14	3/4-16	28,0	37,0	22,0	24,0
1207338	-1010	5/8"	7/8-14	7/8-14	28,0	38,5	22,0	27,0
1216413	-1012	5/8"	7/8-14	1 1/16-12	28,5	44,0	27,0	32,0
1212983	-1208	3/4"	1 1/16-12	3/4-16	32,5	37,5	27,0	24,0
1211710	-1210	3/4"	1 1/16-12	7/8-14	32,5	40,5	27,0	27,0
1207339	-1212	3/4"	1 1/16-12	1 1/16-12	32,5	44,0	27,0	32,0
1212984	-1216	3/4"	1 1/16-12	1 5/16-12	32,5	47,0	33,0	41,0
1212985	-1414	7/8"	1 3/16-12	1 3/16-12	37,0	47,0	33,0	38,0
1212986	-1612	1"	1 5/16-12	1 1/16-12	37,5	44,0	33,0	32,0
1207340	-1616	1"	1 5/16-12	1 5/16-12	37,5	47,0	33,0	41,0
1212987	-1620	1"	1 5/16-12	1 5/8-12	40,0	48,5	41,0	50,0
1211711	-2020	1"1/4	1 5/8-12	1 5/8-12	40,5	48,5	41,0	50,0
1211712	-2424	1"1/2	1 7/8-12	1 7/8-12	45,0	48,5	48,0	55,0

// R1A25M9305

90° adjustable elbow connector JIC Male - SAE UNF/UN Male with O-Ring

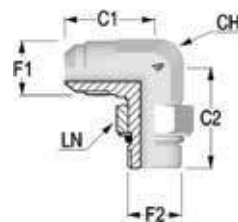

Item Code	Head 1 / Head 2	OD1	F1	F2	C1	C2	CH	LN
	Dash	in			mm	mm	mm	mm
1207256	-0404	1/4"	7/16-20	7/16-20	22,5	26,0	12,0	16,0
1207640	-0405	1/4"	7/16-20	1/2-20	24,0	27,5	14,0	17,0
1213077	-0406	1/4"	7/16-20	9/16-18	27,0	31,5	14,0	19,0
1207257	-0505	5/16"	1/2-20	1/2-20	24,0	27,5	14,0	17,0
1207258	-0606	3/8"	9/16-18	9/16-18	27,0	31,5	14,0	19,0
1207641	-0608	3/8"	9/16-18	3/4-16	28,5	36,5	19,0	24,0
1216429	-0610	3/8"	9/16-18	7/8-14	31,0	43,5	22,0	27,0
1207259	-0808	1/2"	3/4-16	3/4-16	31,5	36,5	19,0	24,0
1207642	-0810	1/2"	3/4-16	7/8-14	34,0	43,0	22,0	27,0
1213079	-0812	1/2"	3/4-16	1 1/16-12	37,0	49,0	27,0	32,0
1207643	-1008	5/8"	7/8-14	3/4-16	36,5	39,5	22,0	24,0
1207260	-1010	5/8"	7/8-14	7/8-14	36,5	43,0	22,0	27,0
1213080	-1012	5/8"	7/8-14	1 1/16-12	39,5	49,0	27,0	32,0
1213081	-1208	3/4"	1 1/16-12	3/4-16	42,0	42,0	27,0	24,0
1207261	-1210	3/4"	1 1/16-12	7/8-14	42,0	45,5	27,0	27,0
1207262	-1212	3/4"	1 1/16-12	1 1/16-12	42,0	49,0	27,0	32,0
1213082	-1216	3/4"	1 1/16-12	1 5/16-12	44,5	52,0	33,0	41,0
1213083	-1414	7/8"	1 3/16-12	1 3/16-12	44,0	50,5	33,0	38,0
1207263	-1612	1"	1 5/16-12	1 1/16-12	46,0	52,0	33,0	32,0
1207264	-1616	1"	1 5/16-12	1 5/16-12	46,0	54,6	33,0	41,0
1213084	-1620	1"	1 5/16-12	1 5/8-12	51,0	57,0	41,0	50,0
1207265	-2020	1"1/4	1 5/8-12	1 5/8-12	52,0	57,0	41,0	50,0
1211738	-2424	1"1/2	1 7/8-12	1 7/8-12	59,0	61,0	48,0	55,0

Dimensions shown may be changed without prior notice

// R1A25M930J

90° adjustable long elbow connector JIC Male - SAE UNF/UN
Male with O-Ring

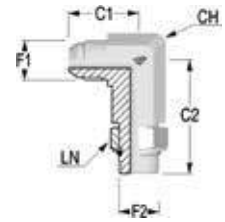

Item Code	Head 1 / Head 2	OD1	F1	F2	C1	C2	CH	LN
	Dash	in			mm	mm	mm	mm
1213056	-0404	1/4"	7/16-20	7/16-20	22,5	46,0	12,0	16,0
1213057	-0405	1/4"	7/16-20	1/2-20	24,0	49,5	14,0	17,0
1213058	-0406	1/4"	7/16-20	9/16-18	27,0	56,5	14,0	19,0
1213059	-0505	5/16"	1/2-20	1/2-20	24,0	49,5	14,0	17,0
1213060	-0606	3/8"	9/16-18	9/16-18	27,0	56,5	14,0	19,0
1213061	-0608	3/8"	9/16-18	3/4-16	28,5	67,0	19,0	24,0
1213062	-0808	1/2"	3/4-16	3/4-16	31,5	67,0	19,0	24,0
1213063	-0810	1/2"	3/4-16	7/8-14	34,0	78,0	22,0	27,0
1213064	-0812	1/2"	3/4-16	1 1/16-12	37,0	92,0	27,0	32,0
1213065	-1008	5/8"	7/8-14	3/4-16	36,5	75,0	22,0	24,0
1213066	-1010	5/8"	7/8-14	7/8-14	36,5	78,0	22,0	27,0
1213067	-1012	5/8"	7/8-14	1 1/16-12	39,5	92,0	27,0	32,0
1213068	-1208	3/4"	1 1/16-12	3/4-16	42,0	85,0	27,0	24,0
1213069	-1210	3/4"	1 1/16-12	7/8-14	42,0	88,0	27,0	27,0
1213070	-1212	3/4"	1 1/16-12	1 1/16-12	42,0	92,0	27,0	32,0
1213071	-1216	3/4"	1 1/16-12	1 5/16-12	44,5	105,0	33,0	41,0
1216431	-1414	7/8"	1 3/16-12	1 3/16-12	44,0	92,0	33,0	38,0
1213072	-1612	1"	1 5/16-12	1 1/16-12	46,0	105,0	33,0	32,0
1213073	-1616	1"	1 5/16-12	1 5/16-12	46,0	105,0	33,0	41,0
1213074	-1620	1"	1 5/16-12	1 5/8-12	51,0	124,0	41,0	50,0
1213075	-2020	1 1/4"	1 5/8-12	1 5/8-12	52,0	124,0	41,0	50,0
1213076	-2424	1 1/2"	1 7/8-12	1 7/8-12	59,0	135,0	48,0	55,0

// R1A25MT305

**Branch Tee adjustable elbow connector JIC Male - SAE UNF/UN
Male with O-Ring**

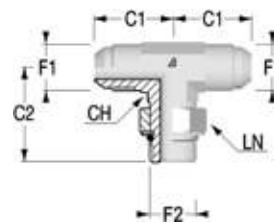

Item Code	Head 1 / Head 2	OD1 in	F1	F2	C1	C2	CH mm	LN mm
	Dash				mm	mm		
1210702	-0404	1/4"	7/16-20	7/16-20	22,5	26,0	12,0	16,0
1212777	-0405	1/4"	7/16-20	7/16-20	24,0	27,5	14,0	17,0
1212778	-0406	1/4"	7/16-20	7/16-20	27,0	31,5	14,0	19,0
1210703	-0505	5/16"	1/2-20	1/2-20	24,0	27,5	14,0	17,0
1207321	-0606	3/8"	9/16-18	9/16-18	27,0	31,5	14,0	19,0
1212779	-0608	3/8"	9/16-18	9/16-18	28,5	36,5	19,0	24,0
1207322	-0808	1/2"	3/4-16	3/4-16	31,5	36,5	19,0	24,0
1212780	-0810	1/2"	3/4-16	3/4-16	34,0	43,0	22,0	27,0
1212781	-0812	1/2"	3/4-16	3/4-16	37,0	49,0	27,0	32,0
1212782	-1008	5/8"	7/8-14	7/8-14	36,5	39,5	22,0	24,0
1207323	-1010	5/8"	7/8-14	7/8-14	36,5	43,0	22,0	27,0
1212783	-1012	5/8"	7/8-14	7/8-14	39,5	49,0	27,0	32,0
1212784	-1208	3/4"	1 1/16-12	1 1/16-12	42,0	42,0	27,0	24,0
1212785	-1210	3/4"	1 1/16-12	1 1/16-12	42,0	45,5	27,0	27,0
1210704	-1212	3/4"	1 1/16-12	1 1/16-12	42,0	49,0	27,0	32,0
1212786	-1216	3/4"	1 1/16-12	1 1/16-12	44,5	52,0	33,0	41,0
1216491	-1414	7/8"	1 3/16-12	1 3/16-12	44,0	50,5	33,0	38,0
1212787	-1612	1"	1 5/16-12	1 5/16-12	46,0	52,0	33,0	32,0
1210705	-1616	1"	1 5/16-12	1 5/16-12	46,0	54,6	33,0	41,0
1212788	-1620	1"	1 5/16-12	1 5/16-12	51,0	57,0	41,0	50,0
1212789	-2020	1"1/4	1 5/8-12	1 5/8-12	52,0	57,0	41,0	50,0
1212790	-2424	1"1/2	1 7/8-12	1 7/8-12	59,0	61,0	48,0	55,0

Dimensions shown may be changed without prior notice

// R1A25ML305

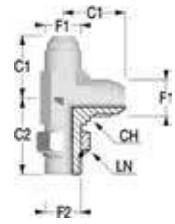
**Run Tee adjustable elbow connector JIC Male - SAE UNF/UNF
Male with O-Ring**

Item Code	Head 1 / Head 2	OD1	F1	F2	C1	C2	CH	LN
	Dash	in			mm	mm		
1210695	-0404	1/4"	7/16-20	7/16-20	22,5	26,0	12,0	16,0
1212716	-0405	1/4"	7/16-20	1/2-20	24,0	27,5	14,0	17,0
1212717	-0406	1/4"	7/16-20	9/16-18	27,0	31,5	14,0	19,0
1210696	-0505	5/16"	1/2-20	1/2-20	24,0	27,5	14,0	17,0
1207300	-0606	3/8"	9/16-18	9/16-18	27,0	31,5	14,0	19,0
1212718	-0608	3/8"	9/16-18	3/4-16	28,5	36,5	19,0	24,0
1210697	-0808	1/2"	3/4-16	3/4-16	31,5	36,5	19,0	24,0
1212719	-0810	1/2"	3/4-16	7/8-14	34,0	43,0	22,0	27,0
1212720	-0812	1/2"	3/4-16	1 1/16-12	37,0	49,0	27,0	32,0
1212721	-1008	5/8"	7/8-14	3/4-16	36,5	39,5	22,0	24,0
1210698	-1010	5/8"	7/8-14	7/8-14	36,5	43,0	22,0	27,0
1212722	-1012	5/8"	7/8-14	1 1/16-12	39,5	49,0	27,0	32,0
1212723	-1208	3/4"	1 1/16-12	3/4-16	42,0	42,0	27,0	24,0
1212724	-1210	3/4"	1 1/16-12	7/8-14	42,0	45,5	27,0	27,0
1207301	-1212	3/4"	1 1/16-12	1 1/16-12	42,0	49,0	27,0	32,0
1212725	-1216	3/4"	1 1/16-12	1 5/16-12	44,5	52,0	33,0	41,0
1211624	-1616	1"	1 5/16-12	1 5/16-12	46,0	54,6	33,0	41,0
1212727	-1620	1"	1 5/16-12	1 5/8-12	51,0	57,0	41,0	50,0
1211625	-2020	1"1/4	1 5/8-12	1 5/8-12	52,0	57,0	41,0	50,0
1212728	-2424	1"1/2	1 7/8-12	1 7/8-12	59,0	61,0	48,0	55,0

// NPTF

// R1A25M128M

Straight connector JIC - NPTF Male

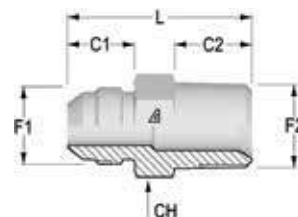

Item Code	Head 1 / Head 2	OD1 in	F1	F2	C1 mm	C2 mm	CH mm	L mm
	Dash							
1203679	-0402	1/4"	7/16-20	1/8-27	14,0	10,0	14,0	31,0
1203678	-0404	1/4"	7/16-20	1/4-18	14,0	14,5	14,0	36,0
1203621	-0502	5/16"	1/2-20	1/8-27	14,0	10,0	14,0	31,0
1203620	-0504	5/16"	1/2-20	1/4-18	14,0	14,5	14,0	36,0
1203704	-0602	3/8"	9/16-18	1/8-27	14,0	10,0	17,0	32,0
1203703	-0604	3/8"	9/16-18	1/4-18	14,0	14,5	17,0	36,5
1203705	-0606	3/8"	9/16-18	3/8-18	14,0	14,5	19,0	36,5
1203702	-0608	3/8"	9/16-18	1/2-14	14,0	19,0	22,0	43,0
1203659	-0804	1/2"	3/4-16	1/4-18	17,0	14,5	19,0	39,0
1203661	-0806	1/2"	3/4-16	3/8-18	17,0	14,5	19,0	39,0
1203658	-0808	1/2"	3/4-16	1/2-14	17,0	19,0	22,0	44,5
1203660	-0812	1/2"	3/4-16	3/4-14	17,0	19,0	27,0	47,0
1212881	-1004	5/8"	7/8-14	1/4-18	19,5	14,5	24,0	43,0
1203691	-1006	5/8"	7/8-14	3/8-18	19,5	14,5	24,0	43,5
1203689	-1008	5/8"	7/8-14	1/2-14	19,5	19,0	24,0	47,0
1203690	-1012	5/8"	7/8-14	3/4-14	19,5	19,0	27,0	49,5
1203608	-1208	3/4"	1 1/16-12	1/2-14	22,0	19,0	27,0	51,5
1203609	-1212	3/4"	1 1/16-12	3/4-14	22,0	19,0	27,0	52,5
1203607	-1216	3/4"	1 1/16-12	1-11 1/2	22,0	24,0	36,0	57,0
1216396	-1412	7/8"	1 3/16-12	3/4-14	22,5	19,0	30,0	53,0
1203633	-1612	1"	1 5/16-12	3/4-14	23,0	19,0	36,0	53,5
1203631	-1616	1"	1 5/16-12	1-11 1/2	23,0	24,0	36,0	58,5
1203642	-2016	1 1/4"	1 5/8-12	1-11 1/2	24,5	24,0	46,0	61,5
1203643	-2020	1 1/4"	1 5/8-12	1 1/4-11 1/2	24,5	24,5	46,0	62,5
1212882	-2420	1 1/2"	1 7/8-12	1 1/4-11 1/2	27,5	24,5	50,0	67,5
1203649	-2424	1 1/2"	1 7/8-12	1 1/2-11 1/2	27,5	25,5	50,0	68,0

Dimensions shown may be changed without prior notice

// R1A251128M

Straight connector JIC Female - NPTF Male

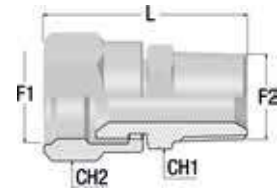

Item Code	Head 1 / Head 2	OD1	F1	F2	CH1	CH2	L
	Dash	in					
1210848	-0402	1/4"	7/16-20	1/8-27	16,0	14,0	34,2
1207618	-0404	1/4"	7/16-20	1/4-18	16,0	14,0	39,2
1213170	-0502	5/16"	1/2-20	1/8-27	17,0	14,0	35,5
1207619	-0504	5/16"	1/2-20	1/4-18	17,0	17,0	41,0
1213171	-0602	3/8"	9/16-18	1/8-27	19,0	19,0	37,0
1207620	-0604	3/8"	9/16-18	1/4-18	19,0	17,0	41,0
1207621	-0606	3/8"	9/16-18	3/8-18	19,0	19,0	41,5
1213173	-0804	1/2"	3/4-16	1/4-18	25,0	19,0	44,0
1207622	-0806	1/2"	3/4-16	3/8-18	25,0	19,0	43,2
1207624	-1008	5/8"	7/8-14	1/2-14	27,0	24,0	50,2
1213174	-1012	5/8"	7/8-14	3/4-14	27,0	30,0	52,5
1207625	-1208	3/4"	1 1/16-12	1/2-14	32,0	27,0	54,3
1207626	-1212	3/4"	1 1/16-12	3/4-14	32,0	30,0	55,3
1216345	-1412	7/8"	1 3/16-12	3/4-14	36,0	30,0	55,2
1207627	-1612	1"	1 5/16-12	3/4-14	38,0	32,0	58,6
1207628	-1616	1"	1 5/16-12	1-11 1/2	38,0	36,0	64,0
1213206	-2020	1 1/4"	1 5/8-12	1 1/4-11 1/2	50,0	46,0	69,4

// R1A25M428M

45° elbow connector JIC - NPTF Male



Item Code	Head 1 / Head 2	OD1	F1	F2	C1	C2	CH
	Dash	in					
1203920	-0402	1/4"	7/16-20	1/8-27	18,0	16,0	12,0
1203919	-0404	1/4"	7/16-20	1/4-18	21,0	21,5	14,0
1210674	-0504	5/16"	1/2-20	1/4-18	21,0	21,5	14,0
1203925	-0604	3/8"	9/16-18	1/4-18	21,0	21,5	14,0
1203927	-0606	3/8"	9/16-18	3/8-18	22,0	24,0	19,0
1203916	-0806	1/2"	3/4-16	3/8-18	25,0	24,0	19,0
1203915	-0808	1/2"	3/4-16	1/2-14	25,5	29,5	22,0
1212975	-1006	5/8"	7/8-14	3/8-18	28,0	24,5	22,0
1203923	-1008	5/8"	7/8-14	1/2-14	28,0	29,5	22,0
1212976	-1012	5/8"	7/8-14	3/4-14	30,0	30,5	27,0
1203907	-1208	3/4"	1 1/16-12	1/2-14	32,5	30,5	27,0
1203908	-1212	3/4"	1 1/16-12	3/4-14	32,5	30,5	27,0
1203913	-1616	1"	1 5/16-12	1-11 1/2	37,0	37,5	33,0

// R1A25M928M

90° elbow connector JIC - NPTF Male

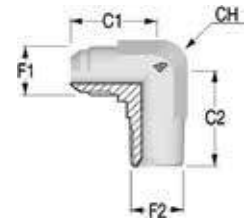

Item Code	Head 1 / Head 2	OD1	F1	F2	C1	C2	CH
	Dash	in			mm	mm	mm
1203872	-0402	1/4"	7/16-20	1/8-27	22,5	19,5	12,0
1203871	-0404	1/4"	7/16-20	1/4-18	27,0	27,5	14,0
1203838	-0502	5/16"	1/2-20	1/8-27	24,0	19,5	14,0
1203837	-0504	5/16"	1/2-20	1/4-18	27,0	27,5	14,0
1203889	-0604	3/8"	9/16-18	1/4-18	27,0	27,5	14,0
1203891	-0606	3/8"	9/16-18	3/8-18	28,5	31,0	19,0
1203888	-0608	3/8"	9/16-18	1/2-14	31,0	37,0	22,0
1203861	-0806	1/2"	3/4-16	3/8-18	31,5	31,0	19,0
1203858	-0808	1/2"	3/4-16	1/2-14	34,0	37,0	22,0
1203860	-0812	1/2"	3/4-16	3/4-14	37,0	40,5	27,0
1203878	-1008	5/8"	7/8-14	1/2-14	36,5	37,0	22,0
1203879	-1012	5/8"	7/8-14	3/4-14	39,5	40,5	27,0
1203831	-1208	3/4"	1 1/16-12	1/2-14	42,0	40,5	27,0
1203832	-1212	3/4"	1 1/16-12	3/4-14	42,0	40,5	27,0
1203843	-1616	1"	1 5/16-12	1-11 1/2	46,0	50,0	33,0
1203851	-2016	1"1/4	1 5/8-12	1-11 1/2	52,0	59,0	41,0
1203852	-2020	1"1/4	1 5/8-12	1 1/4-11 1/2	52,0	60,0	41,0

Dimensions shown may be changed without prior notice

// FLANGES

// R1A25M133W

Straight flange SAE J518 code 61 - JIC - Low pressure

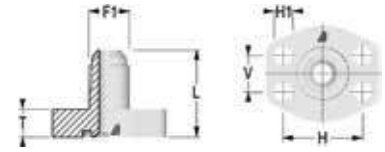

Item Code	Head / Flange	OD1	F1	Flange Size	L	T	H	V	H1
	Dash								
1212906	-0808	1/2"	3/4-16	1/2	41,0	14,0	38,1	17,5	9,0
1212907	-1008	5/8"	7/8-14	1/2	44,0	14,0	38,1	17,5	9,0
1212908	-1012	5/8"	7/8-14	3/4	47,0	15,0	47,6	22,2	11,0
1212909	-1208	3/4"	1 1/16-12	1/2	46,0	14,0	38,1	17,5	9,0
1212910	-1212	3/4"	1 1/16-12	3/4	49,0	15,0	47,6	22,2	11,0
1212911	-1216	3/4"	1 1/16-12	1	51,0	17,0	52,4	26,2	11,0
1212912	-1612	1"	1 5/16-12	3/4	50,0	15,0	47,6	22,2	11,0
1212913	-1616	1"	1 5/16-12	1	52,0	17,0	52,4	26,2	11,0
1212914	-1620	1"	1 5/16-12	3/4	56,0	21,0	58,7	30,2	11,5
1212915	-2016	1"1/4	1 5/8-12	1	54,0	17,0	52,4	26,2	11,0
1212916	-2020	1"1/4	1 5/8-12	1 1/4	58,0	21,0	58,4	30,2	11,5
1212917	-2024	1"1/4	1 5/8-12	1	64,0	24,0	69,9	35,7	13,5
1212918	-2420	1"1/2	1 7/8-12	1 1/4	61,0	21,0	58,4	30,2	11,5
1212919	-2424	1"1/2	1 7/8-12	1 1/2	67,0	24,0	69,9	35,7	13,5

// R1A25M136W

Straight flange SAE J518 code 62 - JIC - High pressure

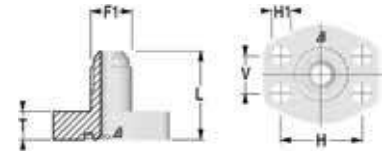

Item Code	Head / Flange	OD1	F1	Flange Size	L	T	H	V	H1
	Dash								
1212920	-0808	1/2"	3/4-16	1/2	42,0	15,0	40,5	18,2	9,0
1212921	-1008	5/8"	7/8-14	1/2	45,0	15,0	40,5	18,2	9,0
1212922	-1012	5/8"	7/8-14	3/4	49,0	17,0	50,8	23,8	11,0
1212923	-1208	3/4"	1 1/16-12	1/2	47,0	15,0	40,5	18,2	9,0
1212924	-1212	3/4"	1 1/16-12	3/4	51,0	17,0	50,8	23,8	11,0
1212925	-1216	3/4"	1 1/16-12	1	58,0	21,0	57,2	27,8	13,0
1212926	-1612	1"	1 5/16-12	3/4	52,0	17,0	50,8	23,8	11,0
1212927	-1616	1"	1 5/16-12	1	59,0	21,0	57,2	27,8	13,0
1212928	-1620	1"	1 5/16-12	1 1/4	64,0	24,0	66,7	31,8	15,0
1212929	-2016	1"1/4	1 5/8-12	1	61,0	21,0	57,2	27,8	13,0
1212930	-2020	1"1/4	1 5/8-12	1 1/4	66,0	24,0	66,7	31,8	15,0
1212931	-2024	1"1/4	1 5/8-12	1 1/2	70,0	27,0	79,4	36,5	17,0
1212932	-2420	1"1/2	1 7/8-12	1 1/4	69,0	24,0	66,7	31,8	15,0
1212933	-2424	1"1/2	1 7/8-12	1 1/2	73,0	27,0	79,4	36,5	17,0

// R1A25M933W

90° flange SAE J518 code 61 - JIC - Low pressure

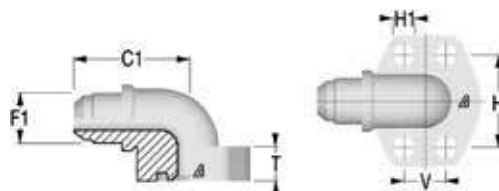

Item Code	Head / Flange	OD1	F1	Flange size	C1	T	H	V	H1
	Dash								
1213085	-0808	1/2"	3/4-16	1/2	40,0	17,0	38,1	17,5	9,0
1213086	-1008	5/8"	7/8-14	1/2	42,0	17,0	38,1	17,5	9,0
1213087	-1012	5/8"	7/8-14	3/4	45,0	20,0	47,6	22,2	11,0
1213088	-1208	3/4"	1 1/16-12	1/2	42,0	20,0	38,1	17,5	9,0
1213089	-1212	3/4"	1 1/16-12	3/4	47,0	20,0	47,6	22,2	11,0
1213090	-1216	3/4"	1 1/16-12	1	50,0	20,0	52,4	26,2	11,0
1213091	-1612	1"	1 5/16-12	3/4	48,0	25,0	47,6	22,2	11,0
1213092	-1616	1"	1 5/16-12	1	51,0	25,0	52,4	26,2	11,0
1213093	-1620	1"	1 5/16-12	1 1/4	56,0	25,0	58,7	30,2	11,5
1213094	-2016	1"1/4	1 5/8-12	1	53,0	31,0	52,4	26,2	11,0
1213095	-2020	1"1/4	1 5/8-12	1 1/4	58,0	31,0	58,4	30,2	11,5
1213096	-2024	1"1/4	1 5/8-12	1 1/2	63,0	31,0	69,9	35,7	13,5
1213097	-2420	1"1/2	1 7/8-12	1 1/4	58,0	37,0	58,4	30,2	11,5
1213098	-2424	1"1/2	1 7/8-12	1 1/2	66,0	37,0	69,9	35,7	13,5

// R1A25M936W

90° flange SAE J518 code 62 - JIC - High pressure

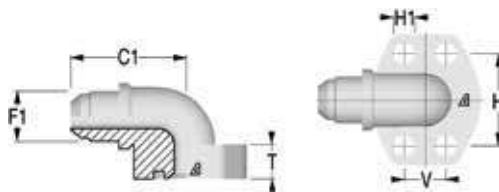

Item Code	Head / Flange	OD1	F1	Flange size	C1	T	H	V	H1
	Dash								
1213111	-0808	1/2"	3/4-16	1/2	40,0	17,0	40,5	18,2	9,0
1213112	-1008	5/8"	7/8-14	1/2	42,0	17,0	40,5	18,2	9,0
1213113	-1012	5/8"	7/8-14	3/4	49,0	20,0	50,8	23,8	11,0
1213114	-1208	3/4"	1 1/16-12	1/2	42,0	20,0	40,5	18,2	9,0
1213115	-1212	3/4"	1 1/16-12	3/4	51,0	20,0	50,8	23,8	11,0
1213116	-1216	3/4"	1 1/16-12	1	55,0	25,0	57,2	27,8	13,0
1213117	-1612	1"	1 5/16-12	3/4	52,0	25,0	50,8	23,8	11,0
1213118	-1616	1"	1 5/16-12	1	56,0	25,0	57,2	27,8	13,0
1213119	-1620	1"	1 5/16-12	1 1/4	56,0	31,0	66,7	31,8	15,0
1213120	-2016	1"1/4	1 5/8-12	1	58,0	31,0	57,2	27,8	13,0
1213121	-2020	1"1/4	1 5/8-12	1 1/4	63,0	31,0	66,7	31,8	15,0
1213122	-2024	1"1/4	1 5/8-12	1 1/2	67,0	37,0	79,4	36,5	17,0
1213123	-2420	1"1/2	1 7/8-12	1 1/4	63,0	37,0	66,7	31,8	15,0
1213124	-2424	1"1/2	1 7/8-12	1 1/2	70,0	37,0	79,4	36,5	17,0

Dimensions shown may be changed without prior notice

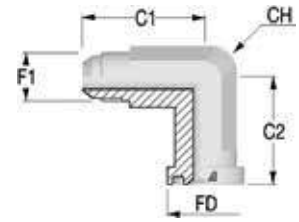
// R1A25M9334**90° adjustable split flange SAE J518 code 61 - JIC - Low pressure**

Item Code	Head / Flange	OD1 in	F1	Flange size	C1	C2	FD	CH
	Dash				mm	mm		
1213099	-0808	1/2"	3/4-16	1/2	48,0	42,0	30,2	22,0
1213100	-1008	5/8"	7/8-14	1/2	50,0	44,0	30,2	22,0
1213101	-1012	5/8"	7/8-14	3/4	64,0	53,0	38,1	22,0
1213102	-1212	3/4"	1 1/16-12	3/4	64,0	53,0	38,1	27,0
1213103	-1216	3/4"	1 1/16-12	1	65,0	60,0	44,5	27,0
1213104	-1612	1"	1 5/16-12	3/4	64,0	53,0	38,1	34,0
1213105	-1616	1"	1 5/16-12	1	65,0	60,0	44,5	34,0
1213106	-1620	1"	1 5/16-12	1 1/4	64,0	55,0	50,8	34,0
1213107	-2016	1"1/4	1 5/8-12	1	65,0	60,0	44,5	42,0
1213108	-2020	1"1/4	1 5/8-12	1 1/4	64,0	55,0	50,8	42,0
1213109	-2024	1"1/4	1 5/8-12	1 1/2	78,0	66,0	60,3	42,0
1213110	-2424	1"1/2	1 7/8-12	1 1/2	78,0	66,0	60,3	50,0

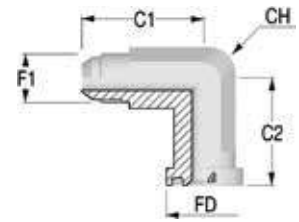
// R1A25M9364**90° adjustable split flange SAE J518 code 62 - JIC - High pressure**

Item Code	Head / Flange	OD1 in	F1	Flange size	C1	C2	FD	CH
	Dash				mm	mm		
1213125	-0808	1/2"	3/4-16	1/2	49,0	43,0	31,8	22,0
1213126	-1008	5/8"	7/8-14	1/2	50,0	44,0	31,8	22,0
1213127	-1012	5/8"	7/8-14	3/4	64,0	53,0	41,3	22,0
1213128	-1212	3/4"	1 1/16-12	3/4	64,0	53,0	41,3	27,0
1213129	-1216	3/4"	1 1/16-12	1	65,0	60,0	47,6	27,0
1213130	-1612	1"	1 5/16-12	3/4	64,0	53,0	41,3	34,0
1213131	-1616	1"	1 5/16-12	1	65,0	60,0	47,6	34,0
1213132	-1620	1"	1 5/16-12	1 1/4	64,0	55,0	54,0	34,0
1213133	-2016	1"1/4	1 5/8-12	1	65,0	60,0	47,6	42,0
1213134	-2020	1"1/4	1 5/8-12	1 1/4	64,0	55,0	54,0	42,0
1213135	-2024	1"1/4	1 5/8-12	1 1/2	78,0	66,0	63,5	42,0
1213136	-2424	1"1/2	1 7/8-12	1 1/2	78,0	66,0	63,5	50,0

// ACCESSORIES

// RXA25D0000

Nut JIC

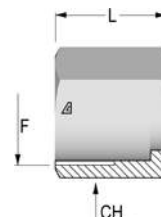

Item Code	Head	OD1 mm	F1	CH	L
	Dash			mm	mm
1208046	-0400	6	7/16-20	14,0	15,80
1208047	-0500	8	1/2-20	17,0	17,30
1207580	-0600	10	9/16-18	19,0	18,80
1208048	-0800	12	3/4-16	22,0	21,80
1208049	-1000	14	7/8-14	27,0	25,10
1208050	-1200	18	1 1/16-12	32,0	26,20
1203514	-1220	20	1 1/16-12	32,0	26,20
1208051	-1600	25	1 5/16-12	41,0	28,70
1208052	-2000	30	1 5/8-12	50,0	31,20
1208053	-2400	38	1 7/8-12	60,0	36,10

// R1A25R0000

Sleeve JIC



Item Code	Head	OD1 in	L
	Dash		mm
1203725	-0406	1/4"	10,5
1203719	-0508	5/16"	11,5
1203729	-0610	3/8"	12,5
1203724	-0812	1/2"	14,5
1203726	-1014	5/8"	16,5
1203727	-1015	5/8"	16,5
1203728	-1016	5/8"	16,5
1203717	-1218	3/4"	17,0
1203718	-1220	3/4"	17,0
1216495	-1422	7/8"	19,0
1203720	-1625	1"	19,5
1203721	-2030	1"1/4	23,0
1203722	-2032	1"1/4	23,0
1203723	-2438	1"1/2	28,5

Dimensions shown may be changed without prior notice

// PLUG

// R1A2531000

Cap JIC Female

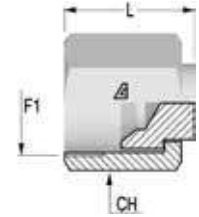

Item Code	Head	OD1	F1	CH	L
	Dash			in	
1207348	-0400	1/4"	7/16-20	14,0	17,0
1207349	-0500	5/16"	1/2-20	17,0	19,5
1207350	-0600	3/8"	9/16-18	19,0	20,5
1207351	-0800	1/2"	3/4-16	22,0	24,0
1207352	-1000	5/8"	7/8-14	27,0	27,0
1207353	-1200	3/4"	1 1/16-12	32,0	31,5
1213213	-1400	7/8"	1 3/16-12	36,0	32,0
1207354	-1600	1"	1 5/16-12	41,0	32,5
1207355	-2000	1"1/4	1 5/8-12	50,0	35,5
1207356	-2400	1"1/2	1 7/8-12	60,0	43,0

// R1A25M1000

Plug JIC Male

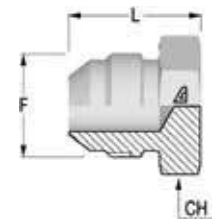

Item Code	Head	OD1	F1	CH	L
	Dash			in	
1207449	-0400	1/4"	7/16-20	12,0	20,5
1207450	-0500	5/16"	1/2-20	14,0	20,5
1207451	-0600	3/8"	9/16-18	14,0	21,5
1207452	-0800	1/2"	3/4-16	22,0	24,0
1207453	-1000	5/8"	7/8-14	24,0	28,0
1207454	-1200	3/4"	1 1/16-12	30,0	32,5
1212825	-1400	7/8"	1 3/16-12	33,0	33,0
1207455	-1600	1"	1 5/16-12	36,0	34,0
1207456	-2000	1"1/4	1 5/8-12	46,0	37,0
1207457	-2400	1"1/2	1 7/8-12	50,0	42,0



// ORFS ADAPTERS

// MALE UNION.....	235
// MALE / FEMALE UNION	237
// BULKHEAD.....	239
// BSPP	242
// METRIC.....	247

// SAE UNF	252
// FLANGES	257
// ACCESSORIES.....	260
// PLUG	261

Dimensions shown may be changed without prior notice

// MALE UNION

// R1A2451245

Straight union ORFS Male

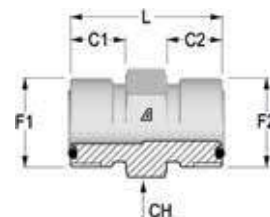

Item Code	Head 1 / Head 2	OD1	F1	F2	C1	C2	CH	L
	Dash	in						
1207586	-0404	1/4"	9/16-18	9/16-18	10,0	10,0	17,0	27,0
1208173	-0604	3/8"	11/16-16	9/16-18	11,0	10,0	19,0	30,0
1207587	-0606	3/8"	11/16-16	11/16-16	11,0	11,0	19,0	31,0
1208174	-0806	1/2"	13/16-16	11/16-16	13,0	11,0	22,0	33,5
1207579	-0808	1/2"	13/16-16	13/16-16	13,0	13,0	22,0	35,5
1208175	-1008	5/8"	1-14	13/16-16	15,5	13,0	27,0	40,0
1207588	-1010	5/8"	1-14	1-14	15,5	15,5	27,0	42,5
1208176	-1210	3/4"	1 3/16-12	1-14	17,0	15,5	32,0	45,5
1207589	-1212	3/4"	1 3/16-12	1 3/16-12	17,0	17,0	32,0	47,0
1208177	-1612	1"	1 7/16-12	13/16-16	17,5	17,0	41,0	49,5
1207590	-1616	1"	1 7/16-12	1 7/16-12	17,5	17,5	41,0	49,5
1208179	-2016	1 1/4"	1 11/16-12	1 7/16-12	17,5	17,5	46,0	51,5
1208180	-2020	1 1/4"	1 11/16-12	1 11/16-12	17,5	17,5	46,0	51,5
1211533	-2424	1 1/2"	2-12	2-12	17,5	17,5	55,0	53,0

// R1A2459245

90° union ORFS Male

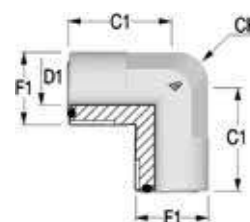

Item Code	Head 1 / Head 2	OD1	F1	C1	CH
	Dash	in			
1207045	-0404	1/4"	9/16-18	21,5	14,0
1208128	-0606	3/8"	11/16-16	25,0	17,0
1207578	-0808	1/2"	13/16-16	28,0	19,0
1208129	-1010	5/8"	1-14	33,5	27,0
1208130	-1212	3/4"	1 3/16-12	37,5	27,0
1208131	-1616	1"	1 7/16-12	42,0	36,0
1208132	-2020	1 1/4"	1 11/16-12	45,0	41,0
1211560	-2424	1 1/2"	2-12	49,0	48,0

// R1A245T245

Branch Tee union ORFS Male

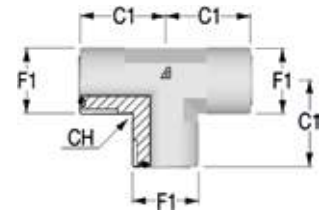

Item Code	Head 1 / Head 2	OD1	F1	C1	CH
	Dash	in		mm	mm
1207600	-0404	1/4"	9/16-18	21,5	14,0
1207601	-0606	3/8"	11/16-16	25,0	17,0
1207572	-0808	1/2"	13/16-16	28,0	19,0
1207571	-1010	5/8"	1-14	33,5	27,0
1208205	-1212	3/4"	1 3/16-12	37,5	27,0
1207602	-1616	1"	1 7/16-12	42,0	36,0
1208206	-2020	1"1/4	1 11/16-12	45,0	41,0
1211520	-2424	1"1/2	2-12	49,0	48,0

// R1A245X245

Cross union ORFS Male

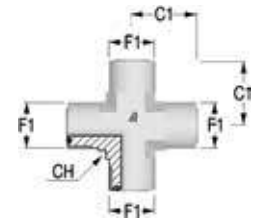

Item Code	Head 1 / Head 2	OD1	F1	C1	CH
	Dash	in		mm	mm
1212531	-0404	1/4"	9/16-18	21,5	14,0
1212532	-0606	3/8"	11/16-16	25,0	17,0
1212533	-0808	1/2"	13/16-16	28,0	19,0
1212534	-1010	5/8"	1-14	33,5	27,0
1212535	-1212	3/4"	1 3/16-12	37,5	27,0
1212536	-1616	1"	1 7/16-12	42,0	36,0
1212537	-2020	1"1/4	1 11/16-12	45,0	41,0
1212538	-2424	1"1/2	2-12	49,0	48,0

Dimensions shown may be changed without prior notice

// MALE / FEMALE UNION

// R1A2431245

Straight union ORFS Female - ORFS Male

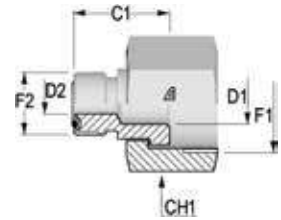

Item Code	Head 1 / Head 2	OD1 in	F1	F2	C1 mm	CH1 mm
	Dash					
1212498	-0604	3/8"	11/16-16	9/16-18	19,5	22,0
1208210	-0804	1/2"	13/16-16	9/16-18	22,0	24,0
1208347	-0806	1/2"	13/16-16	11/16-16	23,0	24,0
1207033	-1004	5/8"	1-14	9/16-18	23,0	30,0
1212518	-1006	5/8"	1-14	11/16-16	24,0	30,0
1207660	-1008	5/8"	1-14	13/16-16	26,0	30,0
1212519	-1204	3/4"	1 3/16-12	9/16-18	25,0	36,0
1208211	-1206	3/4"	1 3/16-12	11/16-16	26,0	36,0
1208212	-1208	3/4"	1 3/16-12	13/16-16	28,0	36,0
1214621	-1210	3/4"	1 3/16-12	1-14	30,5	36,0
1208213	-1608	1"	1 7/16-12	13/16-16	29,5	41,0
1207661	-1610	1"	1 7/16-12	1-14	32,0	41,0
1212499	-1612	1"	1 7/16-12	1 3/16-12	33,5	41,0
1208214	-2012	1"1/4	1 11/16-12	13/16-16	33,5	50,0
1208037	-2016	1"1/4	1 11/16-12	1 7/16-12	38,5	50,0
1211497	-2416	1"1/2	2-12	1 7/16-12	34,0	60,0
1211498	-2420	1"1/2	2-12	1 11/16-12	34,0	60,0

// R1A2454241

45° union ORFS Male - ORFS Female

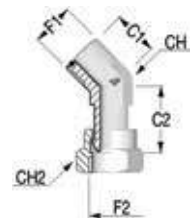

Item Code	Head 1 / Head 2	OD1 in	F1	C1 mm	C2 mm	CH mm	CH2 mm
	Dash						
1212613	-0404	1/4"	9/16-18	16,0	26,5	14,0	17,0
1212614	-0606	3/8"	11/16-16	19,0	25,0	17,0	22,0
1212615	-0808	1/2"	13/16-16	20,5	30,0	19,0	24,0
1212616	-1010	5/8"	1-14	23,5	40,4	27,0	30,0
1211542	-1212	3/4"	1 3/16-12	26,0	41,0	27,0	36,0
1212617	-1616	1"	1 7/16-12	30,0	45,0	36,0	41,0
1212618	-2020	1"1/4	1 11/16-12	32,0	45,0	41,0	50,0
1212619	-2424	1"1/2	2-12	37,0	47,0	48,0	60,0

// R1A2459241

90° union ORFS Male - ORFS Female

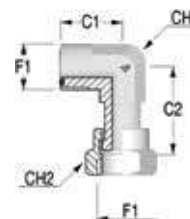

Item Code	Head 1 / Head 2	OD1	F1	C1	C2	CH	CH2
	Dash	in		mm	mm	mm	mm
1208021	-0404	1/4"	9/16-18	21,5	26,5	14,0	17,0
1207593	-0606	3/8"	11/16-16	25,0	29,0	17,0	22,0
1207569	-0808	1/2"	13/16-16	28,0	38,0	19,0	24,0
1206968	-1010	5/8"	1-14	33,5	41,5	27,0	30,0
1207594	-1212	3/4"	1 3/16-12	37,5	46,5	27,0	36,0
1207595	-1616	1"	1 7/16-12	41,5	53,5	36,0	41,0
1208126	-2020	1 1/4"	1 11/16-12	44,5	58,0	41,0	50,0
1211559	-2424	1 1/2"	2-12	49,0	61,0	48,0	60,0

// R1A245T241

Branch Tee union ORFS Male - ORFS Female

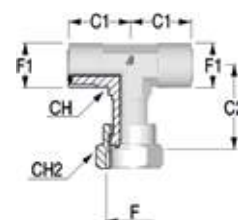

Item Code	Head 1 / Head 2	OD1	F1	C1	C2	CH	CH2
	Dash	in		mm	mm	mm	mm
1208200	-0404	1/4"	9/16-18	21,5	26,5	14,0	17,0
1208033	-0606	3/8"	11/16-16	25,0	29,0	17,0	22,0
1207570	-0808	1/2"	13/16-16	28,0	38,0	19,0	24,0
1208201	-1010	5/8"	1-14	33,5	41,5	27,0	30,0
1208202	-1212	3/4"	1 3/16-12	37,5	46,5	27,0	36,0
1208203	-1616	1"	1 7/16-12	41,5	53,5	36,0	41,0
1208204	-2020	1 1/4"	1 11/16-12	44,5	58,0	41,0	50,0
1211519	-2424	1 1/2"	2-12	49,0	61,0	48,0	60,0

// R1A245L241

Run Tee union ORFS Male - ORFS Female

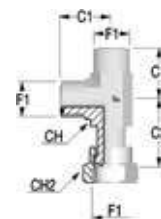

Item Code	Head 1 / Head 2	OD1	F1	C1	C2	CH	CH2
	Dash	in		mm	mm	mm	mm
1207597	-0404	1/4"	9/16-18	21,5	26,5	14,0	17,0
1207573	-0606	3/8"	11/16-16	25,0	29,0	17,0	22,0
1207598	-0808	1/2"	13/16-16	28,0	38,0	19,0	24,0
1207032	-1010	5/8"	1-14	33,5	41,5	27,0	30,0
1207559	-1212	3/4"	1 3/16-12	37,5	46,5	27,0	36,0
1207599	-1616	1"	1 7/16-12	41,5	53,5	36,0	41,0
1208209	-2020	1 1/4"	1 11/16-12	44,5	58,0	41,0	50,0
1211508	-2424	1 1/2"	2-12	49,0	61,0	48,0	60,0

Dimensions shown may be changed without prior notice

// BULKHEAD

// R1A245124T

Straight union ORFS Bulkhead

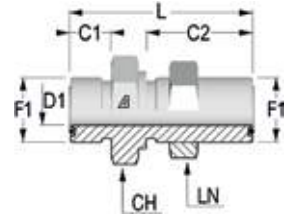

Item Code	Head 1 / Head 2	OD1 in	F1	C1	C2	CH	LN	L
	Dash			mm	mm	mm	mm	mm
1208184	-0404	1/4"	9/16-18	10,0	31,5	22,0	22,0	48,0
1207035	-0606	3/8"	11/16-16	11,0	34,0	27,0	27,0	53,0
1208185	-0808	1/2"	13/16-16	13,0	36,5	30,0	30,0	58,0
1239974	-0812	1/2"	13/16-16	13,0	41,5	41,0	41,0	65,0
1206967	-1010	5/8"	1-14	15,5	40,5	36,0	36,0	66,5
1208187	-1212	3/4"	1 3/16-12	17,0	41,5	41,0	41,0	69,0
1208188	-1616	1"	1 7/16-12	17,5	42,0	46,0	46,0	70,0
1208189	-2020	1 1/4"	1 11/16-12	17,5	42,0	50,0	50,0	70,0
1211532	-2424	1 1/2"	2-12	17,5	42,0	60,0	60,0	70,0

// R1A245424T

45° union ORFS Bulkhead

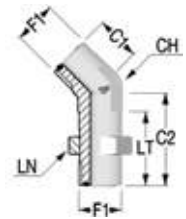

Item Code	Head 1 / Head 2	OD1 in	F1	C1	C2	CH	LN	LT
	Dash			mm	mm	mm	mm	mm
1212605	-0404	1/4"	9/16-18	16,0	44,0	14,0	22,0	31,5
1212606	-0606	3/8"	11/16-16	19,0	48,5	17,0	27,0	34,0
1212607	-0808	1/2"	13/16-16	20,5	51,0	19,0	30,0	36,5
1212608	-1010	5/8"	1-14	23,5	56,5	27,0	36,0	40,5
1212609	-1212	3/4"	1 3/16-12	26,0	60,5	27,0	41,0	41,5
1212610	-1616	1"	1 7/16-12	30,0	65,0	36,0	46,0	42,0
1212612	-2424	1 1/2"	2-12	37,0	67,0	48,0	60,0	42,0

// R1A245924T

90° union ORFS Bulkhead

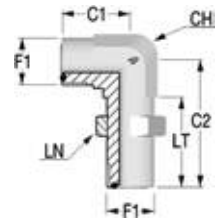

Item Code	Head 1 / Head 2	OD1	F1	C1	C2	CH	LN	LT
	Dash							
1210753	-0404	1/4"	9/16-18	22,5	47,0	14,0	22,0	31,5
1210754	-0606	3/8"	11/16-16	26,0	52,0	17,0	27,0	34,0
1210755	-0808	1/2"	13/16-16	29,0	55,5	19,0	30,0	36,5
1207560	-1010	5/8"	1-14	34,5	63,0	27,0	36,0	40,5
1208157	-1212	3/4"	1 3/16-12	38,5	67,0	27,0	41,0	41,5
1211557	-1616	1"	1 7/16-12	42,5	71,0	36,0	46,0	42,0
1208158	-2020	1"1/4	1 11/16-12	45,5	75,5	41,0	50,0	42,0
1211558	-2424	1"1/2	2-12	49,5	79,5	48,0	60,0	42,0

// R1A245T24T

Branch Tee union ORFS Bulkhead

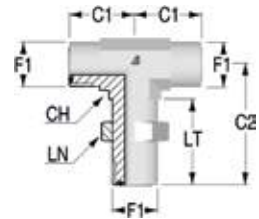

Item Code	Head 1 / Head 2	OD1	F1	C1	C2	CH	LN	LT
	Dash							
1212524	-0404	1/4"	9/16-18	22,5	47,0	14,0	22,0	31,5
1212525	-0606	3/8"	11/16-16	26,0	52,0	17,0	27,0	34,0
1208224	-0808	1/2"	13/16-16	29,0	55,5	19,0	30,0	36,5
1212526	-1010	5/8"	1-14	34,5	63,0	27,0	36,0	40,5
1212527	-1212	3/4"	1 3/16-12	38,5	67,0	27,0	41,0	41,5
1212528	-1616	1"	1 7/16-12	42,5	71,0	36,0	46,0	42,0
1212529	-2020	1"1/4	1 11/16-12	45,5	75,5	41,0	50,0	42,0
1212530	-2424	1"1/2	2-12	49,5	79,5	48,0	60,0	42,0

Dimensions shown may be changed without prior notice

// R1A245L24T

Run Tee union ORFS Bulkhead

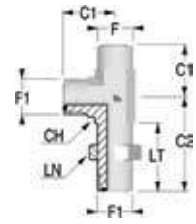

Item Code	Head 1 / Head 2	OD1	F1	C1	C2	CH	LN	LT
	Dash	in		mm	mm	mm	mm	mm
1240057	-0404	1/4"	9/16-18	22,5	47,0	14,0	22,0	35,0
1211502	-0606	3/8"	11/16-16	26,0	52,0	17,0	27,0	39,0
1210797	-0808	1/2"	13/16-16	29,0	55,5	19,0	30,0	40,0
1211503	-1010	5/8"	1-14	34,5	63,0	27,0	36,0	43,5
1211504	-1212	3/4"	1 3/16-12	38,5	67,0	27,0	41,0	44,5
1211505	-1616	1"	1 7/16-12	42,5	71,0	36,0	46,0	46,0
1211506	-2020	1"1/4	1 11/16-12	45,5	75,5	41,0	50,0	46,5
1211507	-2424	1"1/2	2-12	49,5	79,5	48,0	60,0	45,0

// BSPP

// R1A245106I

Straight connector ORFS Male - BSPP cylindric Male with elastomer

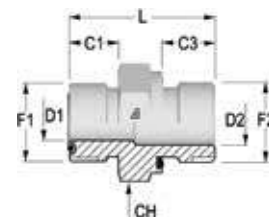

Item Code	Head 1 / Head 2	OD1 in	F1	F2	C1 mm	C2 mm	CH mm	L mm
	Dash							
1207990	-0402	1/4"	9/16-18	1/8-28	10,0	8,0	17,0	25,5
1206956	-0404	1/4"	9/16-18	1/4-19	10,0	12,0	19,0	30,5
1206957	-0406	1/4"	9/16-18	3/8-19	10,0	12,0	22,0	31,5
1208017	-0408	1/4"	9/16-18	1/2-14	10,0	14,0	27,0	35,5
1207575	-0604	3/8"	11/16-16	1/4-19	11,0	12,0	19,0	31,5
1207574	-0606	3/8"	11/16-16	3/8-19	11,0	12,0	22,0	33,5
1207996	-0608	3/8"	11/16-16	1/2-14	11,0	14,0	27,0	37,0
1207998	-0804	1/2"	13/16-16	1/4-19	13,0	12,0	22,0	39,5
1207576	-0806	1/2"	13/16-16	3/8-19	13,0	12,0	22,0	34,5
1206958	-0808	1/2"	13/16-16	1/2-14	13,0	14,0	27,0	38,5
1208022	-0812	1/2"	13/16-16	3/4-14	13,0	16,0	32,0	42,0
1207999	-1006	5/8"	1-14	3/8-19	15,5	12,0	27,0	43,0
1208010	-1008	5/8"	1-14	1/2-14	15,5	14,0	27,0	41,0
1207959	-1012	5/8"	1-14	3/4-14	15,5	16,0	32,0	44,5
1208000	-1208	3/4"	1 3/16-12	1/2-14	17,0	14,0	32,0	48,5
1206955	-1212	3/4"	1 3/16-12	3/4-14	17,0	16,0	32,0	46,0
1211527	-1216	3/4"	1 3/16-12	1-11	17,0	18,0	41,0	49,5
1208003	-1612	1"	1 7/16-12	3/4-14	17,5	16,0	41,0	51,0
1207577	-1616	1"	1 7/16-12	1-11	17,5	18,0	41,0	49,0
1207979	-1620	1"	1 7/16-12	1 1/4-11	17,5	20,0	50,0	54,0
1208034	-2016	1 1/4"	1 11/16-12	1-11	17,5	18,0	46,0	57,5
1208018	-2020	1 1/4"	1 11/16-12	1 1/4-11	17,5	20,0	50,0	54,0
1211528	-2024	1 1/4"	1 11/16-12	1 1/2-11	17,5	22,0	55,0	57,5
1211529	-2424	1 1/2"	2-12	1 1/2-11	17,5	22,0	55,0	57,5

Dimensions shown may be changed without prior notice

// R1A245406N

**45° adjustable elbow connector ORFS Male - BSPP cylindric
Male with O-Ring and retaining ring**

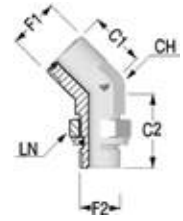

Item Code	Head 1 / Head 2	OD1	F1	F2	C1	C2	CH	LN
	Dash	in						
1210800	-0402	1/4"	9/16-18	1/8-28	16,0	28,0	14,0	14,0
1210801	-0404	1/4"	9/16-18	1/4-19	17,5	31,0	14,0	19,0
1210802	-0604	3/8"	11/16-16	1/4-19	19,0	32,0	19,0	19,0
1210803	-0606	3/8"	11/16-16	3/8-19	19,0	33,0	19,0	22,0
1210804	-0608	3/8"	11/16-16	1/2-14	19,5	43,0	27,0	27,0
1210805	-0806	1/2"	13/16-16	3/8-19	20,5	33,5	19,0	22,0
1212604	-0808	1/2"	13/16-16	1/2-14	22,0	42,0	27,0	27,0
1210806	-1008	5/8"	1-14	1/2-14	23,5	42,0	27,0	27,0
1210807	-1012	5/8"	1-14	3/4-14	24,5	46,5	30,0	32,0
1210733	-1212	3/4"	1 3/16-12	3/4-14	26,0	50,0	30,0	36,0
1211539	-1216	3/4"	1 3/16-12	1-11	29,5	52,5	36,0	41,0
1207720	-1616	1"	1 7/16-12	1-11	30,0	52,5	36,0	41,0
1211540	-2020	1"1/4	1 11/16-12	1 1/4-11	32,0	53,5	41,0	50,0
1211541	-2424	1"1/2	2-12	1 1/2-11	37,0	53,5	48,0	55,0

// R1A245906N

90° adjustable elbow connector ORFS Male - BSPP cylindrical
Male with O-Ring and retaining ring

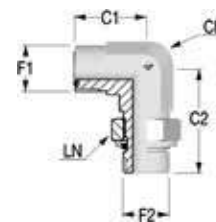

Item Code	Head 1 / Head 2	OD1 in	F1	F2	C1	C2	CH	LN
	Dash				mm	mm	mm	mm
1210739	-0402	1/4"	9/16-18	1/8-28	21,5	30,0	14,0	14,0
1207721	-0404	1/4"	9/16-18	1/4-19	23,5	35,0	14,0	19,0
1207581	-0406	1/4"	9/16-18	3/8-19	25,0	38,0	19,0	22,0
1207722	-0604	3/8"	11/16-16	1/4-19	25,0	36,0	19,0	19,0
1207568	-0606	3/8"	11/16-16	3/8-19	26,5	38,0	19,0	22,0
1207567	-0608	3/8"	11/16-16	1/2-14	29,5	48,0	27,0	27,0
1207723	-0804	1/2"	13/16-16	1/4-19	28,0	35,0	19,0	19,0
1207724	-0806	1/2"	13/16-16	3/8-19	28,0	38,0	19,0	22,0
1207725	-0808	1/2"	13/16-16	1/2-14	31,0	48,0	27,0	27,0
1208118	-1006	5/8"	1-14	3/8-19	33,5	43,0	27,0	22,0
1207034	-1008	5/8"	1-14	1/2-14	33,5	48,0	27,0	27,0
1210741	-1012	5/8"	1-14	3/4-14	36,0	51,5	30,0	32,0
1208029	-1208	3/4"	1 3/16-12	1/2-14	37,5	49,5	30,0	27,0
1207557	-1212	3/4"	1 3/16-12	3/4-14	37,5	51,5	30,0	36,0
1208119	-1216	3/4"	1 3/16-12	1-11	41,5	58,0	36,0	41,0
1210714	-1612	1"	1 7/16-12	3/4-14	42,0	56,0	36,0	32,0
1208121	-1616	1"	1 7/16-12	1-11	42,0	58,0	36,0	41,0
1211552	-1620	1"	1 7/16-12	1 1/4-11	45,0	60,5	41,0	50,0
1211553	-2016	1 1/4"	1 11/16-12	1-11	45,0	60,0	41,0	41,0
1211554	-2020	1 1/4"	1 11/16-12	1 1/4-11	45,0	60,5	41,0	50,0
1211555	-2024	1 1/4"	1 11/16-12	1 1/2-11	49,0	64,5	48,0	55,0
1211556	-2424	1 1/2"	2-12	1 1/2-11	49,0	64,5	48,0	55,0

Dimensions shown may be changed without prior notice

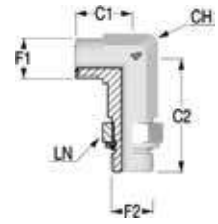
// R1A245906Y**90° adjustable long elbow connector ORFS Male - BSPP
cylindric Male with O-Ring and retaining ring**

Item Code	Head 1 / Head 2	OD1	F1	F2	C1	C2	CH	LN
	Dash	in			mm	mm	mm	mm
1212620	-0404	1/4"	9/16-18	1/4-19	23,5	59,0	14,0	19,0
1212621	-0406	1/4"	9/16-18	3/8-19	25,0	62,0	19,0	22,0
1212622	-0606	3/8"	11/16-16	3/8-19	26,5	67,0	19,0	22,0
1212623	-0608	3/8"	11/16-16	1/2-14	29,5	77,0	27,0	27,0
1212624	-0806	1/2"	13/16-16	3/8-19	28,0	73,0	19,0	22,0
1212625	-0808	1/2"	13/16-16	1/2-14	31,0	82,0	27,0	27,0
1212626	-1008	5/8"	1-14	1/2-14	33,5	87,0	27,0	27,0
1212627	-1012	5/8"	1-14	3/4-14	36,0	90,0	30,0	32,0
1212628	-1212	3/4"	1 3/16-12	3/4-14	37,5	97,0	30,0	36,0
1212629	-1216	3/4"	1 3/16-12	1-11	41,5	104,0	36,0	41,0
1212630	-1616	1"	1 7/16-12	1-11	42,0	112,0	36,0	41,0
1212631	-1620	1"	1 7/16-12	1 1/4-11	45,0	113,0	41,0	50,0
1212632	-2020	1 1/4"	1 11/16-12	1 1/4-11	45,0	123,0	41,0	50,0
1212633	-2024	1 1/4"	1 11/16-12	1 1/2-11	49,0	128,0	48,0	55,0
1212634	-2424	1 1/2"	2-12	1 1/2-11	49,0	137,0	48,0	55,0

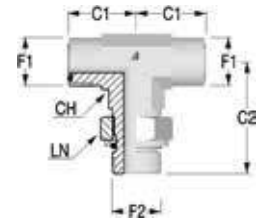
// R1A245T06N**Branch Tee adjustable elbow connector ORFS Male - BSPP
cylindric Male with O-Ring and retaining ring**

Item Code	Head 1 / Head 2	OD1	F1	F2	C1	C2	CH	LN
	Dash	in			mm	mm	mm	mm
1210825	-0402	1/4"	9/16-18	9/16-18	21,5	30,0	14,0	14,0
1210826	-0404	1/4"	9/16-18	9/16-18	23,5	35,0	14,0	19,0
1210827	-0604	3/8"	11/16-16	11/16-16	25,0	36,0	19,0	19,0
1210828	-0606	3/8"	11/16-16	11/16-16	26,5	38,0	19,0	22,0
1210829	-0806	1/2"	13/16-16	13/16-16	28,0	38,0	19,0	22,0
1212523	-0808	1/2"	13/16-16	13/16-16	31,0	48,0	27,0	27,0
1207726	-1008	5/8"	1-14	1-14	33,5	48,0	27,0	27,0
1210830	-1012	5/8"	1-14	1-14	36,0	51,5	30,0	32,0
1207558	-1212	3/4"	1 3/16-12	1 3/16-12	37,5	51,5	30,0	36,0
1211516	-1616	1"	1 7/16-12	1 7/16-12	42,0	58,0	36,0	41,0
1211517	-2020	1 1/4"	1 11/16-12	1 11/16-12	45,0	60,5	41,0	50,0
1211518	-2424	1 1/2"	2-12	2-12	49,0	64,5	48,0	55,0

// R1A245L06N

**Run Tee adjustable elbow connector ORFS Male - BSPP
cylindric Male with O-Ring and retaining ring**

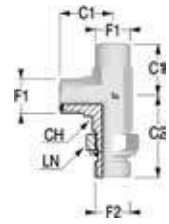

Item Code	Head 1 / Head 2	OD1	F1	F2	C1	C2	CH	LN
	Dash	in			mm	mm	mm	mm
1210789	-0402	1/4"	9/16-18	1/8-28	21,5	30,0	14,0	14,0
1210791	-0604	3/8"	11/16-16	1/4-19	25,0	36,0	19,0	19,0
1210792	-0606	3/8"	11/16-16	3/8-19	26,5	38,0	19,0	22,0
1211499	-0806	1/2"	13/16-16	3/8-19	28,0	38,0	19,0	22,0
1210793	-0808	1/2"	13/16-16	1/2-14	31,0	48,0	27,0	27,0
1210794	-1008	5/8"	1-14	1/2-14	33,5	48,0	27,0	27,0
1210795	-1012	5/8"	1-14	3/4-14	36,0	51,5	30,0	32,0
1210796	-1212	3/4"	1 3/16-12	3/4-14	37,5	51,5	30,0	36,0
1208208	-1616	1"	1 7/16-12	1-11	42,0	58,0	36,0	41,0
1211500	-2020	1"1/4	1 11/16-12	1 1/4-11	45,0	60,5	41,0	50,0
1211501	-2424	1"1/2	2-12	1 1/2-11	49,0	64,5	48,0	55,0

Dimensions shown may be changed without prior notice

// METRIC

// R1A2451525

Straight connector ORFS Male - Metric Male with O-Ring

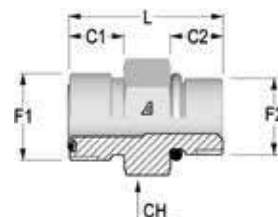

Item Code	Head 1 / Head 2	OD1	F1	F2	C1	C2	CH	L
	Dash	in						
1216267	-0410	1/4"	9/16-18	M10X1.0	10,0	9,0	17,0	27,0
1216268	-0412	1/4"	9/16-18	M12X1.5	10,0	11,0	17,0	28,5
1208019	-0414	1/4"	9/16-18	M14X1.5	10,0	11,0	19,0	29,5
1207957	-0614	3/8"	11/16-16	M14X1.5	11,0	11,0	22,0	32,0
1208032	-0616	3/8"	11/16-16	M16X1.5	11,0	12,5	22,0	33,5
1216270	-0618	3/8"	11/16-16	M18X1.5	11,0	13,5	24,0	36,0
1207956	-0814	1/2"	13/16-16	M14X1.5	13,0	11,0	22,0	35,0
1216272	-0816	1/2"	13/16-16	M16X1.5	13,0	12,5	22,0	36,5
1208040	-0818	1/2"	13/16-16	M18X1.5	13,0	13,5	24,0	38,0
1211538	-0822	1/2"	13/16-16	M22X1.5	13,0	15,0	27,0	38,5
1208020	-1022	5/8"	1-14	M22X1.5	15,5	15,0	27,0	42,0
1216274	-1027	5/8"	1-14	M27X2	15,5	18,5	32,0	47,0
1216276	-1227	3/4"	1 3/16-12	M27X2	17,0	18,5	32,0	48,5
1216277	-1233	3/4"	1 3/16-12	M33X2.0	17,0	18,5	41,0	51,5
1216278	-1633	1"	1 7/16-12	M33X2.0	17,5	18,5	41,0	52,0
1216279	-1642	1"	1 7/16-12	M42X2	17,5	18,5	50,0	54,5
1216280	-2042	1"1/4	1 11/16-12	M42X2	17,5	18,5	50,0	54,5
1216281	-2048	1"1/4	1 11/16-12	M48X2.0	17,5	18,5	55,0	55,5
1216282	-2448	1"1/2	2-12	M48X2.0	17,5	18,5	55,0	57,0

// R1A245152I

Straight connector ORFS Male - Metric Male with elastomer

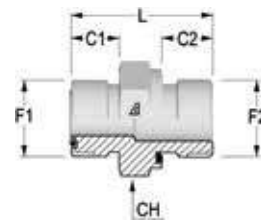

Item Code	Head 1 / Head 2	OD1 in	F1	F2	C1	C2	CH mm	L mm
	Dash				mm	mm		
1206959	-0410	1/4"	9/16-18	M10X1.0	10,0	8,0	17,0	25,0
1206960	-0412	1/4"	9/16-18	M12X1.5	10,0	12,0	17,0	29,5
1208035	-0414	1/4"	9/16-18	M14X1.5	10,0	12,0	19,0	30,5
1208036	-0614	3/8"	11/16-16	M14X1.5	11,0	12,0	22,0	32,0
1206961	-0616	3/8"	11/16-16	M16X1.5	11,0	12,0	22,0	32,0
1212592	-0814	1/2"	13/16-16	M14X1.5	13,0	12,0	22,0	34,0
1216283	-0816	1/2"	13/16-16	M16X1.5	13,0	12,0	22,0	34,0
1206962	-0818	1/2"	13/16-16	M18X1.5	13,0	12,0	24,0	36,5
1212593	-0822	1/2"	13/16-16	M22X1.5	13,0	14,0	27,0	38,5
1208191	-1022	5/8"	1-14	M22X1.5	15,5	14,0	27,0	41,0
1212594	-1222	3/4"	1 3/16-12	M22X1.5	17,0	14,0	32,0	44,0
1208192	-1227	3/4"	1 3/16-12	M27X2	17,0	16,0	32,0	46,0
1211535	-1633	1"	1 7/16-12	M33X2.0	17,5	18,0	41,0	50,0
1212597	-1642	1"	1 7/16-12	M42X2	17,5	20,0	50,0	54,0
1211536	-2042	1"1/4	1 11/16-12	M42X2	17,5	20,0	50,0	54,0
1211537	-2448	1"1/2	2-12	M48X2.0	17,5	22,0	55,0	57,5

Dimensions shown may be changed without prior notice

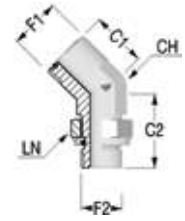
// R1A245452Q**45° adjustable elbow connector ORFS Male - Metric Male with O-Ring and retaining ring**

Item Code	Head 1 / Head 2	OD1	F1	F2	C1	C2	CH	LN
	Dash	in			mm	mm		
1210736	-0412	1/4"	9/16-18	M12X1.5	16,0	30,0	14,0	17,0
1208115	-0616	3/8"	11/16-16	M16X1.5	19,0	33,5	17,0	22,0
1210737	-0818	1/2"	13/16-16	M18X1.5	20,5	37,0	19,0	24,0
1210738	-1022	5/8"	1-14	M22X1.5	23,5	44,0	27,0	27,0
1211548	-1227	3/4"	1 3/16-12	M27X2	26,0	50,5	27,0	32,0
1211549	-1633	1"	1 7/16-12	M33X2.0	30,0	52,5	36,0	41,0
1211550	-2042	1"1/4	1 11/16-12	M42X2	32,0	54,0	41,0	50,0
1211551	-2448	1"1/2	2-12	M48X2.0	37,0	56,5	48,0	55,0

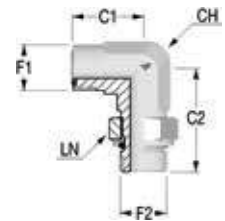
// R1A245952Q**90° adjustable elbow connector ORFS Male - Metric Male with O-Ring and retaining ring**

Item Code	Head 1 / Head 2	OD1	F1	F2	C1	C2	CH	LN
	Dash	in			mm	mm		
1210758	-0410	1/4"	9/16-18	M10X1.0	21,5	32,5	14,0	14,0
1208159	-0412	1/4"	9/16-18	M12X1.5	21,5	33,0	14,0	17,0
1212692	-0612	3/8"	11/16-16	M12X1.5	25,0	35,5	17,0	17,0
1208042	-0614	3/8"	11/16-16	M14X1.5	25,0	35,5	17,0	19,0
1208043	-0616	3/8"	11/16-16	M16X1.5	25,0	37,5	17,0	22,0
1210759	-0818	1/2"	13/16-16	M18X1.5	28,0	41,0	19,0	24,0
1210760	-0822	1/2"	13/16-16	M22X1.5	31,0	49,0	19,0	27,0
1210761	-1022	5/8"	1-14	M22X1.5	33,5	49,0	27,0	27,0
1210762	-1027	5/8"	1-14	M27X2	33,5	55,0	27,0	32,0
1210763	-1227	3/4"	1 3/16-12	M27X2	37,5	55,5	27,0	32,0
1210764	-1233	3/4"	1 3/16-12	M33X2.0	37,5	59,5	36,0	41,0
1212693	-1627	1"	1 7/16-12	M27X2	41,5	59,5	36,0	32,0
1211568	-1633	1"	1 7/16-12	M33X2.0	41,5	59,5	36,0	41,0
1211569	-1642	1"	1 7/16-12	M42X2	41,5	62,0	41,0	50,0
1211570	-2042	1"1/4	1 11/16-12	M42X2	44,5	63,0	41,0	50,0
1211571	-2048	1"1/4	1 11/16-12	M48X2.0	44,5	71,5	48,0	55,0
1211572	-2448	1"1/2	2-12	M48X2.0	49,0	71,5	48,0	55,0

// R1A245952Y

90° adjustable long elbow connector ORFS Male - Metric Male with O-Ring and retaining ring

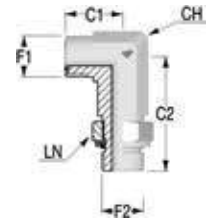

Item Code	Head 1 / Head 2	OD1	F1	F2	C1	C2	CH	LN
	Dash				in	mm		
1212694	-0412	1/4"	9/16-18	M12X1.5	21,5	56,5	14,0	17,0
1212695	-0616	3/8"	11/16-16	M16X1.5	25,0	67,0	17,0	22,0
1212696	-0818	1/2"	13/16-16	M18X1.5	28,0	75,0	19,0	24,0
1212697	-1022	5/8"	1-14	M22X1.5	33,5	89,0	27,0	27,0
1212698	-1227	3/4"	1 3/16-12	M27X2	37,5	100,0	27,0	32,0
1212699	-1633	1"	1 7/16-12	M33X2.0	41,5	113,0	36,0	41,0
1212700	-2042	1"1/4	1 11/16-12	M42X2	44,5	125,0	41,0	50,0
1212701	-2448	1"1/2	2-12	M48X2.0	49,0	139,0	48,0	55,0

// R1A245T52Q

Branch Tee adjustable elbow connector ORFS Male - Metric Male with O-Ring and retaining ring

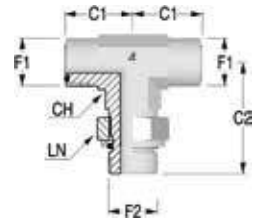

Item Code	Head 1 / Head 2	OD1	F1	F2	C1	C2	CH	LN
	Dash				in	mm		
1210784	-0412	1/4"	9/16-18	9/16-18	21,5	33,0	14,0	17,0
1210785	-0616	3/8"	11/16-16	11/16-16	25,0	37,5	17,0	22,0
1210786	-0818	1/2"	13/16-16	13/16-16	28,0	41,0	19,0	24,0
1210787	-1022	5/8"	1-14	1-14	33,5	49,0	27,0	27,0
1210788	-1227	3/4"	1 3/16-12	1 3/16-12	37,5	55,5	27,0	32,0
1211524	-1633	1"	1 7/16-12	1 7/16-12	41,5	59,5	36,0	41,0
1211525	-2042	1"1/4	1 11/16-12	1 11/16-12	44,5	63,0	41,0	50,0
1211526	-2448	1"1/2	2-12	2-12	49,0	71,5	48,0	55,0

Dimensions shown may be changed without prior notice

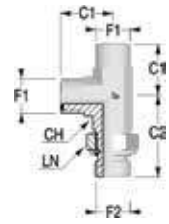
// R1A245L52Q**Run Tee adjustable elbow connector ORFS Male - Metric Male
with O-Ring and retaining ring**

Item Code	Head 1 / Head 2	OD1	F1	F2	C1	C2	CH	LN
	Dash	in			mm	mm	mm	mm
1210820	-0412	1/4"	9/16-18	M12X1.5	21,5	33,0	14,0	17,0
1210821	-0616	3/8"	11/16-16	M16X1.5	25,0	37,5	17,0	22,0
1210822	-0818	1/2"	13/16-16	M18X1.5	28,0	41,0	19,0	24,0
1210709	-1022	5/8"	1-14	M22X1.5	33,5	49,0	27,0	27,0
1210823	-1227	3/4"	1 3/16-12	M27X2	37,5	55,5	27,0	32,0
1211513	-1633	1"	1 7/16-12	M33X2.0	41,5	59,5	36,0	41,0
1211514	-2042	1"1/4	1 11/16-12	M42X2	44,5	63,0	41,0	50,0
1211515	-2448	1"1/2	2-12	M48X2.0	49,0	71,5	48,0	55,0

// SAE UNF

// R1A245130S

Straight connector ORFS Male - SAE UNF/UN Male with O-Ring

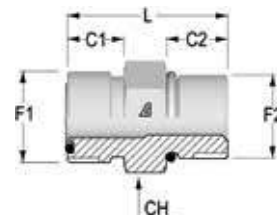

Item Code	Head 1 / Head 2	OD1 in	F1	F2	C1	C2	CH mm	L mm
	Dash				mm	mm		
1206963	-0404	1/4"	9/16-18	7/16-20	10,0	11,0	17,0	29,0
1206964	-0406	1/4"	9/16-18	9/16-18	10,0	12,0	19,0	30,5
1212564	-0604	3/8"	11/16-16	7/16-20	11,0	11,0	19,0	34,0
1207972	-0606	3/8"	11/16-16	9/16-18	11,0	12,0	22,0	32,0
1210723	-0608	3/8"	11/16-16	3/4-16	11,0	14,0	22,0	35,0
1208012	-0806	1/2"	13/16-16	9/16-18	13,0	12,0	22,0	37,5
1208013	-0808	1/2"	13/16-16	3/4-16	13,0	14,0	22,0	36,5
1207973	-0810	1/2"	13/16-16	7/8-14	13,0	16,0	27,0	40,5
1212565	-0812	1/2"	13/16-16	1 1/16-12	13,0	18,5	32,0	44,5
1208014	-1008	5/8"	1-14	3/4-16	15,5	14,0	27,0	45,0
1206965	-1010	5/8"	1-14	7/8-14	15,5	16,0	27,0	43,0
1207968	-1012	5/8"	1-14	1 1/16-12	15,5	18,5	32,0	47,0
1212566	-1210	3/4"	1 3/16-12	7/8-14	17,0	16,0	32,0	50,5
1207592	-1212	3/4"	1 3/16-12	1 1/16-12	17,0	18,0	32,0	48,5
1207561	-1216	3/4"	1 3/16-12	1 5/16-12	17,0	18,5	41,0	50,0
1212567	-1220	3/4"	1 3/16-12	1 5/8-12	17,0	18,5	46,0	50,5
1210721	-1612	1"	1 7/16-12	1 1/16-12	17,5	18,5	41,0	54,0
1208015	-1616	1"	1 7/16-12	1 5/16-12	17,5	18,5	41,0	50,5
1210777	-1620	1"	1 7/16-12	1 5/8-12	17,5	18,5	46,0	52,0
1212568	-2016	1 1/4"	1 11/16-12	1 5/16-12	17,5	18,5	46,0	58,0
1210778	-2020	1 1/4"	1 11/16-12	1 5/8-12	17,5	18,5	46,0	52,0
1211534	-2424	1 1/2"	2-12	1 7/8-12	17,5	18,5	55,0	54,0

// R1A245130J

Long connector ORFS Male - SAE UNF/UN Male with O-Ring

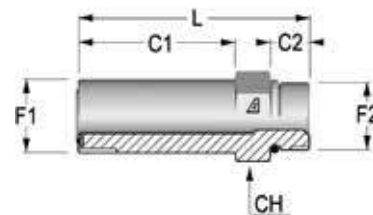

Item Code	Head 1 / Head 2	OD1 in	F1	F2	C1	C2	CH mm	L mm
	Dash				mm	mm		
1212556	-0404	1/4"	9/16-18	7/16-20	34,0	9,0	17,0	52,5
1212557	-0606	3/8"	11/16-16	9/16-18	37,0	10,0	22,0	58,0
1212558	-0808	1/2"	13/16-16	3/4-16	44,0	11,0	22,0	68,0
1212559	-1010	5/8"	1-14	7/8-14	52,0	12,5	27,0	79,5
1212560	-1212	3/4"	1 3/16-12	1 1/16-12	64,0	15,0	32,0	95,5
1212561	-1616	1"	1 7/16-12	1 5/16-12	72,5	15,0	41,0	105,0
1212562	-2020	1 1/4"	1 11/16-12	1 5/8-12	86,0	15,0	46,0	121,0
1212563	-2424	1 1/2"	2-12	1 7/8-12	97,0	15,0	55,0	133,5

Dimensions shown may be changed without prior notice

// R1A2454305

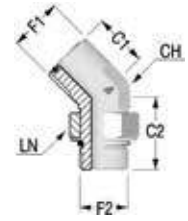
45° adjustable elbow connector ORFS Male - SAE UNF/UN Male with O-Ring

Item Code	Head 1 / Head 2	OD1	F1	F2	C1	C2	CH	LN
	Dash	in						
1210808	-0404	1/4"	9/16-18	7/16-20	16,0	30,0	14,0	16,0
1210809	-0406	1/4"	9/16-18	9/16-18	17,5	33,0	14,0	19,0
1210810	-0604	3/8"	11/16-16	7/16-20	19,0	31,0	17,0	16,0
1210722	-0606	3/8"	11/16-16	9/16-18	19,0	33,0	17,0	19,0
1207936	-0608	3/8"	11/16-16	3/4-16	19,0	36,5	19,0	24,0
1210811	-0806	1/2"	13/16-16	9/16-18	20,5	32,5	19,0	19,0
1210812	-0808	1/2"	13/16-16	3/4-16	20,5	36,5	19,0	24,0
1210813	-0810	1/2"	13/16-16	7/8-14	21,0	45,0	22,0	27,0
1211543	-1008	5/8"	1-14	3/4-16	23,5	40,5	27,0	24,0
1210814	-1010	5/8"	1-14	7/8-14	23,5	45,0	27,0	27,0
1210815	-1012	5/8"	1-14	1 1/16-12	24,5	50,0	27,0	32,0
1210816	-1210	3/4"	1 3/16-12	7/8-14	26,0	46,0	30,0	27,0
1207975	-1212	3/4"	1 3/16-12	1 1/16-12	26,0	44,0	27,0	32,0
1211544	-1216	3/4"	1 3/16-12	1 5/16-12	29,5	52,5	36,0	41,0
1207974	-1612	1"	1 7/16-12	1 1/16-12	30,0	51,5	33,0	32,0
1210817	-1616	1"	1 7/16-12	1 5/16-12	30,0	52,5	36,0	41,0
1211545	-1620	1"	1 7/16-12	1 5/8-12	32,0	53,5	41,0	50,0
1211546	-2020	1 1/4"	1 11/16-12	1 5/8-12	32,0	48,5	41,0	50,0
1211547	-2424	1 1/2"	2-12	1 7/8-12	33,5	48,5	48,0	55,0

// R1A2459305

90° adjustable elbow connector ORFS Male - SAE UNF/UN Male
with O-Ring

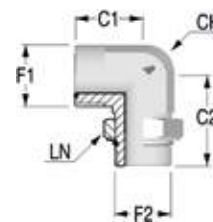

Item Code	Head 1 / Head 2	OD1	F1	F2	C1	C2	CH	LN
	Dash	in			mm	mm	mm	mm
1207980	-0404	1/4"	9/16-18	7/16-20	22,5	32,5	14,0	16,0
1207976	-0406	1/4"	9/16-18	9/16-18	23,5	37,0	14,0	19,0
1208016	-0604	3/8"	11/16-16	7/16-20	25,0	35,0	17,0	17,0
1207497	-0606	3/8"	11/16-16	9/16-18	25,0	37,0	17,0	19,0
1210724	-0608	3/8"	11/16-16	3/4-16	26,5	40,5	19,0	24,0
1210725	-0806	1/2"	13/16-16	9/16-18	28,0	36,5	19,0	19,0
1207596	-0808	1/2"	13/16-16	3/4-16	28,0	40,5	19,0	24,0
1207970	-0810	1/2"	13/16-16	7/8-14	31,0	50,0	22,0	27,0
1210726	-1008	5/8"	1-14	3/4-16	33,5	46,0	27,0	24,0
1207971	-1010	5/8"	1-14	7/8-14	33,5	50,0	27,0	27,0
1207969	-1012	5/8"	1-14	1 1/16-12	36,0	55,0	27,0	32,0
1210756	-1210	3/4"	1 3/16-12	7/8-14	37,5	51,0	30,0	27,0
1207977	-1212	3/4"	1 3/16-12	1 1/16-12	37,5	55,0	30,0	32,0
1210711	-1216	3/4"	1 3/16-12	1 5/16-12	41,5	60,0	36,0	41,0
1207978	-1612	1"	1 7/16-12	1 1/16-12	42,0	59,0	33,0	32,0
1210757	-1616	1"	1 7/16-12	1 5/16-12	42,0	60,0	36,0	41,0
1211561	-1620	1"	1 7/16-12	1 5/8-12	45,0	62,0	41,0	50,0
1211562	-2016	1"1/4	1 11/16-12	1 5/16-12	45,0	62,0	41,0	41,0
1211563	-2020	1"1/4	1 11/16-12	1 5/8-12	44,5	62,0	41,0	50,0
1211564	-2024	1"1/4	1 11/16-12	1 7/8-12	49,0	66,0	48,0	55,0
1211565	-2424	1"1/2	2-12	1 7/8-12	49,0	66,0	48,0	55,0

Dimensions shown may be changed without prior notice

// R1A245930J

90° adjustable long elbow connector ORFS Male - SAE UNF/UN
Male with O-Ring

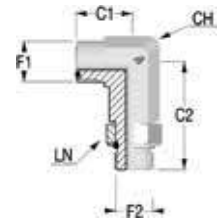

Item Code	Head 1 / Head 2	OD1 in	F1	F2	C1	C2	CH	LN
	Dash				mm	mm	mm	mm
1212635	-0404	1/4"	9/16-18	7/16-20	21,5	56,5	14,0	16,0
1212636	-0406	1/4"	9/16-18	9/16-18	23,5	66,0	14,0	19,0
1212637	-0606	3/8"	11/16-16	9/16-18	25,0	66,0	17,0	19,0
1212638	-0608	3/8"	11/16-16	3/4-16	26,5	75,0	19,0	24,0
1212639	-0808	1/2"	13/16-16	3/4-16	28,0	75,0	19,0	24,0
1212640	-0810	1/2"	13/16-16	7/8-14	31,0	89,0	22,0	27,0
1212641	-1010	5/8"	1-14	7/8-14	33,5	89,0	27,0	27,0
1212642	-1012	5/8"	1-14	1 1/16-12	36,0	101,0	27,0	32,0
1212643	-1212	3/4"	1 3/16-12	1 1/16-12	37,5	101,0	30,0	32,0
1212644	-1216	3/4"	1 3/16-12	1 5/16-12	41,5	114,0	36,0	41,0
1212645	-1616	1"	1 7/16-12	1 5/16-12	42,0	114,0	36,0	41,0
1212646	-1620	1"	1 7/16-12	1 5/8-12	45,0	126,0	41,0	50,0
1212647	-2020	1 1/4"	1 11/16-12	1 5/8-12	45,0	126,0	41,0	50,0
1212648	-2024	1 1/4"	1 11/16-12	1 7/8-12	49,0	139,0	48,0	55,0
1212649	-2424	1 1/2"	2-12	1 7/8-12	49,0	139,0	48,0	55,0

// R1A2411305

Straight connector ORFS Female - SAE UNF/UN Male with
O-Ring

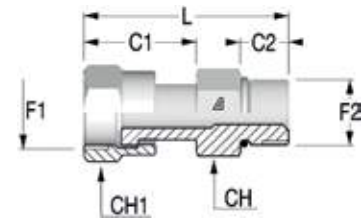

Item Code	Head 1 / Head 2	OD1 in	F1	F2	C1	C2	CH	CH1	L
	Dash/mm				mm	mm	mm	mm	mm
1212508	-0404	1/4"	9/16-18	7/16-20	24,2	11,0	17,0	19,0	45,0
1212509	-0606	3/8"	11/16-16	9/16-18	27,5	12,0	19,0	22,0	50,0
1212510	-0808	1/2"	13/16-16	3/4-16	33,0	14,0	22,0	24,0	60,0
1208302	-1008	5/8"	1-14	3/4-16	33,0	14,0	24,0	30,0	52,0
1212511	-1010	5/8"	1-14	7/8-14	37,5	16,0	27,0	30,0	67,0
1212512	-1212	3/4"	1 3/16-12	1 1/16-12	41,5	18,5	32,0	36,0	73,5
1212513	-1616	1"	1 7/16-12	1 5/16-12	43,8	18,5	41,0	41,0	82,0
1212514	-2020	1 1/4"	1 11/16-12	1 5/8-12	43,8	18,5	50,0	50,0	82,0
1212515	-2424	1 1/2"	2-12	1 7/8-12	47,5	18,5	55,0	60,0	81,0

// R1A245T305

**Branch Tee adjustable elbow connector ORFS Male - SAE UNF/
UN Male with O-Ring**

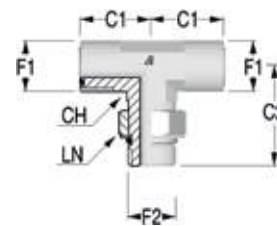

Item Code	Head 1 / Head 2	OD1	F1	F2	C1	C2	CH	LN
	Dash				in	mm		
1210720	-0404	1/4"	9/16-18	9/16-18	21,5	32,5	14,0	16,0
1210780	-0606	3/8"	11/16-16	11/16-16	25,0	37,0	17,0	19,0
1210781	-0808	1/2"	13/16-16	13/16-16	28,0	40,5	19,0	24,0
1210782	-1010	5/8"	1-14	1-14	33,5	50,0	27,0	27,0
1210783	-1212	3/4"	1 3/16-12	1 3/16-12	37,5	55,0	30,0	32,0
1211521	-1616	1"	1 7/16-12	1 7/16-12	42,0	60,0	36,0	41,0
1211522	-2020	1 1/4"	1 11/16-12	1 11/16-12	45,0	62,0	41,0	50,0
1211523	-2424	1 1/2"	2-12	2-12	49,0	66,0	48,0	55,0

// R1A245L305

**Run Tee adjustable elbow connector ORFS Male - SAE UNF/UN
Male with O-Ring**

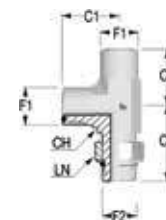

Item Code	Head 1 / Head 2	OD1	F1	F2	C1	C2	CH	LN
	Dash				in	mm		
1210798	-0404	1/4"	9/16-18	7/16-20	21,5	32,5	14,0	16,0
1210799	-0606	3/8"	11/16-16	9/16-18	25,0	37,0	17,0	19,0
1210818	-0808	1/2"	13/16-16	3/4-16	28,0	40,5	19,0	24,0
1210819	-1010	5/8"	1-14	7/8-14	33,5	50,0	27,0	27,0
1211509	-1212	3/4"	1 3/16-12	1 1/16-12	37,5	55,0	30,0	32,0
1211510	-1616	1"	1 7/16-12	1 5/16-12	42,0	60,0	36,0	41,0
1211511	-2020	1 1/4"	1 11/16-12	1 5/8-12	45,0	62,0	41,0	50,0
1211512	-2424	1 1/2"	2-12	1 7/8-12	49,0	66,0	48,0	55,0

Dimensions shown may be changed without prior notice

// FLANGES

// R1A245133W

Straight flange SAE J518 code 61 - ORFS Male - Low pressure

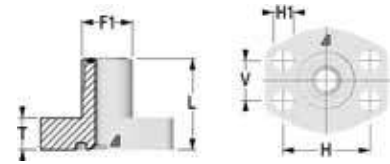

Item Code	Head / Flange	OD1 in	F1	Flange Size	L	T	H	V	H1
	Dash				mm	mm	mm	mm	mm
1212569	-0608	3/8"	11/16-16	1/2	37,0	14,0	38,1	17,5	9,0
1212570	-0808	1/2"	13/16-16	1/2	39,0	14,0	38,1	17,5	9,0
1212571	-1008	5/8"	1-14	1/2	40,0	14,0	38,1	17,5	9,0
1212572	-1012	5/8"	1-14	3/4	44,0	15,0	47,6	22,2	11,0
1212573	-1212	3/4"	1 3/16-12	3/4	45,0	15,0	47,6	22,2	11,0
1212574	-1216	3/4"	1 3/16-12	1	48,0	17,0	52,4	26,2	11,0
1212575	-1616	1"	1 7/16-12	1	49,0	17,0	52,4	26,2	11,0
1212576	-1620	1"	1 7/16-12	1 1/4	55,0	21,0	58,7	30,2	11,5
1212577	-2020	1"1/4	1 11/16-12	1 1/4	55,0	21,0	58,7	30,2	11,5
1212578	-2024	1"1/4	1 11/16-12	1 1/2	59,0	24,0	69,9	35,7	13,5
1212579	-2424	1"1/2	2-12	1 1/2	61,0	24,0	69,9	35,7	13,5

// R1A245136W

Straight flange SAE J518 code 62 - ORFS Male - High pressure

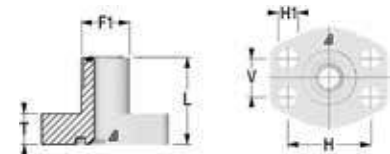

Item Code	Head / Flange	OD1 in	F1	Flange Size	L	T	H	V	H1
	Dash				mm	mm	mm	mm	mm
1212580	-0608	3/8"	11/16-16	1/2	37,0	15,0	40,5	18,2	9,0
1212581	-0808	1/2"	13/16-16	1/2	39,0	15,0	40,5	18,2	9,0
1212582	-1008	5/8"	1-14	1/2	40,0	15,0	40,5	18,2	9,0
1212583	-1012	5/8"	1-14	3/4	44,0	17,0	50,8	23,8	11,0
1212584	-1212	3/4"	1 3/16-12	3/4	45,0	17,0	50,8	23,8	11,0
1212585	-1216	3/4"	1 3/16-12	1	48,0	21,0	57,2	27,8	13,0
1212586	-1616	1"	1 7/16-12	1	49,0	21,0	57,2	27,8	13,0
1212587	-1620	1"	1 7/16-12	1 1/4	55,0	24,0	66,7	31,8	15,0
1212588	-2020	1"1/4	1 11/16-12	1 1/4	55,0	24,0	66,7	31,8	15,0
1212589	-2024	1"1/4	1 11/16-12	1 1/2	59,0	27,0	79,4	36,5	17,0
1212590	-2424	1"1/2	2-12	1 1/2	61,0	27,0	79,4	36,5	17,0

// R1A245933W

90° flange SAE J518 code 61 - ORFS Male - Low pressure

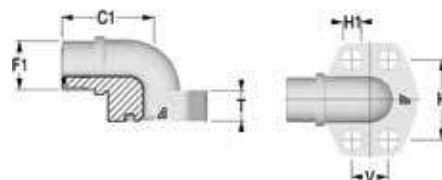

Item Code	Head / Flange	OD1 in	F1	Flange size	C1	T	H	V	H1
	Dash				mm	mm	mm	mm	mm
1212650	-0608	3/8"	11/16-16	1/2	37,0	17,0	38,1	17,5	9,0
1212651	-0808	1/2"	13/16-16	1/2	39,0	17,0	38,1	17,5	9,0
1212652	-1008	5/8"	1-14	1/2	40,0	20,0	38,1	17,5	9,0
1212653	-1012	5/8"	1-14	3/4	44,0	20,0	47,6	22,2	11,0
1212654	-1212	3/4"	1 3/16-12	3/4	45,0	25,0	47,6	22,2	11,0
1212655	-1216	3/4"	1 3/16-12	1	48,0	25,0	52,4	26,2	11,0
1212656	-1616	1"	1 7/16-12	1	49,0	31,0	52,4	26,2	11,0
1212657	-1620	1"	1 7/16-12	1 1/4	55,0	31,0	58,7	30,2	11,5
1212658	-2020	1 1/4"	1 11/16-12	1 1/4	55,0	31,0	58,7	30,2	11,5
1212659	-2024	1 1/4"	1 11/16-12	1 1/2	59,0	31,0	69,9	35,7	13,5
1212660	-2424	1 1/2"	2-12	1 1/2	61,0	37,0	69,9	35,7	13,5

// R1A245936W

90° flange SAE J518 code 62 - ORFS Male - High pressure

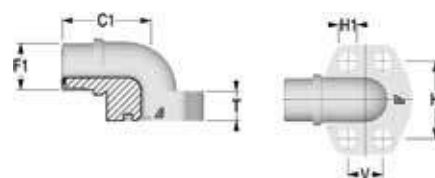

Item Code	Head / Flange	OD1 in	F1	Flange size	C1	T	H	V	H1
	Dash				mm	mm	mm	mm	mm
1212670	-0608	3/8"	11/16-16	1/2	37,0	17,0	40,5	18,2	9,0
1212671	-0808	1/2"	13/16-16	1/2	39,0	17,0	40,5	18,2	9,0
1212672	-1008	5/8"	1-14	1/2	40,0	20,0	40,5	18,2	9,0
1212673	-1012	5/8"	1-14	3/4	44,0	20,0	50,8	23,8	11,0
1212674	-1212	3/4"	1 3/16-12	3/4	45,0	25,0	50,8	23,8	11,0
1212675	-1216	3/4"	1 3/16-12	1	48,0	25,0	57,2	27,8	13,0
1212676	-1616	1"	1 7/16-12	1	49,0	31,0	57,2	27,8	13,0
1212677	-1620	1"	1 7/16-12	1 1/4	55,0	31,0	66,7	31,8	15,0
1212678	-2020	1 1/4"	1 11/16-12	1 1/4	55,0	31,0	66,7	31,8	15,0
1212679	-2024	1 1/4"	1 11/16-12	1 1/2	59,0	37,0	79,4	36,5	17,0
1212680	-2424	1 1/2"	2-12	1 1/2	61,0	37,0	79,4	36,5	17,0

Dimensions shown may be changed without prior notice

// R1A2459334

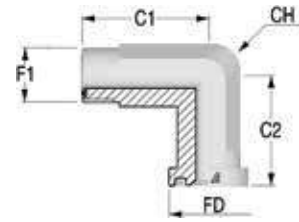
90° adjustable flange SAE J518 code 61 - ORFS Male - Low pressure

Item Code	Head / Flange	OD1	F1	Flange size	C1	C2	FD	CH
	Dash	in			mm	mm		
1212662	-0808	1/2"	13/16-16	1/2	48,0	42,0	30,2	22,0
1212663	-1008	5/8"	1-14	1/2	50,0	44,0	30,2	22,0
1212664	-1212	3/4"	1 3/16-12	3/4	64,0	53,0	38,1	27,0
1212665	-1616	1"	1 7/16-12	1	65,0	60,0	44,4	34,0
1212666	-1620	1"	1 7/16-12	1 1/4	64,0	55,0	50,8	42,0
1212667	-2020	1"1/4	1 11/16-12	1 1/4	64,0	55,0	50,8	42,0
1212668	-2024	1"1/4	1 11/16-12	1 1/2	78,0	66,0	60,3	50,0
1212669	-2424	1"1/2	2-12	1 1/2	78,0	66,0	60,3	50,0

// R1A2459364

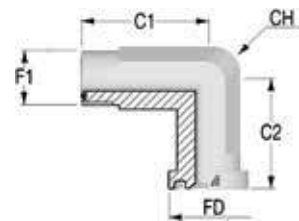
90° adjustable flange SAE J518 code 62 - ORFS Male - High pressure

Item Code	Head / Flange	OD1	F1	Flange size	C1	C2	FD	CH
	Dash	in			mm	mm		
1212681	-0608	3/8"	11/16-16	1/2	50,0	44,0	31,8	22,0
1212682	-0808	1/2"	13/16-16	1/2	43,0	49,0	31,8	22,0
1212683	-1008	5/8"	1-14	1/2	50,0	44,0	31,8	22,0
1212684	-1012	5/8"	1-14	3/4	64,0	53,0	41,3	27,0
1212685	-1212	3/4"	1 3/16-12	3/4	64,0	53,0	41,3	27,0
1212686	-1216	3/4"	1 3/16-12	1	62,0	60,0	47,6	34,0
1212687	-1616	1"	1 7/16-12	1	62,0	60,0	47,6	34,0
1212688	-1620	1"	1 7/16-12	1 1/4	72,0	70,0	54,0	42,0
1212689	-2020	1"1/4	1 11/16-12	1 1/4	72,0	70,0	54,0	42,0
1212690	-2024	1"1/4	1 11/16-12	1 1/2	84,0	80,0	63,5	50,0
1212691	-2424	1"1/2	2-12	1 1/2	84,0	80,0	63,5	50,0

// ACCESSORIES

// HX0D2403

Nut ORFS

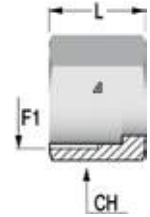

Item Code	Head	OD1 mm	F1	CH	L mm
	Dash			mm	
1223385	-0400	6	9/16-18	17,0	14,50
1221423	-0600	8	11/16-16	22,0	17,00
1209980	-0800	12	13/16-16	24,0	21,00
1209992	-1000	14	1-14	30,0	23,50
1210042	-1200	18	1 3/16-12	36,0	26,00
1217528	-1600	22	1 7/16-12	41,0	28,00
1217529	-2000	28	1 11/16-12	50,0	28,00
1217530	-2400	35	2-12	57,0	28,00

Dimensions shown may be changed without prior notice

// PLUG

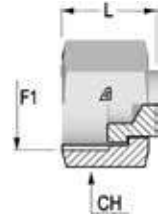
// R1A2431000
Cap ORFS Female

Item Code	Head	OD1	F1	CH	L
	Dash	in		mm	mm
1207932	-0400	1/4"	9/16-18	17,0	17,0
1207711	-0600	3/8"	11/16-16	22,0	20,0
1207933	-0800	1/2"	13/16-16	24,0	23,0
1208261	-1000	5/8"	1-14	30,0	27,0
1208260	-1200	3/4"	1 3/16-12	36,0	30,0
1208259	-1600	1"	1 7/16-12	41,0	31,0
1208258	-2000	1 1/4"	1 11/16-12	50,0	31,0
1210844	-2400	1 1/2"	2-12	57,0	31,0

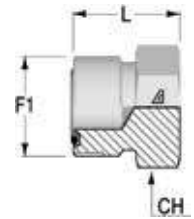
// R1A2451000
Plug ORFS Male

Item Code	Head	OD1	F1	CH	L
	Dash	in		mm	mm
1207934	-0400	1/4"	9/16-18	17,0	16,5
1207772	-0600	3/8"	11/16-16	19,0	19,0
1207935	-0800	1/2"	13/16-16	22,0	22,0
1208215	-1000	5/8"	1-14	27,0	26,0
1208216	-1200	3/4"	1 3/16-12	32,0	27,5
1208217	-1600	1"	1 7/16-12	41,0	28,0
1208218	-2000	1 1/4"	1 11/16-12	46,0	28,0
1210824	-2400	1 1/2"	2-12	55,0	28,0



// BSP ADAPTERS

// MALE UNION.....	263	// BSPP	270
// MALE / FEMALE UNION	265	// FLANGES	273
// FEMALE UNION	267	// PLUG	276
// BULKHEAD.....	268		

Dimensions shown may be changed without prior notice

// MALE UNION

// R1A05M105M

Straight union BSP 60° Male

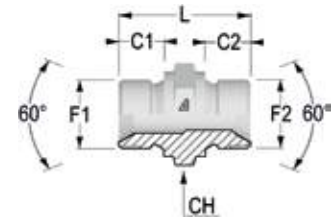

Item Code	Head 1 / Head 2	OD1 in	F1	F2	C1	C2	CH mm	L mm
	Dash				mm	mm		
1203778	-0202	1/8"	1/8-28	1/8-28	8,0	8,0	14,0	25,0
1207670	-0204	1/8"	1/8-28	1/4-19	8,0	11,0	19,0	27,5
1212029	-0206	1/8"	1/8-28	3/8-19	8,0	12,0	22,0	30,0
1212030	-0208	1/8"	1/8-28	1/2-14	8,0	14,0	27,0	33,0
1203775	-0404	1/4"	1/4-19	1/4-19	11,0	11,0	19,0	31,0
1207671	-0406	1/4"	1/4-19	3/8-19	11,0	12,0	22,0	33,5
1207672	-0408	1/4"	1/4-19	1/2-14	11,0	14,0	27,0	36,0
1208335	-0412	1/4"	1/4-19	3/4-14	11,0	16,0	32,0	39,5
1203798	-0606	3/8"	3/8-19	3/8-19	12,0	12,0	22,0	35,0
1207673	-0608	3/8"	3/8-19	1/2-14	12,0	14,0	27,0	37,5
1212031	-0610	3/8"	3/8-19	5/8-14	12,0	16,0	30,0	40,5
1207701	-0612	3/8"	3/8-19	3/4-14	12,0	16,0	32,0	41,0
1212032	-0616	3/8"	3/8-19	1-11	12,0	18,0	41,0	46,0
1203766	-0808	1/2"	1/2-14	1/2-14	14,0	14,0	27,0	40,0
1212033	-0810	1/2"	1/2-14	5/8-14	14,0	16,0	30,0	43,0
1207674	-0812	1/2"	1/2-14	3/4-14	14,0	16,0	32,0	43,5
1212034	-0816	1/2"	1/2-14	1-11	14,0	18,0	41,0	48,0
1212035	-0820	1/2"	1/2-14	1 1/4-11	14,0	20,0	50,0	52,0
1212036	-0824	1/2"	1/2-14	1 1/2-11	14,0	22,0	55,0	56,0
1203803	-1010	5/8"	5/8-14	5/8-14	16,0	16,0	30,0	45,0
1208252	-1012	5/8"	5/8-14	3/4-14	16,0	16,0	32,0	45,5
1205572	-1016	5/8"	5/8-14	1-11	16,0	18,0	41,0	50,0
1212037	-1020	5/8"	5/8-14	1 1/4-11	16,0	20,0	50,0	54,0
1203789	-1212	3/4"	3/4-14	3/4-14	16,0	16,0	32,0	45,5
1207675	-1216	3/4"	3/4-14	1-11	16,0	18,0	41,0	50,0
1208293	-1220	3/4"	3/4-14	1 1/4-11	16,0	20,0	50,0	54,0
1212038	-1224	3/4"	3/4-14	1 1/2-11	16,0	22,0	55,0	58,0
1203747	-1616	1"	1-11	1-11	18,0	18,0	41,0	52,0
1207676	-1620	1"	1-11	1 1/4-11	18,0	20,0	50,0	56,0
1207677	-1624	1"	1-11	1 1/2-11	18,0	22,0	55,0	60,0
1203757	-2020	1 1/4"	1 1/4-11	1 1/4-11	20,0	20,0	50,0	58,0
1208195	-2024	1 1/4"	1 1/4-11	1 1/2-11	20,0	22,0	55,0	62,0
1212040	-2032	1 1/4"	1 1/4-11	2-11	20,0	24,0	70,0	64,5
1203751	-2424	1 1/2"	1 1/2-11	1 1/2-11	22,0	22,0	55,0	64,0
1205940	-2432	1 1/2"	1 1/2-11	2-11	22,0	24,0	70,0	66,5
1203780	-3232	2"	2-11	2-11	24,0	24,0	70,0	69,0

// R1A05M905M
90° union BSP 60° Male

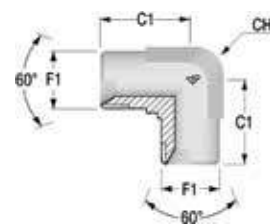

Item Code	Head 1 / Head 2	OD1	F1	C1	CH
	Dash	in		mm	mm
1207905	-0202	1/8"	1/8-28	20,0	12,0
1207505	-0404	1/4"	1/4-19	26,0	14,0
1206438	-0606	3/8"	3/8-19	30,0	17,0
1207542	-0808	1/2"	1/2-14	35,0	22,0
1212187	-1010	5/8"	5/8-14	38,0	22,0
1203905	-1212	3/4"	3/4-14	42,0	27,0
1208198	-1616	1"	1-11	45,5	33,0
1208199	-2020	1 1/4"	1 1/4-11	52,0	41,0
1210968	-2424	1 1/2"	1 1/2-11	60,0	48,0

// R1A05MT05M
Branch Tee union BSP 60° Male

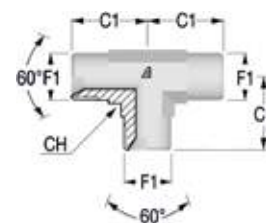

Item Code	Head 1 / Head 2	OD1	F1	C1	CH
	Dash	in		mm	mm
1211959	-0202	1/8"	1/8-28	20,0	12,0
1203955	-0404	1/4"	1/4-19	26,0	14,0
1203956	-0606	3/8"	3/8-19	30,0	17,0
1206940	-0808	1/2"	1/2-14	35,0	22,0
1211960	-1010	5/8"	5/8-14	38,0	22,0
1207236	-1212	3/4"	3/4-14	42,0	27,0
1206450	-1616	1"	1-11	47,0	33,0
1208144	-2020	1 1/4"	1 1/4-11	52,0	41,0
1208145	-2424	1 1/2"	1 1/2-11	60,0	48,0

// R1A05MX05M
Cross union BSP 60° Male

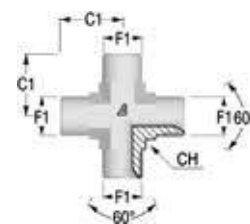

Item Code	Head 1 / Head 2	OD1	F1	C1	CH
	Dash	in		mm	mm
1212021	-0202	1/8"	1/8-28	20,0	12,0
1212022	-0404	1/4"	1/4-19	26,0	14,0
1212023	-0606	3/8"	3/8-19	30,0	17,0
1206941	-0808	1/2"	1/2-14	35,0	22,0
1212024	-1010	5/8"	5/8-14	38,0	22,0
1212025	-1212	3/4"	3/4-14	42,0	27,0
1212026	-1616	1"	1-11	47,0	33,0
1212027	-2020	1 1/4"	1 1/4-11	52,0	41,0
1212028	-2424	1 1/2"	1 1/2-11	60,0	48,0

Dimensions shown may be changed without prior notice

// MALE / FEMALE UNION

// R1A05M1051

Straight union BSP 60° Male - Female

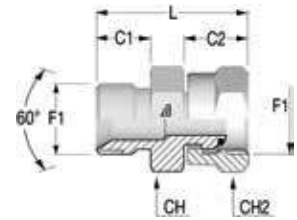

Item Code	Head 1 / Head 2	OD1	F1	C1	C2	CH	CH2	L
	Dash							
1216217	-0202	1/8"	1/8-28	8,0	13,5	14,0	14,0	29,5
1207697	-0404	1/4"	1/4-19	11,0	15,5	19,0	19,0	30,0
1207698	-0606	3/8"	3/8-19	13,0	17,7	22,0	22,0	33,5
1207699	-0808	1/2"	1/2-14	16,0	19,0	27,0	27,0	40,0
1207700	-1212	3/4"	3/4-14	17,0	22,0	32,0	32,0	42,0
1207686	-1616	1"	1-11	19,0	25,5	41,0	38,0	48,0
1207783	-2020	1"1/4	1 1/4-11	20,0	31,1	50,0	50,0	54,0
1207784	-2424	1"1/2	1 1/2-11	22,0	35,0	55,0	55,0	58,0

// R1A05M4051

45° union BSP 60° Male - Female

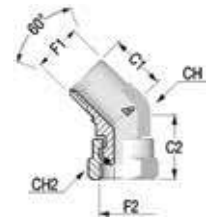

Item Code	Head 1 / Head 2	OD1	F1	C1	C2	CH	CH2
	Dash						
1212126	-0202	1/8"	1/8-28	16,0	21,0	12,0	14,0
1212145	-0404	1/4"	1/4-19	21,0	25,5	14,0	19,0
1212146	-0606	3/8"	3/8-19	24,0	31,2	17,0	22,0
1207907	-0808	1/2"	1/2-14	27,0	35,5	22,0	27,0
1207786	-1212	3/4"	3/4-14	32,0	39,0	27,0	32,0
1210963	-1616	1"	1-11	35,0	42,5	33,0	38,0
1212148	-2020	1"1/4	1 1/4-11	37,0	44,1	41,0	50,0
1212149	-2424	1"1/2	1 1/2-11	46,0	59,2	48,0	55,0

// R1A05M9051

90° union BSP 60° Male - Female

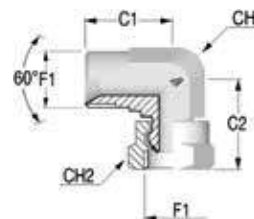

Item Code	Head 1 / Head 2	OD1 in	F1	C1	C2	CH mm	CH2 mm
	Dash			mm	mm		
1218490	-0202	1/8"	1/8-28	22,0	27,0	12,0	14,0
1207702	-0404	1/4"	1/4-19	26,0	30,5	14,0	19,0
1207703	-0606	3/8"	3/8-19	30,0	36,2	17,0	22,0
1207704	-0808	1/2"	1/2-14	35,0	41,5	22,0	27,0
1212219	-1010	5/8"	5/8-14	38,0	47,7	22,0	27,0
1207946	-1212	3/4"	3/4-14	42,0	51,0	27,0	32,0
1207947	-1616	1"	1-11	47,0	54,5	33,0	38,0
1207948	-2020	1 1/4"	1 1/4-11	52,0	59,1	41,0	50,0
1208137	-2424	1 1/2"	1 1/2-11	60,0	73,2	48,0	55,0

// R1A05MT051

Branch Tee union BSP 60° Male - Female

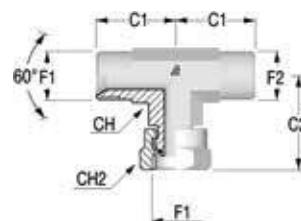

Item Code	Head 1 / Head 2	OD1 in	F1	C1	C2	CH mm	CH2 mm
	Dash			mm	mm		
1211970	-0202	1/8"	1/8-28	22,0	27,0	12,0	14,0
1207705	-0404	1/4"	1/4-19	26,0	30,5	14,0	19,0
1207706	-0606	3/8"	3/8-19	30,0	36,2	17,0	22,0
1207707	-0808	1/2"	1/2-14	35,0	41,5	22,0	27,0
1211982	-1010	5/8"	5/8-14	38,0	47,7	22,0	27,0
1207708	-1212	3/4"	3/4-14	42,0	51,0	27,0	32,0
1207709	-1616	1"	1-11	47,0	54,5	33,0	38,0
1210950	-2020	1 1/4"	1 1/4-11	52,0	59,1	41,0	50,0
1211983	-2424	1 1/2"	1 1/2-11	60,0	73,2	48,0	55,0

// R1A05ML051

Run Tee union BSP 60° Male - Female

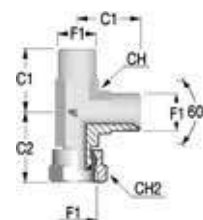

Item Code	Head 1 / Head 2	OD1 in	F1	C1	C2	CH mm	CH2 mm
	Dash			mm	mm		
1211908	-0202	1/8"	1/8-28	22,0	27,0	12,0	14,0
1207787	-0404	1/4"	1/4-19	26,0	30,5	14,0	19,0
1207788	-0606	3/8"	3/8-19	30,0	36,2	17,0	22,0
1207789	-0808	1/2"	1/2-14	35,0	41,5	22,0	27,0
1207790	-1212	3/4"	3/4-14	42,0	51,0	27,0	32,0
1207791	-1616	1"	1-11	47,0	54,5	33,0	38,0
1210946	-2020	1 1/4"	1 1/4-11	52,0	59,1	41,0	50,0
1211921	-2424	1 1/2"	1 1/2-11	60,0	73,2	48,0	55,0

Dimensions shown may be changed without prior notice

// FEMALE UNION

// R1A0511051

Straight union BSP 60° Female

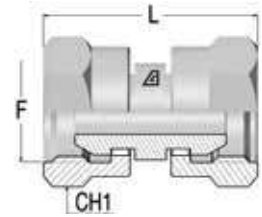

Item Code	Head 1 / Head 2	OD1	F1	F2	CH1	CH2	L
	Dash	in			mm	mm	
1205935	-0404	1/4"	1/4-19	1/4-19	19,0	19,0	30,0
1205934	-0606	3/8"	3/8-19	3/8-19	22,0	22,0	39,0
1205936	-0808	1/2"	1/2-14	1/2-14	27,0	27,0	44,0
1207901	-1212	3/4"	3/4-14	3/4-14	32,0	32,0	50,0
1203738	-1616	1"	1-11	1-11	38,0	38,0	56,0

// R1A0519051

90° union BSP 60° Female

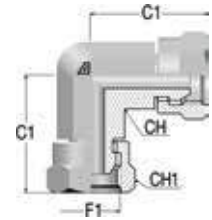

Item Code	Head 1 / Head 2	OD1	F1	C1	CH	CH1
	Dash	in		mm	mm	mm
1224079	-0404	1/4"	1/4-19	30,0	14,0	19,0
1224080	-0606	3/8"	3/8-19	39,0	17,0	22,0
1208320	-0808	1/2"	1/2-14	44,0	22,0	27,0
1224081	-1212	3/4"	3/4-14	50,0	27,0	32,0
1224082	-1616	1"	1-11	56,0	33,0	38,0

// R1A051T051

Branch Tee union BSP 60° Female

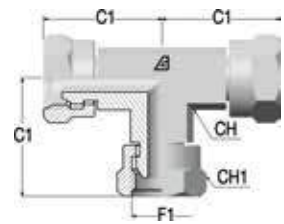

Item Code	Head 1 / Head 2	OD1	F1	C1	CH	CH1
	Dash	in		mm	mm	mm
1218501	-0404	1/4"	1/4-19	30,0	14,0	19,0
1218502	-0606	3/8"	3/8-19	39,0	17,0	22,0
1218503	-0808	1/2"	1/2-14	44,0	22,0	27,0
1206665	-1212	3/4"	3/4-14	50,0	27,0	32,0
1218505	-1616	1"	1-11	56,0	33,0	38,0

// BULKHEAD

// R1A05M105T

Straight union BSP 60° Bulkhead

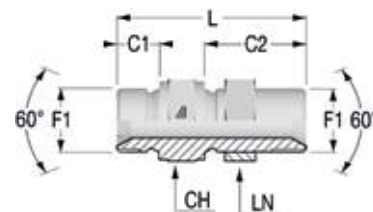

Item Code	Head 1 / Head 2	OD1 in	F1	C1 mm	C2 mm	CH mm	LN mm	L mm
	Dash							
1212042	-0202	1/8"	1/8-28	9,5	25,0	14,0	14,0	40,5
1207678	-0404	1/4"	1/4-19	13,0	29,0	19,0	19,0	47,0
1207679	-0606	3/8"	3/8-19	14,5	31,0	22,0	22,0	51,5
1207680	-0808	1/2"	1/2-14	17,0	34,0	27,0	27,0	57,0
1207681	-1010	5/8"	5/8-14	19,0	37,0	30,0	32,0	63,0
1207682	-1212	3/4"	3/4-14	19,0	37,0	32,0	32,0	63,5
1207683	-1616	1"	1-11	21,0	41,0	41,0	41,0	72,0
1207684	-2020	1 1/4"	1 1/4-11	23,0	45,0	50,0	50,0	80,0
1210955	-2424	1 1/2"	1 1/2-11	25,0	49,0	55,0	55,0	88,0

// R1A05M905T

90° elbow connector BSP 60° Bulkhead

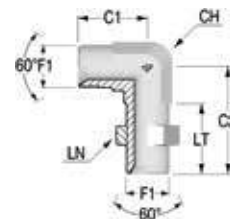

Item Code	Head 1 / Head 2	OD1 in	F1	C1 mm	C2 mm	CH mm	LN mm	LT mm
	Dash							
1212188	-0202	1/8"	1/8-28	20,0	37,0	12,0	14,0	25,0
1210969	-0404	1/4"	1/4-19	26,0	44,0	14,0	19,0	29,0
1210970	-0606	3/8"	3/8-19	30,0	49,0	17,0	22,0	31,0
1210971	-0808	1/2"	1/2-14	35,0	55,0	22,0	27,0	34,0
1212189	-1010	5/8"	5/8-14	38,0	59,0	22,0	32,0	37,0
1210972	-1212	3/4"	3/4-14	42,0	63,0	27,0	32,0	37,0
1210973	-1616	1"	1-11	47,0	69,0	33,0	41,0	41,0
1210974	-2020	1 1/4"	1 1/4-11	52,0	77,0	41,0	50,0	45,0
1210975	-2424	1 1/2"	1 1/2-11	60,0	87,0	48,0	55,0	49,0

Dimensions shown may be changed without prior notice

// R1A05MT05T

Branch Tee union BSP 60° Bulkhead

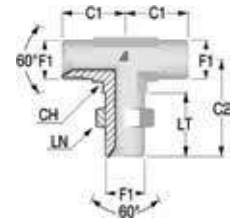

Item Code	Head 1 / Head 2	OD1	F1	C1	C2	CH	LN	LT
	Dash							
1211961	-0202	1/8"	1/8-28	20,0	37,0	12,0	14,0	25,0
1211962	-0404	1/4"	1/4-19	26,0	44,0	14,0	19,0	29,0
1211963	-0606	3/8"	3/8-19	30,0	49,0	17,0	22,0	31,0
1211964	-0808	1/2"	1/2-14	35,0	55,0	22,0	27,0	34,0
1211965	-1010	5/8"	5/8-14	38,0	59,0	22,0	32,0	37,0
1211966	-1212	3/4"	3/4-14	42,0	63,0	27,0	32,0	37,0
1211967	-1616	1"	1-11	47,0	69,0	33,0	41,0	41,0
1211968	-2020	1 1/4"	1 1/4-11	52,0	77,0	41,0	50,0	45,0
1211969	-2424	1 1/2"	1 1/2-11	60,0	87,0	48,0	55,0	49,0

// R1A05ML05T

Run Tee union BSP 60° Bulkhead

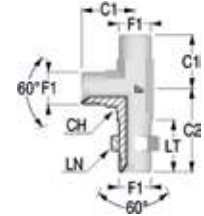

Item Code	Head 1 / Head 2	OD1	F1	C1	C2	CH	LN	LT
	Dash							
1211899	-0202	1/8"	1/8-28	20,0	37,0	12,0	14,0	25,0
1211900	-0404	1/4"	1/4-19	26,0	44,0	14,0	19,0	29,0
1211901	-0606	3/8"	3/8-19	30,0	49,0	17,0	22,0	31,0
1211902	-0808	1/2"	1/2-14	35,0	55,0	22,0	27,0	34,0
1211903	-1010	5/8"	5/8-14	38,0	59,0	22,0	32,0	37,0
1211904	-1212	3/4"	3/4-14	42,0	63,0	27,0	32,0	37,0
1211905	-1616	1"	1-11	47,0	69,0	33,0	41,0	41,0
1211906	-2020	1 1/4"	1 1/4-11	52,0	77,0	41,0	50,0	45,0
1211907	-2424	1 1/2"	1 1/2-11	60,0	87,0	48,0	55,0	49,0

// BSPP

// R1A05M106N

Straight connector BSP 60° Male - BSPP cylindric Male with O-Ring and retaining ring

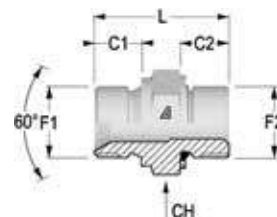

Item Code	Head 1 / Head 2	OD1 in	F1	F2	C1 mm	C2 mm	CH mm	L mm
	Dash							
1212043	-0202	1/8"	1/8-28	1/8-28	9,5	7,5	14,0	21,5
1212044	-0204	1/8"	1/8-28	1/4-19	9,5	11,0	19,0	28,0
1212045	-0404	1/4"	1/4-19	1/4-19	13,0	11,0	19,0	28,0
1212046	-0406	1/4"	1/4-19	3/8-19	13,0	11,0	22,0	31,0
1212047	-0604	3/8"	3/8-19	1/4-19	14,5	11,0	22,0	33,0
1212048	-0606	3/8"	3/8-19	3/8-19	14,5	11,0	22,0	34,0
1212049	-0608	3/8"	3/8-19	1/2-14	14,5	14,5	27,0	38,0
1212050	-0806	1/2"	1/2-14	3/8-19	17,0	11,0	27,0	35,0
1212051	-0808	1/2"	1/2-14	1/2-14	17,0	14,5	27,0	40,0
1212052	-0812	1/2"	1/2-14	3/4-14	17,0	14,5	32,0	40,0
1212053	-1008	5/8"	5/8-14	1/2-14	19,0	14,5	27,0	38,5
1236668	-1208	3/4"	3/4-14	1/2-14	19,0	14,5	32,0	44,0
1212055	-1212	3/4"	3/4-14	3/4-14	19,0	14,5	32,0	46,0
1212056	-1216	3/4"	3/4-14	1-11	19,0	18,5	41,0	52,0
1212057	-1612	1"	1-11	3/4-14	21,0	14,5	41,0	49,0
1212058	-1616	1"	1-11	1-11	21,0	18,5	41,0	55,0
1212059	-1620	1"	1-11	1 1/4-11	21,0	18,5	50,0	60,0
1212060	-2020	1"1/4	1 1/4-11	1 1/4-11	23,0	18,5	50,0	62,5
1212061	-2424	1"1/2	1 1/2-11	1 1/2-11	25,0	18,5	55,0	63,0

// R1A05M406N

45° adjustable elbow connector BSP 60° Male - BSPP cylindric Male with O-Ring and retaining ring

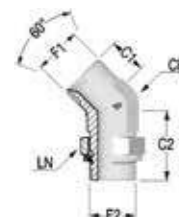

Item Code	Head 1 / Head 2	OD1 in	F1	F2	C1 mm	C2 mm	CH mm	LN mm
	Dash							
1212127	-0202	1/8"	1/8-28	1/8-28	22,0	27,0	12,0	14,0
1212128	-0204	1/8"	1/8-28	1/4-19	24,0	31,5	14,0	19,0
1210962	-0404	1/4"	1/4-19	1/4-19	27,0	31,5	14,0	19,0
1212129	-0406	1/4"	1/4-19	3/8-19	28,0	37,0	17,0	22,0
1212130	-0604	3/8"	3/8-19	1/4-19	29,0	35,0	17,0	19,0
1212131	-0606	3/8"	3/8-19	3/8-19	29,0	37,0	17,0	22,0
1212132	-0608	3/8"	3/8-19	1/2-14	32,0	43,0	19,0	27,0
1212133	-0806	1/2"	1/2-14	3/8-19	34,0	40,0	19,0	22,0
1212134	-0808	1/2"	1/2-14	1/2-14	34,0	43,0	22,0	27,0
1212135	-0810	1/2"	1/2-14	5/8-14	39,0	50,0	27,0	32,0
1212136	-1008	5/8"	5/8-14	1/2-14	37,0	43,0	22,0	27,0
1212137	-1208	3/4"	3/4-14	1/2-14	41,0	46,0	27,0	27,0
1212138	-1212	3/4"	3/4-14	3/4-14	41,0	50,0	27,0	32,0
1212139	-1216	3/4"	3/4-14	1-11	43,0	53,0	33,0	41,0
1212140	-1612	1"	1-11	3/4-14	46,0	52,0	33,0	32,0
1212141	-1616	1"	1-11	1-11	46,0	53,0	33,0	41,0
1212142	-1620	1"	1-11	1 1/4-11	50,0	58,0	41,0	50,0
1212143	-2020	1"1/4	1 1/4-11	1 1/4-11	51,0	58,0	41,0	50,0
1212144	-2424	1"1/2	1 1/2-11	1 1/2-11	59,0	67,0	48,0	55,0

Dimensions shown may be changed without prior notice

// R1A05M906N

90° adjustable elbow connector BSP 60° Male - BSPP cylindric Male with O-Ring and retaining ring

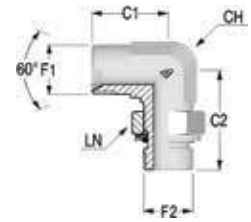

Item Code	Head 1 / Head 2	OD1	F1	F2	C1	C2	CH	LN
	Dash	in						
1212191	-0202	1/8"	1/8-28	1/8-28	22,0	27,0	12,0	14,0
1212192	-0204	1/8"	1/8-28	1/4-19	24,0	31,5	14,0	19,0
1208135	-0404	1/4"	1/4-19	1/4-19	27,0	31,5	14,0	19,0
1212193	-0406	1/4"	1/4-19	3/8-19	28,0	37,0	17,0	22,0
1212194	-0604	3/8"	3/8-19	1/4-19	29,0	35,0	17,0	19,0
1207949	-0606	3/8"	3/8-19	3/8-19	29,0	37,0	17,0	22,0
1212195	-0608	3/8"	3/8-19	1/2-14	32,0	43,0	19,0	27,0
1212196	-0806	1/2"	1/2-14	3/8-19	34,0	40,0	19,0	22,0
1207950	-0808	1/2"	1/2-14	1/2-14	34,0	43,0	22,0	27,0
1212199	-1208	3/4"	3/4-14	1/2-14	41,0	46,0	27,0	27,0
1208136	-1212	3/4"	3/4-14	3/4-14	41,0	50,0	27,0	32,0
1212200	-1216	3/4"	3/4-14	1-11	43,0	53,0	33,0	41,0
1212201	-1612	1"	1-11	3/4-14	46,0	52,0	33,0	32,0
1210745	-1616	1"	1-11	1-11	46,0	53,0	33,0	41,0
1212202	-1620	1"	1-11	1 1/4-11	50,0	58,0	41,0	50,0
1210976	-2020	1 1/4"	1 1/4-11	1 1/4-11	51,0	58,0	41,0	50,0
1210977	-2424	1 1/2"	1 1/2-11	1 1/2-11	59,0	67,0	48,0	55,0

// R1A05MT06N

Branch Tee adjustable elbow connector BSP 60° Male - BSPP cylindric Male with O-Ring and retaining ring

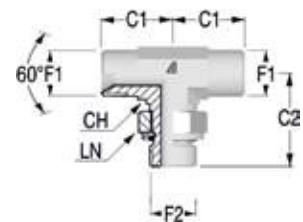

Item Code	Head 1 / Head 2	OD1	F1	F2	C1	C2	CH	LN
	Dash	in						
1211971	-0202	1/8"	1/8-28	1/8-28	22,0	27,0	12,0	14,0
1211972	-0204	1/8"	1/8-28	1/8-28	24,0	31,5	14,0	19,0
1208147	-0404	1/4"	1/4-19	1/4-19	27,0	31,5	14,0	19,0
1211973	-0406	1/4"	1/4-19	1/4-19	28,0	37,0	17,0	22,0
1211974	-0604	3/8"	3/8-19	3/8-19	29,0	35,0	17,0	19,0
1210749	-0606	3/8"	3/8-19	3/8-19	29,0	37,0	17,0	22,0
1211976	-0806	1/2"	1/2-14	1/2-14	34,0	40,0	19,0	22,0
1210713	-0808	1/2"	1/2-14	1/2-14	34,0	43,0	22,0	27,0
1211978	-1008	5/8"	5/8-14	5/8-14	37,0	43,0	22,0	27,0
1211979	-1208	3/4"	3/4-14	3/4-14	41,0	46,0	27,0	27,0
1210750	-1212	3/4"	3/4-14	3/4-14	41,0	50,0	27,0	32,0
1211980	-1216	3/4"	3/4-14	3/4-14	43,0	53,0	33,0	41,0
1211981	-1612	1"	1-11	1-11	46,0	52,0	33,0	32,0
1210947	-1616	1"	1-11	1-11	46,0	53,0	33,0	41,0
1207710	-1620	1"	1-11	1-11	50,0	58,0	41,0	50,0
1210948	-2020	1 1/4"	1 1/4-11	1 1/4-11	51,0	58,0	41,0	50,0
1210949	-2424	1 1/2"	1 1/2-11	1 1/2-11	59,0	67,0	48,0	55,0

// R1A05ML06N

**Run Tee adjustable elbow connector BSP 60° Male - BSPP
cylindric Male with O-Ring and retaining ring**

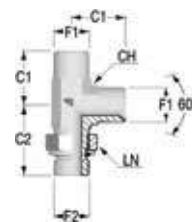

Item Code	Head 1 / Head 2	OD1 in	F1	F2	C1	C2	CH	LN
	Dash				mm	mm	mm	mm
1211909	-0202	1/8"	1/8-28	1/8-28	22,0	27,0	12,0	14,0
1211910	-0204	1/8"	1/8-28	1/4-19	24,0	31,5	14,0	19,0
1210746	-0404	1/4"	1/4-19	1/4-19	27,0	31,5	14,0	19,0
1211911	-0406	1/4"	1/4-19	3/8-19	28,0	37,0	17,0	22,0
1211912	-0604	3/8"	3/8-19	1/4-19	29,0	35,0	17,0	19,0
1208140	-0606	3/8"	3/8-19	3/8-19	29,0	37,0	17,0	22,0
1211913	-0608	3/8"	3/8-19	1/2-14	32,0	43,0	19,0	27,0
1211914	-0806	1/2"	1/2-14	3/8-19	34,0	40,0	19,0	22,0
1208141	-0808	1/2"	1/2-14	1/2-14	34,0	43,0	22,0	27,0
1211915	-0810	1/2"	1/2-14	5/8-14	39,0	50,0	27,0	32,0
1211916	-1008	5/8"	5/8-14	1/2-14	37,0	43,0	22,0	27,0
1211917	-1208	3/4"	3/4-14	1/2-14	41,0	46,0	27,0	27,0
1210715	-1212	3/4"	3/4-14	3/4-14	41,0	50,0	27,0	32,0
1211918	-1216	3/4"	3/4-14	1-11	43,0	53,0	33,0	41,0
1211919	-1612	1"	1-11	3/4-14	46,0	52,0	33,0	32,0
1210942	-1616	1"	1-11	1-11	46,0	53,0	33,0	41,0
1210943	-1620	1"	1-11	1 1/4-11	50,0	58,0	41,0	50,0
1210944	-2020	1"1/4	1 1/4-11	1 1/4-11	51,0	58,0	41,0	50,0
1210945	-2424	1"1/2	1 1/2-11	1 1/2-11	59,0	67,0	48,0	55,0

Dimensions shown may be changed without prior notice

// FLANGES

// R1A05M133W

Straight flange SAE J518 code 61 - BSP - Low pressure

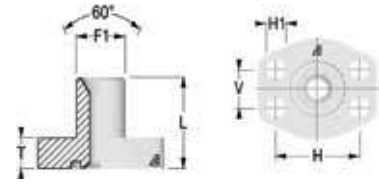

Item Code	Head / Flange	OD1 in	F1	Flange Size	L	T	H	V	H1
	Dash				mm	mm	mm	mm	mm
1212081	-0608	3/8"	3/8-19	1/2	37,0	14,0	38,1	17,5	9,0
1212082	-0808	1/2"	1/2-14	1/2	39,0	14,0	38,1	17,5	9,0
1212083	-0812	1/2"	1/2-14	3/4	42,0	15,0	47,6	22,2	11,0
1212084	-1208	3/4"	3/4-14	1/2	42,0	14,0	38,1	17,5	9,0
1212085	-1212	3/4"	3/4-14	3/4	45,0	15,0	47,6	22,2	11,0
1212086	-1216	3/4"	3/4-14	1	47,0	17,0	52,4	26,2	11,0
1212087	-1612	1"	1-11	3/4	47,0	15,0	47,6	22,2	11,0
1212088	-1616	1"	1-11	1	53,0	21,0	58,7	30,2	11,5
1212089	-2016	1"1/4	1 1/4-11	1	49,0	17,0	52,4	26,2	11,0
1212090	-2020	1"1/4	1 1/4-11	1 1/4	53,0	21,0	58,7	30,2	11,5
1212091	-2024	1"1/4	1 1/4-11	1 1/2	59,0	24,0	69,9	35,7	13,5
1212092	-2420	1"1/2	1 1/2-11	1 1/4	55,0	21,0	58,7	30,2	11,5
1212093	-2424	1"1/2	1 1/2-11	1 1/2	61,0	24,0	69,9	35,7	13,5

// R1A05M136W

Straight flange SAE J518 code 62 - BSP - High pressure

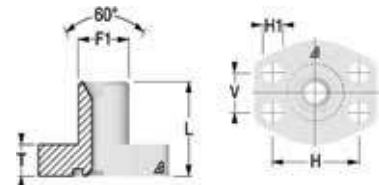

Item Code	Head / Flange	OD1 in	F1	Flange Size	L	T	H	V	H1
	Dash				mm	mm	mm	mm	mm
1212094	-0608	3/8"	3/8-19	1/2	37,0	14,0	38,1	17,5	9,0
1212095	-0808	1/2"	1/2-14	1/2	39,0	14,0	38,1	17,5	9,0
1212096	-0812	1/2"	1/2-14	3/4	42,0	15,0	47,6	22,2	11,0
1212097	-1208	3/4"	3/4-14	1/2	42,0	14,0	38,1	17,5	9,0
1212098	-1212	3/4"	3/4-14	3/4	45,0	15,0	47,6	22,2	11,0
1212099	-1216	3/4"	3/4-14	1	47,0	17,0	52,4	26,2	11,0
1212100	-1612	1"	1-11	3/4	47,0	15,0	47,6	22,2	11,0
1212101	-1616	1"	1-11	1	49,0	17,0	52,4	26,2	11,0
1212102	-1620	1"	1-11	1 1/4	53,0	21,0	58,7	30,2	11,5
1212103	-2016	1"1/4	1 1/4-11	1	49,0	17,0	52,4	26,2	11,0
1212104	-2020	1"1/4	1 1/4-11	1 1/4	53,0	21,0	58,7	30,2	11,5
1212105	-2024	1"1/4	1 1/4-11	1 1/2	59,0	24,0	69,9	35,7	13,5
1212106	-2420	1"1/2	1 1/2-11	1 1/4	55,0	21,0	58,7	30,2	11,5
1212107	-2424	1"1/2	1 1/2-11	1 1/2	61,0	24,0	69,9	35,7	13,5

// R1A05M933W

90° flange SAE J518 code 61 - BSP - Low pressure

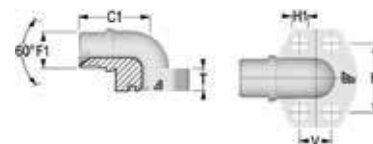

Item Code	Head / Flange	OD1	F1	Flange size	C1	T	H	V	H1
	Dash								
1212252	-0608	3/8"	3/8-19	1/2	37,0	17,0	38,1	17,5	9,0
1212253	-0808	1/2"	1/2-14	1/2	39,0	17,0	38,1	17,5	9,0
1212254	-0812	1/2"	1/2-14	3/4	41,0	20,0	47,6	22,2	11,0
1212255	-1208	3/4"	3/4-14	1/2	40,0	20,0	38,1	17,5	9,0
1212256	-1212	3/4"	3/4-14	3/4	44,0	20,0	47,6	22,2	11,0
1212257	-1216	3/4"	3/4-14	1	47,0	20,0	52,4	26,2	11,0
1212258	-1612	1"	1-11	3/4	45,0	25,0	47,6	22,2	11,0
1212259	-1616	1"	1-11	1	48,0	25,0	52,4	26,2	11,0
1212260	-1620	1"	1-11	1 1/4	54,0	25,0	58,7	30,2	11,5
1212261	-2016	1"1/4	1 1/4-11	1	49,0	31,0	52,4	26,2	11,0
1212262	-2020	1"1/4	1 1/4-11	1 1/4	55,0	31,0	58,7	30,2	11,5
1212263	-2024	1"1/4	1 1/4-11	1 1/2	59,0	31,0	69,9	35,7	13,5
1212264	-2420	1"1/2	1 1/2-11	1 1/4	56,0	37,0	58,7	30,2	11,5
1212265	-2424	1"1/2	1 1/2-11	1 1/2	61,0	37,0	69,9	35,7	13,5

// R1A05M936W

90° flange SAE J518 code 62 - BSP - High pressure

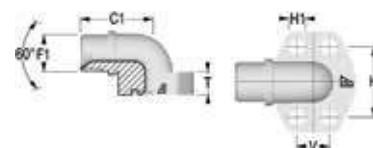

Item Code	Head / Flange	OD1	F1	Flange size	C1	T	H	V	H1
	Dash								
1212278	-0608	3/8"	3/8-19	1/2	37,0	17,0	38,1	17,5	9,0
1212279	-0808	1/2"	1/2-14	1/2	39,0	17,0	38,1	17,5	9,0
1212280	-0812	1/2"	1/2-14	3/4	41,0	20,0	47,6	22,2	11,0
1212281	-1208	3/4"	3/4-14	1/2	40,0	20,0	38,1	17,5	9,0
1212282	-1212	3/4"	3/4-14	3/4	44,0	20,0	47,6	22,2	11,0
1212283	-1216	3/4"	3/4-14	1	47,0	20,0	52,4	26,2	11,0
1212284	-1612	1"	1-11	3/4	45,0	25,0	47,6	22,2	11,0
1212285	-1616	1"	1-11	1	48,0	25,0	52,4	26,2	11,0
1212286	-1620	1"	1-11	1 1/4	54,0	25,0	58,7	30,2	11,5
1212287	-2016	1"1/4	1 1/4-11	1	49,0	31,0	52,4	26,2	11,0
1212288	-2020	1"1/4	1 1/4-11	1 1/4	55,0	31,0	58,7	30,2	11,5
1212289	-2024	1"1/4	1 1/4-11	1 1/2	59,0	31,0	69,9	35,7	13,5
1212290	-2420	1"1/2	1 1/2-11	1 1/4	56,0	37,0	58,7	30,2	11,5
1212291	-2424	1"1/2	1 1/2-11	1 1/2	61,0	37,0	69,9	35,7	13,5

Dimensions shown may be changed without prior notice

// R1A05M9334

90° adjustable flange SAE J518 code 61 - BSP - Low pressure

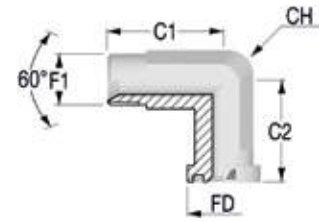

Item Code	Head / Flange	OD1 in	F1	Flange size	C1	C2	FD	CH
	Dash				mm	mm	mm	mm
1212266	-0608	3/8"	3/8-19	1/2	44,0	50,0	30,2	22,0
1212267	-0808	1/2"	1/2-14	1/2	48,0	42,0	30,2	22,0
1212268	-0812	1/2"	1/2-14	3/4	53,0	64,0	38,1	22,0
1212269	-1212	3/4"	3/4-14	3/4	53,0	64,0	38,1	27,0
1212270	-1216	3/4"	3/4-14	1	60,0	65,0	44,5	27,0
1212271	-1612	1"	1-11	3/4	53,0	64,0	38,1	34,0
1212272	-1616	1"	1-11	1	60,0	65,0	44,5	34,0
1212273	-1620	1"	1-11	1 1/4	55,0	64,0	50,8	34,0
1212274	-2016	1"1/4	1 1/4-11	1	60,0	65,0	44,5	42,0
1212275	-2020	1"1/4	1 1/4-11	1 1/4	55,0	64,0	50,8	42,0
1212276	-2024	1"1/4	1 1/4-11	1 1/2	66,0	78,0	60,3	42,0
1212277	-2424	1"1/2	1 1/2-11	1 1/2	66,0	78,0	60,3	50,0

// R1A05M9364

90° adjustable flange SAE J518 code 62 - BSP - High pressure

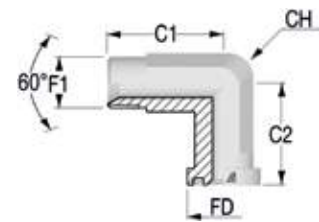

Item Code	Head / Flange	OD1 in	F1	Flange size	C1	C2	FD	CH
	Dash				mm	mm	mm	mm
1212292	-0608	3/8"	3/8-19	1/2	44,0	50,0	31,8	22,0
1212293	-0808	1/2"	1/2-14	1/2	49,0	43,0	31,8	22,0
1212294	-0812	1/2"	1/2-14	3/4	53,0	64,0	41,3	22,0
1212295	-1212	3/4"	3/4-14	3/4	53,0	64,0	41,3	27,0
1212296	-1216	3/4"	3/4-14	1	60,0	62,0	47,6	27,0
1212297	-1612	1"	1-11	3/4	59,5	54,5	41,3	30,0
1212298	-1616	1"	1-11	1	60,0	62,0	47,6	34,0
1212299	-1620	1"	1-11	1 1/4	70,0	72,0	54,0	34,0
1212300	-2016	1"1/4	1 1/4-11	1	72,0	70,0	47,6	41,0
1212301	-2020	1"1/4	1 1/4-11	1 1/4	70,0	72,0	54,0	42,0
1212302	-2024	1"1/4	1 1/4-11	1 1/2	80,0	84,0	63,5	42,0
1212303	-2424	1"1/2	1 1/2-11	1 1/2	80,0	84,0	63,5	50,0

// PLUG

// R1A0531000

Cap BSP 60° Female

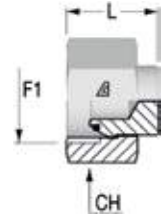

Item Code	Head	OD1	F1	CH	L
	Dash	in		mm	mm
1207690	-0400	1/4"	1/4-19	19,0	19,0
1207691	-0600	3/8"	3/8-19	22,0	21,0
1207692	-0800	1/2"	1/2-14	27,0	24,0
1207693	-1000	5/8"	5/8-14	27,0	26,0
1207694	-1200	3/4"	3/4-14	32,0	30,0
1207695	-1600	1"	1-11	38,0	32,0
1207696	-2000	1"1/4	1 1/4-11	50,0	32,0
1210712	-2400	1"1/2	1 1/2-11	55,0	38,0

// R1A05M1000

Plug BSP 60° Male

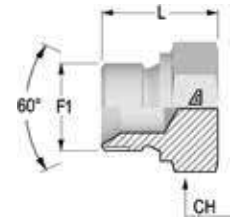

Item Code	Head	OD1	F1	CH	L
	Dash	in		mm	mm
1207662	-0200	1/8"	1/8-28	14,0	14,5
1207663	-0400	1/4"	1/4-19	19,0	19,0
1207664	-0600	3/8"	3/8-19	22,0	20,5
1207665	-0800	1/2"	1/2-14	27,0	24,0
1210952	-1000	5/8"	5/8-14	27,0	24,0
1207666	-1200	3/4"	3/4-14	32,0	26,5
1207667	-1600	1"	1-11	41,0	30,0
1207668	-2000	1"1/4	1 1/4-11	50,0	39,0
1207669	-2400	1"1/2	1 1/2-11	55,0	41,0



// DIN 24° ADAPTERS

// ACCESSORIES.....	278	// BSPP	310
// MALE UNION.....	281	// BSPT	322
// MALE / FEMALE UNION	285	// BUTT WELD	327
// BULKHEAD.....	296	// PLUG	329
// METRIC.....	298		

// ACCESSORIES

// R1A11D0000

Nut DIN 24° - Light series

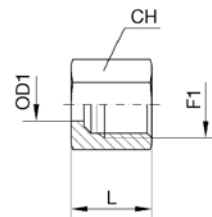

Item Code	Head	OD1 mm	F1	CH	L
	Dash			mm	mm
1204178	-0600	6	M12X1.5	14,0	14,50
1204181	-0800	8	M14X1.5	17,0	14,50
1204149	-1000	10	M16X1.5	19,0	15,50
1204152	-1200	12	M18X1.5	22,0	15,50
1204157	-1500	15	M22X1.5	27,0	17,00
1204160	-1800	18	M26X1.5	32,0	18,00
1204164	-2200	22	M30X2	36,0	20,00
1204167	-2800	28	M36X2	41,0	21,00
1204172	-3500	35	M45X2	50,0	24,00
1204177	-4200	42	M52X2	60,0	24,00

// R1A12D0000

Nut DIN 24° - Heavy series

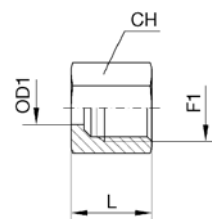

Item Code	Head	OD1 mm	F1	CH	L
	Dash			mm	mm
1204180	-0600	6	M14X1.5	17,0	16,50
1204182	-0800	8	M16X1.5	19,0	16,50
1204151	-1000	10	M18X1.5	22,0	17,50
1204154	-1200	12	M20X1.5	24,0	17,50
1204156	-1400	14	M22X1.5	27,0	20,50
1204159	-1600	16	M24X1.5	30,0	20,50
1204163	-2000	20	M30X2	36,0	24,00
1204166	-2500	25	M36X2	46,0	27,00
1204170	-3000	30	M42X2	50,0	29,00
1204175	-3800	38	M52X2	60,0	32,50

Dimensions shown may be changed without prior notice

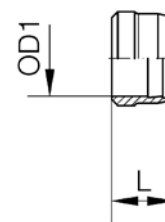
// R1A11R0000**Double cutting ring DIN 24° - Light series**

Item Code	Head mm	OD1 mm	L mm
1204137	-0600	6	9,5
1204139	-0800	8	9,5
1204109	-1000	10	10,0
1204113	-1200	12	10,0
1204118	-1500	15	10,0
1204121	-1800	18	10,5
1204125	-2200	22	11,0
1204129	-2800	28	11,0
1204133	-3500	35	13,5
1204136	-4200	42	13,5

Codes from 6 to 12mm also Heavy Series

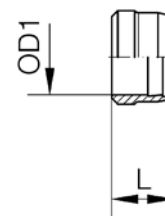
// R1A12R0000**Double cutting ring DIN 24° - Heavy series**

Item Code	Head mm	OD1 mm	L mm
1204117	-1400	14	10,0
1204120	-1600	16	10,5
1204124	-2000	20	13,0
1204128	-2500	25	13,0
1204131	-3000	30	13,5
1204135	-3800	38	13,5

Codes from 6 to 12mm same as Light Series ones

// R1A11R000B

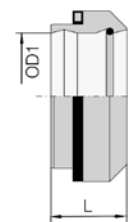
**Double cutting ring with tight sealing DIN 24° - Light series
DIN 2353**

Item Code	Head	OD1	L
	Dash	in	mm
1244467	-0600	6	9,0
1239498	-0800	8	8,0
1244468	-1000	10	9,3
1237046	-1200	12	9,5
1241104	-1500	15	9,5
1241106	-1800	18	9,5
1237047	-2200	22	11,5
1237048	-2800	28	11,5
1241110	-3500	35	13,0
1244469	-4200	42	13,0

Codes from 6 to 12mm also Heavy Series

// R1A12R000B

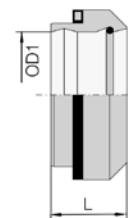
**Double cutting ring with tight sealing DIN 24° - Heavy series
DIN 2353**

Item Code	Head	OD1	L
	Dash	in	mm
1244470	-1400	14	10,0
1239871	-1600	16	10,0
1239870	-2000	20	13,0
1237071	-2500	25	13,3
1241138	-3000	30	14,0
1244471	-3800	38	14,0

Codes from 6 to 12mm same as Light Series ones

Dimensions shown may be changed without prior notice

// MALE UNION

// R1A11M111M

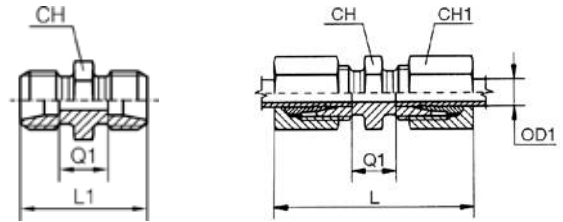
Straight union DIN 24° Male - Light series

Item Code Body Only	Item Code Complete	Head 1 / Head 2	OD1	Q1	CH	CH1	L	L1
		mm	mm	mm	mm	mm	mm	mm
1205544	1240805	-0606	6	10,0	12,0	14,0	39,0	24,0
1205546	1240806	-0808	8	11,0	14,0	17,0	40,0	25,0
1205537	1240807	-1010	10	13,0	17,0	19,0	42,0	27,0
1204233	1240808	-1212	12	14,0	19,0	22,0	43,0	28,0
1204234	1241077	-1515	15	16,0	24,0	27,0	46,0	30,0
1205538	1243784	-1818	18	16,0	27,0	32,0	48,0	31,0
1205541	1242417	-2222	22	20,0	32,0	36,0	52,0	35,0
1205708	1243785	-2828	28	21,0	41,0	41,0	54,0	36,0
1205709	1243786	-3535	35	20,0	46,0	50,0	63,0	41,0
1205710	1241080	-4242	42	21,0	55,0	60,0	66,0	43,0

// R1A12M112M

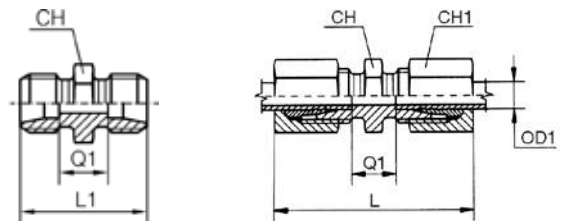
Straight union DIN 24° Male - Heavy series

Item Code Body Only	Item Code Complete	Head 1 / Head 2	OD1	Q1	CH	CH1	L	L1
		mm	mm	mm	mm	mm	mm	mm
1206097	1244127	-0606	6	16,0	14,0	17,0	45,0	30,0
1205687	1244128	-0808	8	18,0	17,0	19,0	47,0	32,0
1205688	1244129	-1010	10	17,0	19,0	22,0	49,0	32,0
1205689	1244130	-1212	12	19,0	22,0	24,0	51,0	34,0
1205690	1244131	-1414	14	22,0	24,0	27,0	57,0	38,0
1205691	1244132	-1616	16	21,0	27,0	30,0	57,0	38,0
1205539	1241122	-2020	20	23,0	32,0	36,0	66,0	44,0
1205542	1241125	-2525	25	26,0	41,0	46,0	74,0	50,0
1205543	1244133	-3030	30	27,0	46,0	50,0	80,0	54,0
1205711	1244134	-3838	38	29,0	55,0	60,0	90,0	61,0

// R1A11M911M

90° union DIN 24° Male - Light series

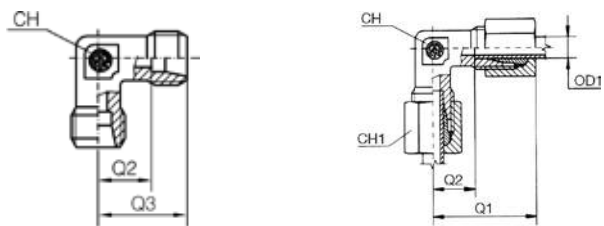

Item Code Body Only	Item Code Complete	Head 1 / Head 2	OD1	Q1	Q2	Q3	CH	CH1
		mm						
1205692	1243861	-0606	6	27,0	12,0	19,0	12,0	14,0
1205693	1241534	-0808	8	29,0	14,0	21,0	12,0	17,0
1205694	1240812	-1010	10	30,0	15,0	22,0	14,0	19,0
1204062	1243862	-1212	12	32,0	17,0	24,0	17,0	22,0
1204064	1243863	-1515	15	36,0	21,0	28,0	19,0	27,0
1205695	1243864	-1818	18	40,0	23,5	31,0	24,0	32,0
1205696	1243865	-2222	22	44,0	27,5	35,0	27,0	36,0
1205697	1243866	-2828	28	47,0	30,5	38,0	36,0	41,0
1205707	1243867	-3535	35	56,0	34,5	45,0	41,0	50,0
1206043	1243868	-4242	42	63,0	40,0	51,0	50,0	60,0

// R1A12M912M

90° union DIN 24° Male - Heavy series

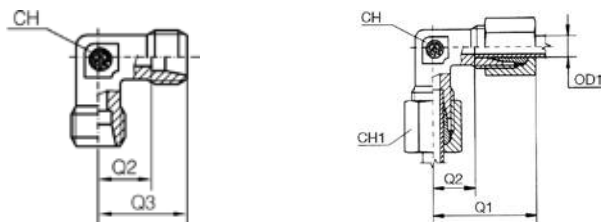

Item Code Body Only	Item Code Complete	Head 1 / Head 2	OD1	Q1	Q2	Q3	CH	CH1
		mm						
1205698	1244224	-0606	6	31,0	16,0	23,0	12,0	17,0
1205699	1244225	-0808	8	32,0	17,0	24,0	14,0	19,0
1205700	1244226	-1010	10	34,0	17,5	25,0	17,0	22,0
1205701	1244227	-1212	12	38,0	21,5	29,0	17,0	24,0
1205702	1244228	-1414	14	40,0	22,0	30,0	19,0	27,0
1205703	1244229	-1616	16	43,0	24,5	33,0	24,0	30,0
1205704	1244230	-2020	20	48,0	26,5	37,0	27,0	36,0
1242137	1205705	-2525	25	54,0	30,0	42,0	36,0	46,0
1205706	1244231	-3030	30	62,0	35,5	49,0	41,0	50,0
1207042	1244232	-3838	38	72,0	41,0	57,0	50,0	60,0

Dimensions shown may be changed without prior notice

// R1A11MT11M

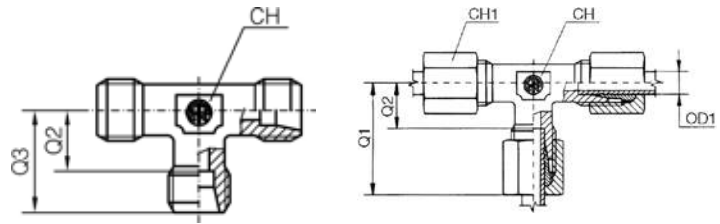
**Branch Tee union DIN 24° Male -
Light series**

Item Code Body Only	Item Code Complete	Head 1 / Head 2	OD1	Q1	Q2	Q3	CH	CH1
		mm						
1204218	1241542	-0606	6	27,0	12,0	19,0	12,0	14,0
1204219	1240813	-0808	8	29,0	14,0	21,0	12,0	17,0
1204215	1240814	-1010	10	30,0	15,0	22,0	14,0	19,0
1204216	1241099	-1212	12	32,0	17,0	24,0	17,0	22,0
1204217	1242245	-1515	15	36,0	21,0	28,0	19,0	27,0
1205712	1243981	-1818	18	40,0	23,5	31,0	24,0	32,0
1205713	1243982	-2222	22	44,0	27,5	35,0	27,0	36,0
1205714	1243983	-2828	28	47,0	30,5	38,0	36,0	41,0
1205715	1243984	-3535	35	56,0	34,5	45,0	41,0	50,0
1206042	1243985	-4242	42	63,0	40,0	51,0	50,0	60,0

// R1A12MT12M

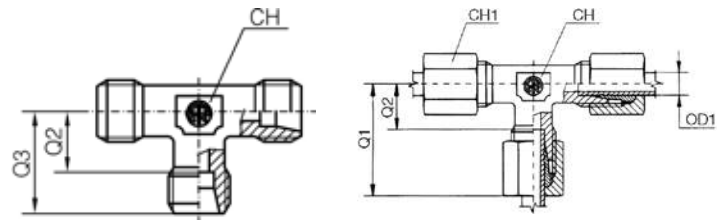
**Branch Tee union DIN 24° Male -
Heavy series**

Item Code Body Only	Item Code Complete	Head 1 / Head 2	OD1	Q1	Q2	Q3	CH	CH1
		mm						
1205716	1244350	-0606	6	31,0	16,0	23,0	12,0	17,0
1205717	1244351	-0808	8	32,0	17,0	24,0	14,0	19,0
1205718	1244352	-1010	10	34,0	17,5	25,0	17,0	22,0
1205719	1244353	-1212	12	38,0	21,5	29,0	17,0	24,0
1205720	1244354	-1414	14	40,0	22,0	30,0	19,0	27,0
1205616	1244355	-1616	16	43,0	24,5	33,0	24,0	30,0
1205721	1244356	-2020	20	48,0	26,5	37,0	27,0	36,0
1205722	1244357	-2525	25	54,0	30,0	42,0	36,0	46,0
1205723	1244358	-3030	30	62,0	35,5	49,0	41,0	50,0
1205724	1244359	-3838	38	72,0	41,0	57,0	50,0	60,0

// R1A11MX11M

Cross union DIN 24° Male - Light series

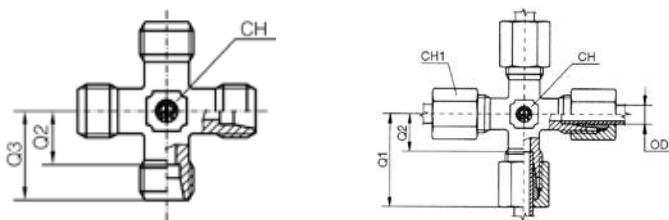

Item Code Body Only	Item Code Complete	Head 1 / Head 2	OD1	Q1	Q2	Q3	CH	CH1
		mm						
1205725	1244005	-0606	6	27,0	12,0	19,0	12,0	14,0
1205726	1244006	-0808	8	29,0	14,0	21,0	12,0	17,0
1205727	1242918	-1010	10	30,0	15,0	22,0	14,0	19,0
1205755	1244007	-1212	12	32,0	17,0	24,0	17,0	22,0
1205728	1244008	-1515	15	36,0	21,0	28,0	19,0	27,0
1205729	1244009	-1818	18	40,0	23,5	31,0	24,0	32,0
1205730	1244010	-2222	22	44,0	27,5	35,0	27,0	36,0
1211083	1244011	-2828	28	47,0	30,5	38,0	36,0	41,0
1211084	1244012	-3535	35	56,0	34,5	45,0	41,0	50,0
1211085	1244013	-4242	42	63,0	40,0	51,0	50,0	60,0

// R1A12MX12M

Cross union DIN 24° Male - Heavy series

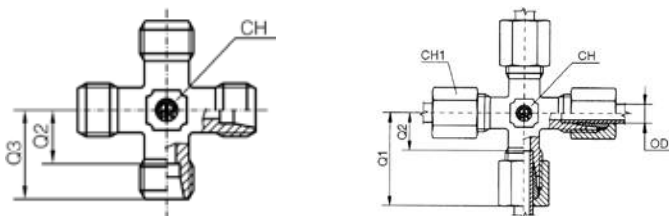

Item Code Body Only	Item Code Complete	Head 1 / Head 2	OD1	Q1	Q2	Q3	CH	CH1
		mm						
1206376	1244379	-0606	6	31,0	16,0	23,0	12,0	17,0
1206356	1244380	-0808	8	32,0	17,0	24,0	14,0	19,0
1206308	1244381	-1010	10	34,0	17,5	25,0	17,0	22,0
1206128	1244382	-1212	12	38,0	21,5	29,0	17,0	24,0
1206241	1244383	-1414	14	40,0	22,0	30,0	19,0	27,0
1206242	1244384	-1616	16	43,0	24,5	33,0	24,0	30,0
1206570	1244385	-2020	20	48,0	26,5	37,0	27,0	36,0
1206571	1244386	-2525	25	54,0	30,0	42,0	36,0	46,0
1208138	1244387	-3030	30	62,0	35,5	49,0	41,0	50,0
1211263	1244388	-3838	38	72,0	41,0	57,0	50,0	60,0

Dimensions shown may be changed without prior notice

// MALE / FEMALE UNION

// R1A11M1113

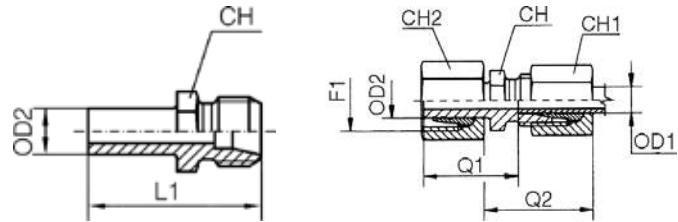
Reducers DIN 24° pre-assembled -
Light series

Item Code	Head 1 / Head 2	OD1 mm	OD2 mm	F1	Q1 mm	Q2 mm	L1 mm	CH mm	CH1 mm	CH2 mm
	mm									
1205622	-0608	8	6	M14X1.5	29,5	30,0	36,5	14,0	14,0	17,0
1205623	-0610	10	6	M16X1.5	29,5	30,0	36,5	14,0	14,0	19,0
1205617	-0612	12	6	M18X1.5	29,5	30,0	36,5	14,0	14,0	22,0
1205621	-0615	15	6	M22X1.5	29,5	29,0	36,5	17,0	14,0	27,0
1205627	-0618	18	6	M26X1.5	30,5	29,0	37,5	19,0	14,0	32,0
1207824	-0622	22	6	M30X2	33,5	32,0	40,5	24,0	14,0	36,0
1207825	-0628	28	6	M36X2	34,5	33,0	41,5	32,0	14,0	41,0
1210999	-0635	35	6	M45X2	40,5	34,0	47,5	36,0	14,0	50,0
1205624	-0810	10	8	M16X1.5	29,5	30,0	36,5	17,0	17,0	19,0
1205618	-0812	12	8	M18X1.5	29,5	30,0	36,5	17,0	17,0	22,0
1205620	-0815	15	8	M22X1.5	29,5	29,0	36,5	17,0	17,0	27,0
1205628	-0818	18	8	M26X1.5	30,5	29,0	37,5	19,0	17,0	32,0
1206843	-0822	22	8	M30X2	33,5	32,0	40,5	24,0	17,0	36,0
1207826	-0828	28	8	M36X2	34,5	33,0	41,5	32,0	17,0	41,0
1211000	-0835	35	8	M45X2	40,5	34,0	47,5	36,0	17,0	50,0
1205619	-1012	12	10	M18X1.5	31,0	31,0	38,0	17,0	19,0	22,0
1205625	-1015	15	10	M22X1.5	31,0	30,0	38,0	17,0	19,0	27,0
1205629	-1018	18	10	M26X1.5	32,0	30,0	39,0	19,0	19,0	32,0
1206562	-1022	22	10	M30X2	35,0	33,0	42,0	24,0	19,0	36,0
1207827	-1028	28	10	M36X2	36,0	34,0	43,0	32,0	19,0	41,0
1211001	-1035	35	10	M45X2	42,0	35,0	49,0	36,0	19,0	50,0
1211004	-1042	42	10	M52X2	44,0	36,0	51,0	46,0	19,0	60,0
1205626	-1215	15	12	M22X1.5	31,0	30,0	38,0	19,0	22,0	27,0
1205630	-1218	18	12	M26X1.5	32,0	30,0	39,0	19,0	22,0	32,0
1205632	-1222	22	12	M30X2	35,0	33,0	42,0	24,0	22,0	36,0
1205635	-1228	28	12	M36X2	36,0	34,0	43,0	32,0	22,0	41,0
1211002	-1235	35	12	M45X2	42,0	35,0	49,0	36,0	22,0	50,0
1211005	-1242	42	12	M52X2	43,0	36,0	50,0	46,0	22,0	60,0
1205631	-1518	18	15	M26X1.5	32,5	32,0	39,5	24,0	27,0	32,0
1205633	-1522	22	15	M30X2	35,5	35,0	42,5	24,0	27,0	36,0
1205636	-1528	28	15	M36X2	36,5	35,0	43,5	32,0	27,0	41,0
1211003	-1535	35	15	M45X2	42,5	36,0	49,5	36,0	27,0	50,0
1211006	-1542	42	15	M52X2	44,5	37,0	51,5	46,0	27,0	60,0
1205634	-1822	22	18	M30X2	35,0	35,0	42,5	27,0	32,0	36,0
1205637	-1828	28	18	M36X2	36,0	36,0	43,5	32,0	32,0	41,0
1208154	-1835	35	18	M45X2	42,0	37,0	49,5	36,0	32,0	50,0
1207828	-1842	42	18	M52X2	44,0	38,0	51,5	46,0	32,0	60,0
1205638	-2228	28	22	M36X2	36,0	38,0	43,5	32,0	36,0	41,0
1205639	-2235	35	22	M45X2	44,0	39,0	51,5	36,0	36,0	50,0
1205641	-2242	42	22	M52X2	46,0	40,0	53,5	46,0	36,0	60,0
1205640	-2835	35	28	M45X2	44,0	39,0	51,5	41,0	41,0	50,0

// R1A12M1123

Reducers DIN 24° pre-assembled - Heavy series

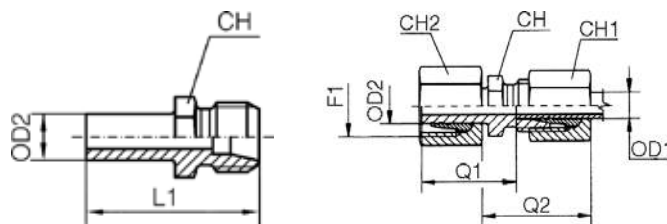

Item Code	Head 1 / Head 2	OD1 mm	OD2 mm	F1	Q1 mm	Q2 mm	L1 mm	CH mm	CH1 mm	CH2 mm
	mm									
1205644	-0608	8	6	M16X1.5	31,0	31,0	39,0	17,0	17,0	19,0
1205645	-0610	10	6	M18X1.5	32,0	31,0	39,0	17,0	17,0	22,0
1205647	-0612	12	6	M20X1.5	33,0	32,0	40,0	17,0	17,0	24,0
1206338	-0614	14	6	M22X1.5	37,0	34,0	44,0	17,0	17,0	27,0
1206340	-0616	16	6	M24X1.5	37,0	34,0	44,0	17,0	17,0	30,0
1207857	-0620	20	6	M30X2	43,0	36,0	50,0	22,0	17,0	36,0
1211188	-0625	25	6	M36X2	47,0	38,0	54,0	27,0	17,0	46,0
1211189	-0630	30	6	M42X2	49,0	37,0	56,0	32,0	17,0	50,0
1205646	-0810	10	8	M18X1.5	32,0	31,0	39,0	17,0	19,0	22,0
1205648	-0812	12	8	M20X1.5	33,0	32,0	40,0	17,0	19,0	24,0
1205650	-0814	14	8	M22X1.5	37,0	34,0	44,0	17,0	19,0	27,0
1205653	-0816	16	8	M24X1.5	37,0	34,0	44,0	17,0	19,0	30,0
1206362	-0820	20	8	M30X2	43,0	36,0	50,0	22,0	19,0	36,0
1206884	-0825	25	8	M36X2	47,0	38,0	54,0	27,0	19,0	46,0
1211190	-0830	30	8	M42X2	49,0	37,0	56,0	32,0	19,0	50,0
1205649	-1012	12	10	M20X1.5	32,5	33,0	40,0	19,0	22,0	24,0
1205651	-1014	14	10	M22X1.5	36,5	35,0	44,0	19,0	22,0	27,0
1205654	-1016	16	10	M24X1.5	36,5	35,0	44,0	19,0	22,0	30,0
1205657	-1020	20	10	M30X2	42,5	37,0	50,0	22,0	22,0	36,0
1205661	-1025	25	10	M36X2	46,5	39,0	54,0	27,0	22,0	46,0
1211191	-1030	30	10	M42X2	48,5	38,0	56,0	32,0	22,0	50,0
1205652	-1214	14	12	M22X1.5	36,5	35,0	44,0	22,0	24,0	27,0
1205658	-1220	20	12	M30X2	42,5	37,0	50,0	22,0	24,0	36,0
1205662	-1225	25	12	M36X2	46,5	39,0	54,0	27,0	24,0	46,0
1205663	-1230	30	12	M42X2	48,5	38,0	56,0	32,0	24,0	50,0
1205656	-1416	16	14	M24X1.5	38,0	38,0	46,0	24,0	27,0	30,0
1205659	-1420	20	14	M30X2	44,0	40,0	52,0	24,0	27,0	36,0
1206339	-1425	25	14	M36X2	48,0	42,0	56,0	27,0	27,0	46,0
1206846	-1430	30	14	M42X2	50,0	41,0	58,0	32,0	27,0	50,0
1211195	-1438	38	14	M52X2	57,0	42,0	65,0	41,0	27,0	60,0
1205660	-1620	20	16	M30X2	43,5	40,0	52,0	27,0	30,0	36,0
1205663	-1625	25	16	M36X2	47,5	42,0	56,0	27,0	30,0	46,0
1205665	-1630	30	16	M42X2	49,5	41,0	58,0	32,0	30,0	50,0
1207858	-1638	38	16	M52X2	56,5	42,0	65,0	41,0	30,0	60,0
1205664	-2025	25	20	M36X2	47,5	45,0	58,0	32,0	36,0	46,0
1205666	-2030	30	20	M42X2	49,5	45,0	60,0	32,0	36,0	50,0
1205668	-2038	38	20	M52X2	56,5	46,0	67,0	41,0	36,0	60,0
1205667	-2530	30	25	M42X2	50,0	48,0	62,0	41,0	46,0	50,0
1205669	-2538	38	25	M52X2	57,0	49,0	69,0	41,0	46,0	60,0

Dimensions shown may be changed without prior notice

// R1A11M1152

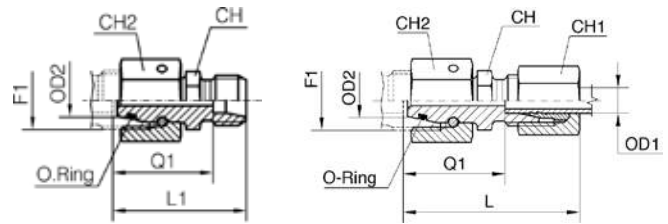
Reducers DIN 24° with O-Ring - Light series

Item Code Body Only	Item Code Complete	Head 1 / Head 2	OD1	OD2	F1	Q1	CH	CH1	CH2	L	L1
1211354	1243796	-0608	6	8	M12X1.5	23,5	12,0	14,0	17,0	38,0	30,5
1211355	1243797	-0610	6	10	M12X1.5	25,0	14,0	14,0	19,0	40,0	32,0
1211357	1243798	-0612	6	12	M12X1.5	25,0	17,0	14,0	22,0	40,0	32,0
1211359	1243799	-0615	6	15	M12X1.5	28,5	19,0	14,0	27,0	43,0	35,5
1211361	1243800	-0618	6	18	M12X1.5	28,0	24,0	14,0	32,0	43,0	35,0
1211365	1243801	-0622	6	22	M12X1.5	32,0	27,0	14,0	36,0	47,0	39,0
1211371	1243802	-0628	6	28	M12X1.5	34,0	32,0	14,0	41,0	49,0	41,0
1211356	1243803	-0810	8	10	M14X1.5	25,0	14,0	17,0	19,0	40,0	32,0
1208070	1243804	-0812	8	12	M14X1.5	25,0	17,0	17,0	22,0	40,0	32,0
1208071	1243805	-0815	8	15	M14X1.5	28,5	19,0	17,0	27,0	43,0	35,5
1211362	1243806	-0818	8	18	M14X1.5	28,0	24,0	17,0	32,0	43,0	35,0
1211366	1243807	-0822	8	22	M14X1.5	32,0	27,0	17,0	36,0	47,0	39,0
1211372	1243808	-0828	8	28	M14X1.5	34,0	32,0	17,0	41,0	49,0	41,0
1211358	1243809	-1012	10	12	M16X1.5	26,0	17,0	19,0	22,0	41,0	33,0
1208072	1243810	-1015	10	15	M16X1.5	29,5	19,0	19,0	27,0	44,0	36,5
1211363	1243811	-1018	10	18	M16X1.5	29,0	24,0	19,0	32,0	44,0	36,0
1211373	1243812	-1028	10	28	M16X1.5	35,0	32,0	19,0	41,0	50,0	42,0
1211360	1243813	-1215	12	15	M18X1.5	29,5	19,0	22,0	27,0	44,0	36,5
1208073	1243814	-1218	12	18	M18X1.5	29,0	24,0	22,0	32,0	44,0	36,0
1211367	1243815	-1222	12	22	M18X1.5	33,0	27,0	22,0	36,0	48,0	40,0
1211374	1243816	-1228	12	28	M18X1.5	35,0	32,0	22,0	41,0	50,0	42,0
1211364	1243817	-1518	15	18	M22X1.5	30,0	24,0	27,0	32,0	45,0	37,0
1211368	1243818	-1522	15	22	M22X1.5	34,0	27,0	27,0	36,0	49,0	41,0
1211375	1243819	-1528	15	28	M22X1.5	36,0	32,0	27,0	41,0	51,0	43,0
1211377	1243820	-1535	15	35	M22X1.5	39,0	41,0	27,0	50,0	54,0	46,0
1211369	1243821	-1822	18	22	M26X1.5	33,5	27,0	32,0	36,0	50,0	41,0
1208082	1243822	-1828	18	28	M26X1.5	36,5	32,0	32,0	41,0	52,0	44,0
1211378	1243823	-1835	18	35	M26X1.5	38,5	41,0	32,0	50,0	55,0	46,0
1211379	1243824	-1842	18	42	M26X1.5	42,0	50,0	32,0	60,0	58,0	49,5
1211376	1243825	-2228	22	28	M30X2	37,5	32,0	36,0	41,0	54,0	45,0
1208083	1243826	-2235	22	35	M30X2	40,5	41,0	36,0	50,0	57,0	48,0
1211380	1243827	-2242	22	42	M30X2	44,0	50,0	36,0	60,0	60,0	49,5
1211381	1243828	-2842	28	42	M36X2	44,0	50,0	41,0	60,0	61,0	51,5
1211382	1243829	-3542	35	42	M45X2	43,0	50,0	50,0	60,0	65,0	53,5

// R1A12M1162

Reducers DIN 24° with O-Ring - Heavy series

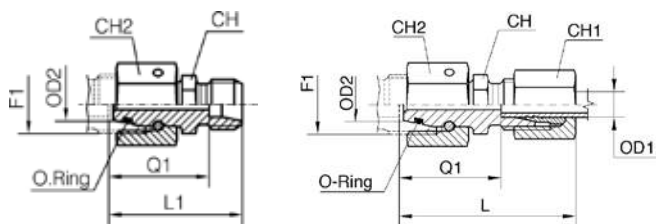

Item Code Body Only	Item Code Complete	Head 1 / Head 2	OD1 mm	OD2 mm	F1	Q1 mm	CH mm	CH1 mm	CH2 mm	L mm	L1 mm
		mm									
1211411	1244144	-0608	6	8	M14X1.5	27,0	14,0	17,0	19,0	42,0	34,0
1211412	1244145	-0610	6	10	M14X1.5	27,5	17,0	17,0	22,0	42,0	34,5
1211414	1244146	-0612	6	12	M14X1.5	29,0	17,0	17,0	24,0	44,0	36,0
1211417	1244147	-0614	6	14	M14X1.5	31,5	19,0	17,0	27,0	46,0	38,5
1207967	1244148	-0616	6	16	M14X1.5	32,0	22,0	17,0	30,0	47,0	39,0
1211423	1244149	-0620	6	20	M14X1.5	36,0	27,0	17,0	36,0	51,0	43,0
1211427	1244150	-0625	6	25	M14X1.5	38,5	32,0	17,0	46,0	53,0	45,5
1211433	1244151	-0630	6	30	M14X1.5	44,0	41,0	17,0	50,0	59,0	51,0
1211413	1244152	-0810	8	10	M16X1.5	27,5	17,0	19,0	22,0	42,0	34,5
1211415	1244153	-0812	8	12	M16X1.5	29,0	17,0	19,0	24,0	44,0	36,0
1211418	1244154	-0814	8	14	M16X1.5	31,5	19,0	19,0	27,0	46,0	38,5
1211421	1244155	-0816	8	16	M16X1.5	32,0	22,0	19,0	30,0	47,0	39,0
1211424	1244156	-0820	8	20	M16X1.5	36,0	27,0	19,0	36,0	51,0	43,0
1211428	1244157	-0825	8	25	M16X1.5	38,5	32,0	19,0	46,0	53,0	45,5
1211434	1244158	-0830	8	30	M16X1.5	44,0	41,0	19,0	50,0	59,0	51,0
1211416	1244159	-1012	10	12	M18X1.5	29,5	19,0	22,0	24,0	46,0	37,0
1211419	1244160	-1014	10	14	M18X1.5	31,0	19,0	22,0	27,0	47,0	38,5
1208068	1244161	-1016	10	16	M18X1.5	31,5	22,0	22,0	30,0	48,0	39,0
1211425	1244162	-1020	10	20	M18X1.5	35,5	27,0	22,0	36,0	52,0	43,0
1211429	1244163	-1025	10	25	M18X1.5	38,0	32,0	22,0	46,0	54,0	45,5
1211435	1244164	-1030	10	30	M18X1.5	43,5	41,0	22,0	50,0	60,0	51,0
1211420	1244165	-1214	12	14	M20X1.5	31,0	22,0	24,0	27,0	47,0	38,5
1242333	1244166	-1216	12	16	M20X1.5	31,5	22,0	24,0	30,0	48,0	39,0
1208165	1244167	-1220	12	20	M20X1.5	35,5	27,0	24,0	36,0	52,0	43,0
1211430	1244168	-1225	12	25	M20X1.5	38,0	32,0	24,0	46,0	54,0	45,5
1211436	1244169	-1230	12	30	M20X1.5	43,5	41,0	24,0	50,0	60,0	51,0
1211422	1244170	-1416	14	16	M22X1.5	33,0	24,0	27,0	30,0	51,0	41,0
1211426	1244171	-1420	14	20	M22X1.5	37,0	27,0	27,0	36,0	55,0	45,0
1211431	1244172	-1425	14	25	M22X1.5	39,5	32,0	27,0	46,0	57,0	47,5
1211437	1244173	-1430	14	30	M22X1.5	45,0	41,0	27,0	50,0	63,0	53,0
1211442	1244174	-1438	14	38	M22X1.5	48,5	50,0	27,0	60,0	66,0	56,5
1208166	1244175	-1620	16	20	M24X1.5	36,5	27,0	30,0	36,0	55,0	45,0
1208167	1244176	-1625	16	25	M24X1.5	39,0	32,0	30,0	46,0	57,0	47,5
1211438	1244177	-1630	16	30	M24X1.5	44,5	41,0	30,0	50,0	63,0	54,0
1211443	1244178	-1638	16	38	M24X1.5	48,0	50,0	30,0	60,0	66,0	56,5
1211432	1244179	-2025	20	25	M30X2	39,0	32,0	36,0	46,0	61,0	49,5
1207987	1244180	-2030	20	30	M30X2	44,5	41,0	36,0	50,0	66,0	55,0
1211444	1244181	-2038	20	38	M30X2	48,0	50,0	36,0	60,0	70,0	58,5
1207963	1244182	-2530	25	30	M36X2	45,0	41,0	46,0	50,0	69,0	57,0
1211445	1244183	-2538	25	38	M36X2	48,5	50,0	46,0	60,0	73,0	60,5
1211446	1244184	-3038	30	38	M42X2	49,0	50,0	50,0	60,0	76,0	62,5

Dimensions shown may be changed without prior notice

// R1A11M4152

**45° adjustable elbow connector DIN
24° Male - Female with O-Ring - Light
series**

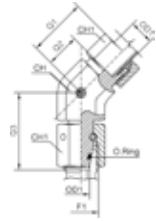
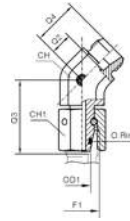

Item Code Body Only	Item Code Complete	Head 1 / Head 2	OD1 mm	F1	Q1 mm	Q2 mm	Q3 mm	Q4 mm	CH mm	CH1 mm
		mm								
1244869	1244939	-0606	6	M12X1.5	24,5	9,5	26,0	16,5	14,0	14,0
1244870	1244940	-0808	8	M14X1.5	27,0	12,0	27,5	19,0	14,0	17,0
1241985	1244941	-1010	10	M16X1.5	27,0	12,0	29,0	19,0	19,0	19,0
1208305	1244942	-1212	12	M18X1.5	29,0	14,0	29,5	21,0	19,0	22,0
1244871	1244943	-1515	15	M22X1.5	32,0	17,0	32,5	24,0	22,0	27,0
1244872	1244944	-1818	18	M26X1.5	33,0	17,0	35,5	24,5	27,0	32,0
1244873	1244945	-2222	22	M30X2	35,5	19,5	38,5	27,0	33,0	36,0
1244874	1244946	-2828	28	M36X2	39,0	23,0	41,5	30,5	41,0	41,0
1244875	1244947	-3535	35	M45X2	48,0	27,0	51,0	37,5	48,0	50,0
1244876	1244948	-4242	42	M52X2	49,0	26,0	56,0	37,0	48,0	60,0

// R1A12M4162

**45° adjustable elbow connector DIN
24° Male - Female with O-Ring -
Heavy series**

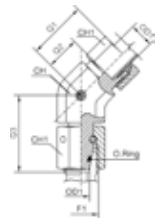
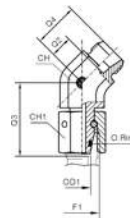

Item Code Body Only	Item Code Complete	Head 1 / Head 2	OD1 mm	F1	Q1 mm	Q2 mm	Q3 mm	Q4 mm	CH mm	CH1 mm
		mm								
1244894	1245008	-0606	6	M14X1.5	26,0	11,0	27,0	18,0	14,0	17,0
1244895	1245009	-0808	8	M16X1.5	28,0	13,0	27,5	20,0	19,0	19,0
1244896	1245010	-1010	10	M18X1.5	29,0	13,0	30,0	20,5	19,0	22,0
1244897	1245011	-1212	12	M20X1.5	33,0	17,0	31,0	24,5	22,0	24,0
1244898	1245012	-1616	16	M24X1.5	34,0	16,0	36,5	24,5	27,0	30,0
1244899	1245013	-2020	20	M30X2	40,0	19,0	44,5	29,5	33,0	36,0
1244900	1245014	-2525	25	M36X2	46,0	22,0	50,0	34,0	41,0	46,0
1244901	1245015	-3030	30	M42X2	50,0	24,0	55,0	37,5	48,0	50,0
1244902	1245016	-3838	38	M52X2	55,0	24,0	63,0	40,0	48,0	60,0

// R1A11M9113

**90° adjustable elbow connector DIN
24° Male - Female pre-assembled -
Light series**

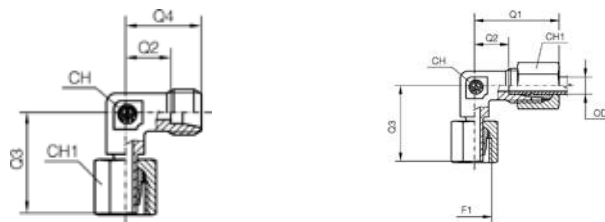

Item Code Body Only	Item Code Complete	Head 1 / Head 2	OD1	F1	Q1	Q2	Q3	Q4	CH	CH1
		mm								
1206164	1241531	-0606	6	M12X1.5	27,0	12,0	26,0	19,0	12,0	14,0
1205536	1240810	-0808	8	M14X1.5	29,0	14,0	27,5	21,0	12,0	17,0
1204070	1240811	-1010	10	M16X1.5	30,0	15,0	29,0	22,0	14,0	19,0
1242246	1241532	-1212	12	M18X1.5	32,0	17,0	29,5	24,0	17,0	22,0
1204072	1241533	-1515	15	M22X1.5	36,0	21,0	32,5	28,0	19,0	27,0
1205756	1243857	-1818	18	M26X1.5	40,0	23,5	35,5	31,0	24,0	32,0
1205731	1243858	-2222	22	M30X2	44,0	27,5	38,5	35,0	27,0	36,0
1206045	1243859	-2828	28	M36X2	47,0	30,5	41,5	38,0	36,0	41,0
1206044	1243860	-3535	35	M45X2	56,0	34,5	51,0	45,0	41,0	50,0
1205535	1241092	-4242	42	M52X2	63,0	40,0	60,0	51,0	50,0	60,0

// R1A12M9123

**90° adjustable elbow connector DIN
24° Male - Female pre-assembled -
Heavy series**

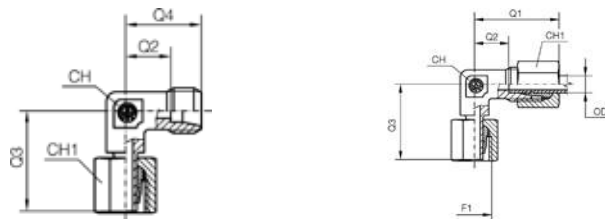

Item Code Body Only	Item Code Complete	Head 1 / Head 2	OD1	F1	Q1	Q2	Q3	Q4	CH	CH1
		mm								
1206278	1244214	-0606	6	M14X1.5	31,0	16,0	27,0	23,0	12,0	17,0
1205732	1244215	-0808	8	M16X1.5	32,0	17,0	27,5	24,0	14,0	19,0
1205563	1244216	-1010	10	M18X1.5	34,0	17,5	30,0	25,0	17,0	22,0
1205757	1244217	-1212	12	M20X1.5	38,0	21,5	31,0	29,0	17,0	24,0
1205733	1244218	-1414	14	M22X1.5	40,0	22,0	35,0	30,0	19,0	27,0
1205532	1244219	-1616	16	M24X1.5	43,0	24,5	36,5	33,0	24,0	30,0
1205533	1244220	-2020	20	M30X2	48,0	26,5	44,5	37,0	27,0	36,0
1205534	1244221	-2525	25	M36X2	54,0	30,0	50,0	42,0	36,0	46,0
1205734	1244222	-3030	30	M42X2	62,0	35,5	55,0	49,0	41,0	50,0
1206412	1244223	-3838	38	M52X2	72,0	41,0	64,5	57,0	50,0	60,0

Dimensions shown may be changed without prior notice

// R1A11M9152

**90° adjustable elbow connector DIN
24° Male - Female with O-Ring - Light
series**



Item Code Body Only	Item Code Complete	Head 1 / Head 2	OD1	F1	Q1	Q2	Q3	Q4	CH	CH1
		mm								
1211396	1243869	-0606	6	M12X1.5	27,0	12,0	26,0	20,0	12,0	14,0
1207070	1243870	-0808	8	M14X1.5	29,0	14,0	27,5	21,0	12,0	17,0
1244462	1206816	-1010	10	M16X1.5	30,0	15,0	29,0	22,5	17,0	19,0
1206852	1243871	-1212	12	M18X1.5	32,0	17,0	29,5	24,0	17,0	22,0
1206853	1243872	-1515	15	M22X1.5	36,0	21,0	32,5	28,0	19,0	27,0
1206854	1243873	-1818	18	M26X1.5	40,0	23,5	35,5	31,0	24,0	32,0
1206855	1243874	-2222	22	M30X2	44,0	27,5	38,5	35,0	27,0	36,0
1211397	1243875	-2828	28	M36X2	47,0	30,5	41,5	38,0	36,0	41,0
1208087	1243876	-3535	35	M45X2	56,0	34,5	51,0	45,0	41,0	50,0
1211398	1243877	-4242	42	M52X2	63,0	40,0	56,0	51,0	50,0	60,0

// R1A12M9162

**90° adjustable elbow connector DIN
24° Male - Female with O-Ring -
Heavy series**

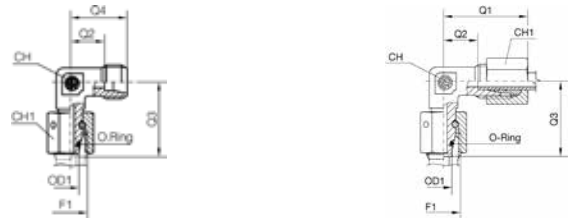

Item Code Body Only	Item Code Complete	Head 1 / Head 2	OD1	F1	Q1	Q2	Q3	Q4	CH	CH1
		mm								
1208183	1244233	-0606	6	M14X1.5	31,0	16,0	27,0	23,0	12,0	17,0
1206824	1244234	-0808	8	M16X1.5	32,0	17,0	27,5	24,0	14,0	19,0
1211456	1244235	-1010	10	M18X1.5	34,0	17,5	30,0	25,0	17,0	22,0
1206823	1244236	-1212	12	M20X1.5	38,0	21,5	31,0	29,0	17,0	24,0
1208186	1244237	-1414	14	M22X1.5	40,0	22,0	35,0	30,0	19,0	27,0
1207073	1244238	-1616	16	M24X1.5	43,0	24,5	36,5	33,0	24,0	30,0
1207074	1244239	-2020	20	M30X2	48,0	26,5	44,5	37,0	27,0	36,0
1241699	1207075	-2525	25	M36X2	54,0	30,0	50,0	42,0	36,0	46,0
1207076	1244240	-3030	30	M42X2	62,0	35,5	55,0	49,0	41,0	50,0
1211457	1244241	-3838	38	M52X2	72,0	41,0	63,0	57,0	50,0	60,0

// R1A11MT113

Branch Tee adjustable elbow connector DIN 24° Male - Female pre-assembled - Light series

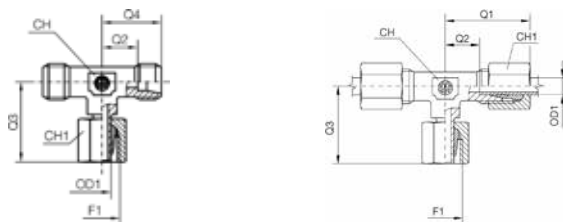

Item Code Body Only	Item Code Complete	Head 1 / Head 2	OD1	F1	Q1	Q2	Q3	Q4	CH	CH1
		mm								
1204222	1243974	-0606	6	M12X1.5	27,0	12,0	26,0	19,0	12,0	14,0
1205477	1241539	-0808	8	M14X1.5	29,0	14,0	27,5	21,0	12,0	17,0
1205735	1241540	-1010	10	M16X1.5	30,0	15,0	29,0	22,0	14,0	19,0
1205522	1241541	-1212	12	M18X1.5	32,0	17,0	29,5	24,0	17,0	22,0
1205676	1243975	-1515	15	M22X1.5	36,0	21,0	32,5	28,0	19,0	27,0
1205758	1243976	-1818	18	M26X1.5	40,0	23,5	35,5	31,0	24,0	32,0
1205736	1243977	-2222	22	M30X2	44,0	27,5	38,5	35,0	27,0	36,0
1206279	1243978	-2828	28	M36X2	47,0	30,5	41,5	38,0	36,0	41,0
1206584	1243979	-3535	35	M45X2	56,0	34,5	51,0	45,0	41,0	50,0
1206585	1243980	-4242	42	M52X2	63,0	40,0	60,0	51,0	50,0	60,0

// R1A12MT123

Branch Tee adjustable elbow connector DIN 24° Male - BSP Male with O-Ring - Heavy series

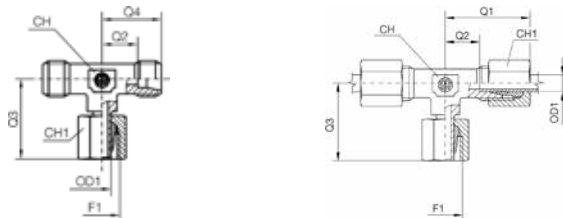

Item Code Body Only	Item Code Complete	Head 1 / Head 2	OD1	F1	Q1	Q2	Q3	Q4	CH	CH1
		mm								
1206355	1244340	-0606	6	M14X1.5	31,0	16,0	27,0	23,0	12,0	17,0
1206373	1244341	-0808	8	M16X1.5	32,0	17,0	27,5	24,0	14,0	19,0
1205581	1244342	-1010	10	M18X1.5	34,0	17,5	30,0	25,0	17,0	22,0
1205737	1244343	-1212	12	M20X1.5	38,0	21,5	31,0	29,0	17,0	24,0
1206280	1244344	-1414	14	M22X1.5	40,0	22,0	35,0	30,0	19,0	27,0
1205738	1244345	-1616	16	M24X1.5	43,0	24,5	36,5	33,0	24,0	30,0
1205739	1244346	-2020	20	M30X2	48,0	26,5	44,5	37,0	27,0	36,0
1206281	1244347	-2525	25	M36X2	54,0	30,0	50,0	42,0	36,0	46,0
1206297	1244348	-3030	30	M42X2	62,0	35,5	55,0	49,0	41,0	50,0
1206587	1244349	-3838	38	M52X2	72,0	41,0	64,5	57,0	50,0	60,0

Dimensions shown may be changed without prior notice

// R1A11MT152

Branch Tee adjustable elbow connector DIN 24° Male - Female with O-Ring - Light series

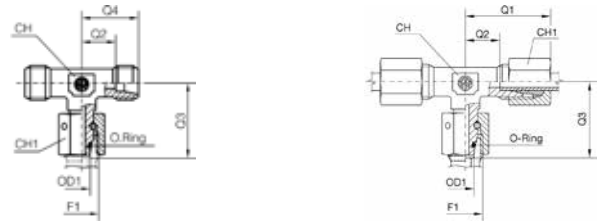

Item Code Body Only	Item Code Complete	Head 1 / Head 2	OD1 mm	F1	Q1 mm	Q2 mm	Q3 mm	Q4 mm	CH mm	CH1 mm
		mm								
1211350	1243986	-0606	6	M12X1.5	27,0	12,0	26,0	20,0	12,0	14,0
1208058	1243987	-0808	8	M14X1.5	29,0	14,0	27,5	21,0	12,0	17,0
1206856	1243988	-1010	10	M16X1.5	30,0	15,0	29,0	22,5	14,0	19,0
1210689	1241143	-1212	12	M18X1.5	32,0	17,0	29,5	24,0	17,0	22,0
1208059	1243989	-1515	15	M22X1.5	36,0	21,0	32,5	28,0	19,0	27,0
1208060	1243990	-1818	18	M26X1.5	40,0	23,5	35,5	31,0	24,0	32,0
1211351	1243991	-2222	22	M30X2	44,0	27,5	38,5	35,0	27,0	36,0
1211352	1243992	-2828	28	M36X2	47,0	30,5	41,5	38,0	36,0	41,0
1208061	1243993	-3535	35	M45X2	56,0	34,5	51,0	45,0	41,0	50,0
1211353	1243994	-4242	42	M52X2	63,0	40,0	56,0	51,0	50,0	60,0

// R1A12MT162

Branch Tee adjustable elbow connector DIN 24° Male - Female with O-Ring - Heavy series

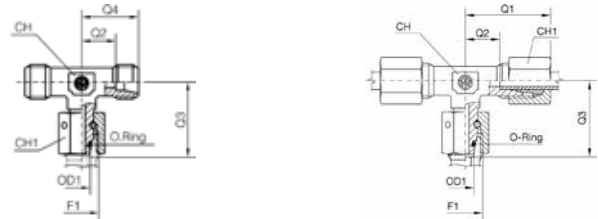

Item Code Body Only	Item Code Complete	Head 1 / Head 2	OD1 mm	F1	Q1 mm	Q2 mm	Q3 mm	Q4 mm	CH mm	CH1 mm
		mm								
1211404	1244360	-0606	6	M14X1.5	31,0	16,0	27,0	23,0	12,0	17,0
1211405	1244361	-0808	8	M16X1.5	32,0	17,0	27,5	24,0	14,0	19,0
1208196	1244362	-1010	10	M18X1.5	34,0	17,5	30,0	25,0	17,0	22,0
1208197	1244363	-1212	12	M20X1.5	38,0	21,5	31,0	29,0	17,0	24,0
1211406	1244364	-1414	14	M22X1.5	40,0	22,0	35,0	30,0	19,0	27,0
1207470	1244365	-1616	16	M24X1.5	43,0	24,5	36,5	33,0	24,0	30,0
1211407	1244366	-2020	20	M30X2	48,0	26,5	44,5	37,0	27,0	36,0
1211408	1244367	-2525	25	M36X2	54,0	30,0	50,0	42,0	36,0	46,0
1211409	1244368	-3030	30	M42X2	62,0	35,5	55,0	49,0	41,0	50,0
1211410	1244369	-3838	38	M52X2	72,0	41,0	63,0	57,0	50,0	60,0

// R1A11ML113

**Run Tee adjustable elbow connector
DIN 24° Male - Female pre-
assembled - Light series**

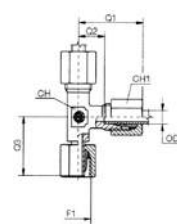
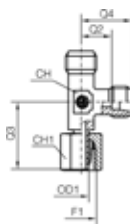

Item Code Body Only	Item Code Complete	Head 1 / Head 2	OD1	F1	Q1	Q2	Q3	Q4	CH	CH1
		mm	mm		mm	mm	mm	mm	mm	mm
1205478	1241964	-0606	6	M12X1.5	27,0	12,0	26,0	19,0	12,0	14,0
1205479	1241535	-0808	8	M14X1.5	29,0	14,0	27,5	21,0	12,0	17,0
1205677	1241702	-1010	10	M16X1.5	30,0	15,0	29,0	22,0	14,0	19,0
1242248	1241536	-1212	12	M18X1.5	32,0	17,0	29,5	24,0	17,0	22,0
1204221	1241537	-1515	15	M22X1.5	36,0	21,0	32,5	28,0	19,0	27,0
1205529	1243939	-1818	18	M26X1.5	40,0	23,5	35,5	31,0	24,0	32,0
1205759	1243940	-2222	22	M30X2	44,0	27,5	38,5	35,0	27,0	36,0
1206072	1243941	-2828	28	M36X2	47,0	30,5	41,5	38,0	36,0	41,0
1206129	1243942	-3535	35	M45X2	56,0	34,5	51,0	45,0	41,0	50,0
1206586	1243943	-4242	42	M52X2	63,0	40,0	60,0	51,0	50,0	60,0

// R1A12ML123

**Run Tee adjustable elbow connector
DIN 24° Male - Female pre-
assembled - Heavy series**

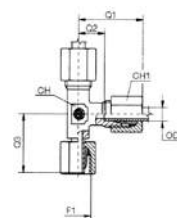
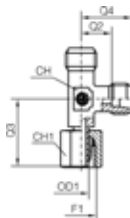

Item Code Body Only	Item Code Complete	Head 1 / Head 2	OD1	F1	Q1	Q2	Q3	Q4	CH	CH1
		mm	mm		mm	mm	mm	mm	mm	mm
1206354	1244302	-0606	6	M14X1.5	31,0	16,0	27,0	23,0	12,0	17,0
1206367	1244303	-0808	8	M16X1.5	32,0	17,0	27,5	24,0	14,0	19,0
1205580	1244304	-1010	10	M18X1.5	34,0	17,5	30,0	25,0	17,0	22,0
1206179	1244305	-1212	12	M20X1.5	38,0	21,5	31,0	29,0	17,0	24,0
1206130	1244306	-1414	14	M22X1.5	40,0	22,0	35,0	30,0	19,0	27,0
1206010	1244307	-1616	16	M24X1.5	43,0	24,5	36,5	33,0	24,0	30,0
1205678	1244308	-2020	20	M30X2	48,0	26,5	44,5	37,0	27,0	36,0
1206255	1244309	-2525	25	M36X2	54,0	30,0	50,0	42,0	36,0	46,0
1205574	1244310	-3030	30	M42X2	62,0	35,5	55,0	49,0	41,0	50,0
1206588	1244311	-3838	38	M52X2	72,0	41,0	64,5	57,0	50,0	60,0

Dimensions shown may be changed without prior notice

// R1A11ML152

**Run Tee adjustable elbow connector
DIN 24° Male - Female with O-Ring -
Light series**

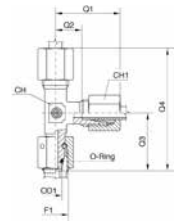
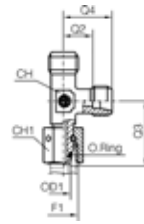

Item Code Body Only	Item Code Complete	Head 1 / Head 2	OD1 mm	F1	Q1 mm	Q2 mm	Q3 mm	Q4 mm	CH mm	CH1 mm
		mm								
1211347	1243944	-0606	6	M12X1.5	27,0	12,0	26,0	20,0	12,0	14,0
1208088	1243945	-0808	8	M14X1.5	29,0	14,0	27,5	21,0	12,0	17,0
1206813	1243946	-1010	10	M16X1.5	30,0	15,0	29,0	22,5	14,0	19,0
1206889	1243947	-1212	12	M18X1.5	32,0	17,0	29,5	24,0	17,0	22,0
1207522	1243948	-1515	15	M22X1.5	36,0	21,0	32,5	28,0	19,0	27,0
1208089	1243949	-1818	18	M26X1.5	40,0	23,5	35,5	31,0	24,0	32,0
1207518	1243950	-2222	22	M30X2	44,0	27,5	38,5	35,0	27,0	36,0
1208090	1243951	-2828	28	M36X2	47,0	30,5	41,5	38,0	36,0	41,0
1211348	1243952	-3535	35	M45X2	56,0	34,5	51,0	45,0	41,0	50,0
1211349	1243953	-4242	42	M52X2	63,0	40,0	56,0	51,0	50,0	60,0

// R1A12ML162

**Run Tee adjustable elbow connector
DIN 24° Male - Female with O-Ring -
Heavy series**

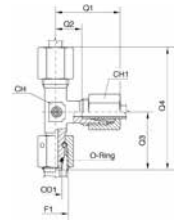
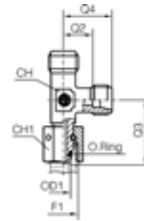

Item Code Body Only	Item Code Complete	Head 1 / Head 2	OD1 mm	F1	Q1 mm	Q2 mm	Q3 mm	Q4 mm	CH mm	CH1 mm
		mm								
1211400	1244312	-0606	6	M14X1.5	31,0	16,0	27,0	23,0	12,0	17,0
1207087	1244313	-0808	8	M16X1.5	32,0	17,0	27,5	24,0	14,0	19,0
1211401	1244314	-1010	10	M18X1.5	34,0	17,5	30,0	25,0	17,0	22,0
1208190	1244315	-1212	12	M20X1.5	38,0	21,5	31,0	29,0	17,0	24,0
1206883	1244316	-1414	14	M22X1.5	40,0	22,0	35,0	30,0	19,0	27,0
1211402	1244317	-1616	16	M24X1.5	43,0	24,5	36,5	33,0	24,0	30,0
1208193	1244318	-2020	20	M30X2	48,0	26,5	44,5	37,0	27,0	36,0
1207086	1244319	-2525	25	M36X2	54,0	30,0	50,0	42,0	36,0	46,0
1211403	1244320	-3030	30	M42X2	62,0	35,5	55,0	49,0	41,0	50,0
1208194	1244321	-3838	38	M52X2	72,0	41,0	63,0	57,0	50,0	60,0

// BULKHEAD

// R1A11T111M

Straight union DIN 24° Bulkhead - Light series

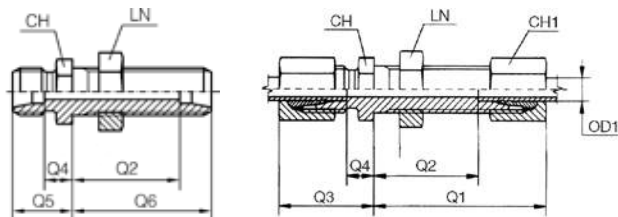

Item Code Body Only	Item Code Complete	Head 1 / Head 2	OD1	F1	Q1	Q2	Q3	Q4	Q5	CH	CH1	LN
		mm			mm	mm	mm	mm	mm	mm	mm	mm
1206125	1244014	-0606	6	M12X1.5	42,0	27,0	22,0	7,0	14,0	17,0	14,0	17,0
1205545	1240816	-0808	8	M14X1.5	42,0	27,0	23,0	8,0	15,0	19,0	17,0	19,0
1206243	1240818	-1010	10	M16X1.5	43,0	28,0	25,0	10,0	17,0	22,0	19,0	22,0
1205892	1241544	-1212	12	M18X1.5	44,0	29,0	25,0	10,0	17,0	24,0	22,0	24,0
1205679	1241546	-1515	15	M22X1.5	46,0	31,0	27,0	12,0	19,0	27,0	27,0	30,0
1206126	1244015	-1818	18	M26X1.5	49,0	32,5	30,0	13,5	19,0	32,0	32,0	36,0
1205540	1244016	-2222	22	M30X2	51,0	34,5	33,0	16,5	24,0	36,0	36,0	41,0
1206071	1244017	-2828	28	M36X2	52,0	35,5	35,0	18,5	26,0	41,0	41,0	46,0
1206244	1244018	-3535	35	M45X2	58,0	36,5	40,0	18,5	29,0	50,0	50,0	55,0
1207043	1244019	-4242	42	M52X2	59,0	36,0	42,0	19,0	30,0	60,0	60,0	65,0

// R1A12T112M

Straight union DIN 24° Bulkhead - Heavy series

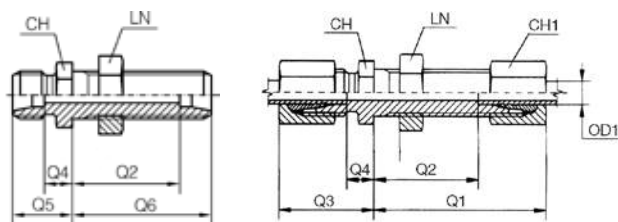

Item Code Body Only	Item Code Complete	Head 1 / Head 2	OD1	F1	Q1	Q2	Q3	Q4	Q5	CH	CH1	LN
		mm			mm	mm	mm	mm	mm	mm	mm	mm
1206358	1244389	-0606	6	M14X1.5	44,0	29,0	27,0	12,0	19,0	19,0	17,0	19,0
1205969	1244390	-0808	8	M16X1.5	44,0	29,0	28,0	13,0	20,0	22,0	19,0	22,0
1206245	1244391	-1010	10	M18X1.5	46,0	29,5	31,0	14,5	22,0	24,0	22,0	24,0
1206247	1244392	-1212	12	M20X1.5	47,0	30,5	31,0	14,5	22,0	27,0	24,0	27,0
1206246	1244393	-1414	14	M22X1.5	50,0	32,0	35,0	17,0	25,0	30,0	27,0	30,0
1205970	1243660	-1616	16	M24X1.5	50,0	31,5	35,0	16,5	25,0	32,0	30,0	32,0
1205957	1244394	-2020	20	M30X2	55,0	33,5	39,0	17,5	28,0	41,0	36,0	41,0
1206127	1244395	-2525	25	M36X2	59,0	35,0	44,0	20,0	32,0	46,0	46,0	46,0
1205575	1244396	-3030	30	M42X2	64,0	37,5	48,0	21,5	35,0	50,0	50,0	50,0
1206417	1244397	-3838	38	M52X2	68,0	37,0	53,0	22,0	38,0	65,0	60,0	65,0

Dimensions shown may be changed without prior notice

// R1A11T911M

90° union DIN 24° Bulkhead - Light series

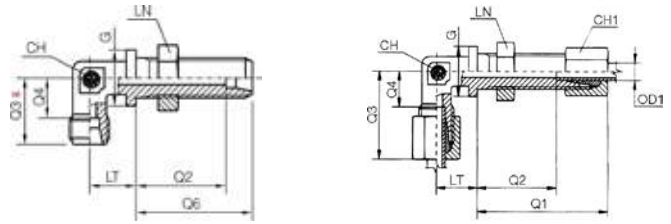

Item Code Body Only	Item Code Complete	Head 1 / Head 2	OD1	F1	Q1	Q2	Q3	Q4	Q5	LT	CH	CH1	LN
		mm											
1206248	1241547	-0606	6	M12X1.5	42,0	27,0	27,0	12,0	19,0	14,0	12,0	14,0	17,0
1206249	1241548	-0808	8	M14X1.5	42,0	27,0	29,0	14,0	21,0	17,0	12,0	17,0	19,0
1206250	1241549	-1010	10	M16X1.5	43,0	28,0	30,0	15,0	22,0	18,0	14,0	19,0	22,0
1206251	1244020	-1212	12	M18X1.5	44,0	29,0	32,0	17,0	24,0	20,0	17,0	22,0	24,0
1205686	1244021	-1515	15	M22X1.5	46,0	31,0	36,0	21,0	28,0	23,0	19,0	27,0	30,0
1206252	1244022	-1818	18	M26X1.5	49,0	32,5	40,0	23,5	31,0	24,0	24,0	32,0	36,0
1206253	1244023	-2222	22	M30X2	51,0	34,5	44,0	27,5	35,0	30,0	27,0	36,0	41,0
1206357	1244024	-2828	28	M36X2	52,0	35,5	47,0	30,5	38,0	34,0	36,0	41,0	46,0
1206254	1244025	-3535	35	M45X2	58,0	36,5	56,0	34,5	45,0	39,0	41,0	50,0	55,0
1206820	1244026	-4242	42	M52X2	59,0	36,0	63,0	40,0	51,0	43,0	50,0	60,0	65,0

// R1A12T912M

90° union DIN 24° Bulkhead - Heavy series

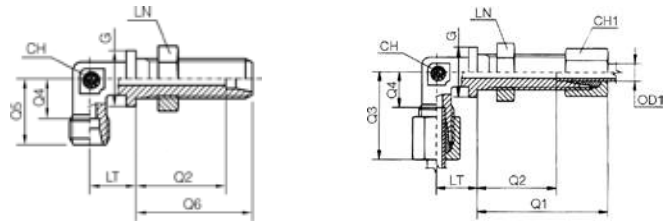

Item Code Body Only	Item Code Complete	Head 1 / Head 2	OD1	F1	Q1	Q2	Q3	Q4	Q5	LT	CH	CH1	LN
		mm											
1207147	1244398	-0606	6	M14X1.5	44,0	29,0	31,0	16,0	23,0	17,0	12,0	17,0	19,0
1206374	1244399	-0808	8	M16X1.5	44,0	29,0	32,0	17,0	24,0	18,0	14,0	19,0	22,0
1206256	1244400	-1010	10	M18X1.5	46,0	29,5	34,0	17,5	25,0	20,0	17,0	22,0	24,0
1206260	1244401	-1212	12	M20X1.5	47,0	30,5	38,0	21,5	29,0	21,0	17,0	24,0	27,0
1206257	1244402	-1414	14	M22X1.5	50,0	32,0	40,0	22,0	30,0	23,0	19,0	27,0	30,0
1206258	1243661	-1616	16	M24X1.5	50,0	31,5	43,0	24,5	33,0	24,0	24,0	30,0	32,0
1206259	1244403	-2020	20	M30X2	55,0	33,5	48,0	26,5	37,0	30,0	27,0	36,0	41,0
1206261	1244404	-2525	25	M36X2	59,0	35,0	54,0	30,0	42,0	34,0	36,0	46,0	46,0
1207148	1244405	-3030	30	M42X2	64,0	37,5	62,0	35,5	49,0	39,0	41,0	50,0	50,0
1207149	1244406	-3838	38	M52X2	68,0	37,0	72,0	41,0	57,0	43,0	50,0	60,0	65,0

// METRIC

// R1A11M150M

**Straight connector DIN 24° Male -
Metric cylindric Male - Light series**

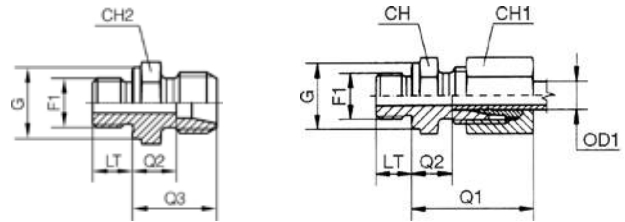

Item Code Body Only	Item Code Complete	Head 1 / Head 2	OD1	F1	Q1	Q2	Q3	CH	CH1	LT	G
		mm									
1205809	1243830	-0610	6	M10X1.0	23,0	8,5	15,5	14,0	14,0	8,0	14,0
1205684	1243831	-0812	8	M12X1.5	25,0	10,0	17,0	17,0	17,0	12,0	17,0
1205556	1243832	-1014	10	M14X1.5	26,0	11,0	18,0	19,0	19,0	12,0	19,0
1203520	1243833	-1216	12	M16X1.5	27,0	12,5	19,5	22,0	22,0	12,0	21,0
1205557	1243834	-1518	15	M18X1.5	29,0	14,0	20,5	24,0	27,0	14,0	23,0
1206006	1243835	-1822	18	M22X1.5	31,0	14,5	22,0	27,0	32,0	14,0	27,0
1205812	1243836	-2226	22	M26X1.5	33,0	16,5	24,0	32,0	36,0	16,0	31,0
1206534	1243837	-2833	28	M33X2.0	34,0	17,5	25,0	41,0	41,0	18,0	39,0
1208162	1243838	-3542	35	M42X2	39,0	17,5	28,0	50,0	50,0	20,0	49,0
1207814	1243839	-4248	42	M48X2.0	42,0	19,0	30,0	55,0	60,0	22,0	55,0

// R1A12M150M

**Straight connector DIN 24° Male -
Metric cylindric Male - Heavy series**

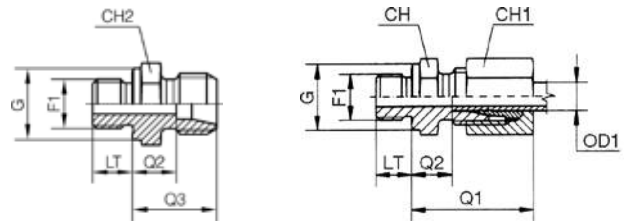

Item Code Body Only	Item Code Complete	Head 1 / Head 2	OD1	F1	Q1	Q2	Q3	CH	CH1	LT	G
		mm									
1206225	1244185	-0612	6	M12X1.5	28,0	13,0	20,0	17,0	17,0	12,0	17,0
1206226	1244186	-0814	8	M14X1.5	30,0	15,0	22,0	19,0	19,0	12,0	19,0
1205971	1244187	-1016	10	M16X1.5	31,0	15,0	22,5	22,0	22,0	12,0	21,0
1205813	1244188	-1218	12	M18X1.5	33,0	17,0	24,5	24,0	24,0	12,0	23,0
1205814	1244189	-1420	14	M20X1.5	37,0	19,0	27,0	27,0	27,0	14,0	25,0
1205815	1244190	-1622	16	M22X1.5	37,0	18,5	27,0	27,0	30,0	14,0	27,0
1205816	1244191	-2027	20	M27X2	42,0	20,5	31,0	32,0	36,0	16,0	32,0
1205817	1244192	-2533	25	M33X2.0	47,0	23,0	35,0	41,0	46,0	18,0	39,0
1211293	1244193	-3042	30	M42X2	50,0	23,5	37,0	50,0	50,0	20,0	49,0
1211294	1244194	-3848	38	M48X2.0	57,0	26,0	42,0	55,0	60,0	22,0	55,0

Dimensions shown may be changed without prior notice

// R1A11M950M

90° elbow connector DIN 24° Male - Metric cylindric Male - Light series

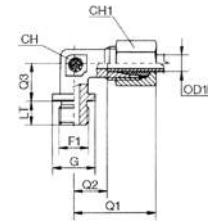
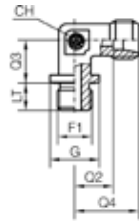

Item Code Body Only	Item Code Complete	Head 1 / Head 2	OD1	F1	Q1	Q2	Q3	Q4	CH	CH1	LT	G
		mm										
1211163	1243878	-2226	22	M26X1.5	44,0	27,5	26,0	35,0	27,0	36,0	16,0	31,0
1211164	1243879	-2833	28	M33X2.0	47,0	30,5	30,0	38,0	36,0	41,0	18,0	39,0
1211165	1243880	-3542	35	M42X2	56,0	34,5	34,0	45,0	41,0	50,0	20,0	49,0
1211166	1243881	-4248	42	M48X2.0	63,0	40,0	39,0	51,0	50,0	60,0	22,0	55,0

// R1A12M950M

90° elbow connector DIN 24° Male - Metric cylindric Male - Heavy series

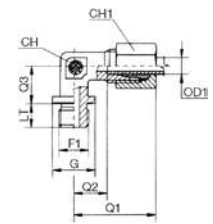
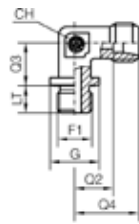

Item Code Body Only	Item Code Complete	Head 1 / Head 2	OD1	F1	Q1	Q2	Q3	Q4	CH	CH1	LT	G
		mm										
1211320	1244242	-2027	20	M27X2	48,0	26,5	26,0	37,0	27,0	36,0	16,0	32,0
1211321	1244243	-2533	25	M33X2.0	54,0	31,0	30,0	42,0	36,0	46,0	18,0	39,0
1211322	1244244	-3042	30	M42X2	62,0	35,5	34,0	49,0	41,0	50,0	20,0	49,0
1211323	1244245	-3848	38	M48X2.0	72,0	41,0	39,0	57,0	50,0	60,0	22,0	55,0

// R1A11M452Q

**45° adjustable elbow connector DIN
24° Male - Metric Male with O-Ring
and retaining ring - Light series**



Item Code Body Only	Item Code Complete	Head 1 / Head 2	OD1	F1	Q1	Q2	Q3	Q4	CH	CH1	LN	LT	G
		mm											
1244877	1244949	-0610	6	M10X1.0	29,0	14,0	20,0	21,0	14,0	14,0	14,0	7,5	15,0
1244878	1244950	-0812	8	M12X1.5	31,0	16,0	22,5	23,0	14,0	17,0	17,0	9,5	18,0
1239701	1244951	-1014	10	M14X1.5	32,0	17,0	25,5	24,0	19,0	19,0	19,0	9,5	20,0
1244879	1244952	-1216	12	M16X1.5	34,0	19,0	26,0	26,0	19,0	22,0	22,0	10,0	23,0
1244880	1244953	-1518	15	M18X1.5	36,0	21,0	30,0	28,0	22,0	27,0	24,0	11,0	25,0
1244881	1244954	-1822	18	M22X1.5	40,0	24,0	34,0	31,5	27,0	32,0	27,0	11,0	28,0
1244882	1244955	-2227	22	M27X2	44,0	28,0	36,0	35,5	33,0	36,0	32,0	13,5	33,0
1244883	1244956	-2833	28	M33X2.0	47,0	31,0	40,5	38,5	41,0	41,0	41,0	13,5	41,0
1244884	1244957	-3542	35	M42X2	59,0	38,0	48,5	48,5	48,0	50,0	50,0	13,5	51,0
1244885	1244958	-4248	42	M48X2.0	61,0	38,0	50,0	49,0	48,0	60,0	55,0	15,0	56,0

// R1A12M452Q

**45° adjustable elbow connector DIN
24° Male - Metric Male with O-Ring
and retaining ring - Heavy series**



Item Code Body Only	Item Code Complete	Head 1 / Head 2	OD1	F1	Q1	Q2	Q3	Q4	CH	CH1	LN	LT	G
		mm											
1244903	1245017	-0612	6	M12X1.5	30,5	15,5	23,5	22,5	14,0	17,0	17,0	9,5	18,0
1244904	1245018	-0814	8	M14X1.5	33,0	18,0	26,5	25,0	19,0	19,0	19,0	9,5	20,0
1237052	1245019	-1016	10	M16X1.5	34,0	18,0	27,0	25,5	19,0	22,0	22,0	11,0	23,0
1244905	1245020	-1218	12	M18X1.5	38,0	22,0	30,5	29,5	22,0	24,0	24,0	12,5	25,0
1244906	1245021	-1622	16	M22X1.5	43,0	25,0	37,0	33,5	27,0	30,0	27,0	13,0	28,0
1237053	1245022	-2027	20	M27X2	49,0	28,0	39,5	38,5	33,0	36,0	32,0	14,0	33,0
1244907	1245023	-2533	25	M33X2.0	54,5	30,5	43,0	42,5	41,0	46,0	41,0	14,0	41,0
1244908	1245024	-3042	30	M42X2	62,0	36,0	52,0	49,5	48,0	50,0	50,0	16,0	51,0
1244909	1245025	-3848	38	M48X2.0	65,0	34,0	51,0	50,0	48,0	60,0	55,0	18,0	56,0

Dimensions shown may be changed without prior notice

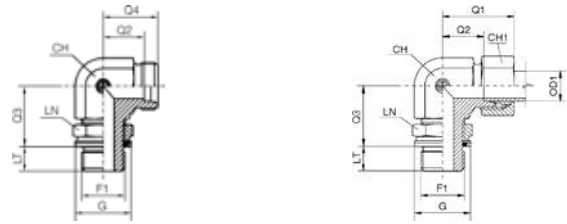
// R1A11M952Q**90° adjustable elbow connector DIN
24° Male - Metric Male with O-Ring
and retaining ring - Light series**

Item Code Body Only	Item Code Complete	Head 1 / Head 2	OD1	F1	Q1	Q2	Q3	Q4	CH	CH1	LN	LT	G
		mm											
1242471	1243882	-0610	6	M10X1.0	29,0	14,0	20,0	21,0	14,0	14,0	14,0	7,5	15,0
1231361	1243883	-0812	8	M12X1.5	31,0	16,0	22,5	23,0	14,0	17,0	17,0	9,5	18,0
1231362	1243884	-1014	10	M14X1.5	32,0	17,0	25,5	24,0	19,0	19,0	19,0	9,5	20,0
1242472	1243885	-1216	12	M16X1.5	34,0	19,0	26,0	26,0	19,0	22,0	22,0	10,0	23,0
1231363	1243886	-1518	15	M18X1.5	36,0	21,0	30,0	28,0	22,0	27,0	24,0	11,0	25,0
1242473	1243887	-1822	18	M22X1.5	40,0	24,0	34,0	31,5	27,0	32,0	27,0	11,0	28,0
1237041	1243888	-2227	22	M27X2	44,0	28,0	36,0	35,5	33,0	36,0	32,0	13,5	33,0
1231364	1243889	-2833	28	M33X2.0	47,0	31,0	40,5	38,5	41,0	41,0	41,0	13,5	41,0
1231365	1243890	-3542	35	M42X2	59,0	38,0	48,5	48,5	48,0	50,0	50,0	13,5	51,0
1242474	1243891	-4248	42	M48X2.0	61,0	38,0	50,0	49,0	48,0	60,0	55,0	15,0	56,0

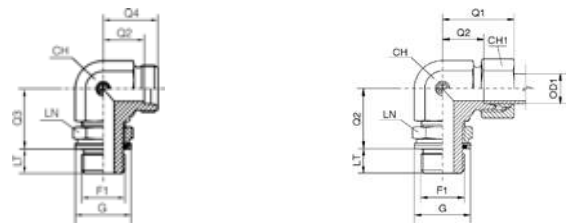
// R1A12M952Q**90° adjustable elbow connector DIN
24° Male - Metric Male with O-Ring
and retaining ring - Heavy series**

Item Code Body Only	Item Code Complete	Head 1 / Head 2	OD1	F1	Q1	Q2	Q3	Q4	CH	CH1	LN	LT	G
		mm											
1231379	1244246	-0612	6	M12X1.5	30,5	15,5	23,5	22,5	14,0	17,0	17,0	9,5	18,0
1216243	1244247	-0814	8	M14X1.5	33,0	18,0	26,5	25,0	19,0	19,0	19,0	9,5	20,0
1242475	1244248	-1016	10	M16X1.5	34,0	18,0	27,0	25,5	19,0	22,0	22,0	11,0	23,0
1242476	1244249	-1218	12	M18X1.5	38,0	22,0	30,5	29,5	22,0	24,0	24,0	12,5	25,0
1242477	1244250	-1622	16	M22X1.5	43,0	25,0	37,0	33,5	27,0	30,0	27,0	13,0	28,0
1211329	1244251	-2027	20	M27X2	49,0	28,0	39,5	38,5	33,0	36,0	32,0	14,0	33,0
1242478	1244252	-2533	25	M33X2.0	54,5	30,5	43,0	42,5	41,0	46,0	41,0	14,0	41,0
1242479	1244253	-3042	30	M42X2	62,0	36,0	52,0	49,5	48,0	50,0	50,0	16,0	51,0
1242480	1244254	-3848	38	M48X2.0	65,0	34,0	51,0	50,0	48,0	60,0	55,0	18,0	56,0

// R1A11MT52Q

Branch Tee adjustable elbow connector DIN 24° Male - Metric Male with O-Ring and retaining ring - Light series

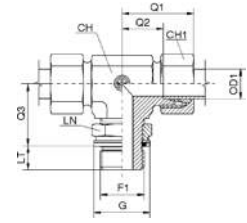
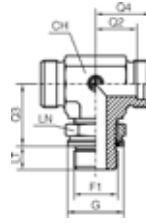

Item Code Body Only	Item Code Complete	Head 1 / Head 2	OD1	F1	Q1	Q2	Q3	Q4	CH	CH1	LN	LT	G
		mm											
1242481	1243995	-0610	6	M12X1.5	29,0	14,0	20,0	21,0	14,0	14,0	14,0	7,5	15,0
1242482	1243996	-0812	8	M14X1.5	31,0	16,0	22,5	23,0	14,0	17,0	17,0	9,5	18,0
1242483	1243997	-1014	10	M16X1.5	32,0	17,0	25,5	24,0	19,0	19,0	19,0	9,5	20,0
1242484	1243998	-1216	12	M18X1.5	34,0	19,0	26,0	26,0	19,0	22,0	22,0	10,0	23,0
1242485	1243999	-1518	15	M22X1.5	36,0	21,0	30,0	28,0	22,0	27,0	24,0	11,0	25,0
1242486	1244000	-1822	18	M26X1.5	40,0	24,0	34,0	31,5	27,0	32,0	27,0	11,0	28,0
1242487	1244001	-2227	22	M30X2	44,0	28,0	36,0	35,5	33,0	36,0	32,0	13,5	33,0
1242488	1244002	-2833	28	M36X2	47,0	31,0	40,5	38,5	41,0	41,0	41,0	13,5	41,0
1242489	1244003	-3542	35	M45X2	59,0	38,0	48,5	48,5	48,0	50,0	50,0	13,5	51,0
1237043	1244004	-4248	42	M52X2	61,0	38,0	50,0	49,0	48,0	60,0	55,0	15,0	56,0

// R1A12MT52Q

Branch Tee adjustable elbow connector DIN 24° Male - Metric Male with O-Ring and retaining ring - Heavy series

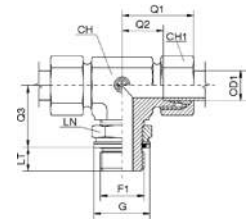
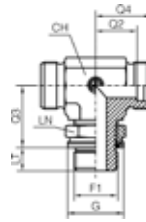

Item Code Body Only	Item Code Complete	Head 1 / Head 2	OD1	F1	Q1	Q2	Q3	Q4	CH	CH1	LN	LT	G
		mm											
1242490	1244370	-0612	6	M14X1.5	30,5	15,5	23,5	22,5	14,0	17,0	17,0	9,5	18,0
1242491	1244371	-0814	8	M16X1.5	33,0	18,0	26,5	25,0	19,0	19,0	19,0	9,5	20,0
1242492	1244372	-1016	10	M18X1.5	34,0	18,0	27,0	25,5	19,0	22,0	22,0	11,0	23,0
1242493	1244373	-1218	12	M20X1.5	38,0	22,0	30,5	29,5	22,0	24,0	24,0	12,5	25,0
1242494	1244374	-1622	16	M24X1.5	43,0	25,0	37,0	33,5	27,0	30,0	27,0	13,0	28,0
1242495	1244375	-2027	20	M30X2	49,0	28,0	39,5	38,5	33,0	36,0	32,0	14,0	33,0
1242496	1244376	-2533	25	M36X2	54,5	30,5	43,0	42,5	41,0	46,0	41,0	14,0	41,0
1242497	1244377	-3042	30	M42X2	62,0	36,0	52,0	49,5	48,0	50,0	50,0	16,0	51,0
1242498	1244378	-3848	38	M52X2	65,0	34,0	51,0	50,0	48,0	60,0	55,0	18,0	56,0

Dimensions shown may be changed without prior notice

// R1A11ML52Q

**Run Tee adjustable elbow connector
DIN 24° Male - Metric Male with
O-Ring and retaining ring - Light
series**

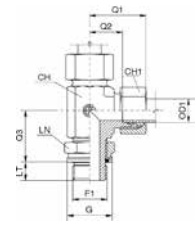
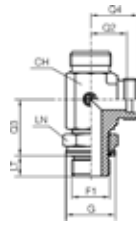

Item Code Body Only	Item Code Complete	Head 1 / Head 2	OD1	F1	Q1	Q2	Q3	Q4	CH	CH1	LN	LT	G
		mm											
1242499	1243954	-0610	6	M10X1.0	29,0	14,0	20,0	21,0	14,0	14,0	14,0	7,5	15,0
1242500	1243955	-0812	8	M12X1.5	31,0	16,0	22,5	23,0	14,0	17,0	17,0	9,5	18,0
1242501	1243956	-1014	10	M14X1.5	32,0	17,0	25,5	24,0	19,0	19,0	19,0	9,5	20,0
1242502	1243957	-1216	12	M16X1.5	34,0	19,0	26,0	26,0	19,0	22,0	22,0	10,0	23,0
1242503	1243958	-1518	15	M18X1.5	36,0	21,0	30,0	28,0	22,0	27,0	24,0	11,0	25,0
1242504	1243959	-1822	18	M22X1.5	40,0	24,0	34,0	31,5	27,0	32,0	27,0	11,0	28,0
1242505	1243960	-2227	22	M27X2	44,0	28,0	36,0	35,5	33,0	36,0	32,0	13,5	33,0
1242506	1243961	-2833	28	M33X2.0	47,0	31,0	40,5	38,5	41,0	41,0	41,0	13,5	41,0
1242507	1243962	-3542	35	M42X2	59,0	38,0	48,5	48,5	48,0	50,0	50,0	13,5	51,0
1242508	1243963	-4248	42	M48X2.0	61,0	38,0	50,0	49,0	48,0	60,0	55,0	15,0	56,0

// R1A12ML52Q

**Run Tee adjustable elbow connector
DIN 24° Male - Metric Male with
O-Ring and retaining ring - Heavy
series**

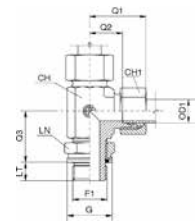
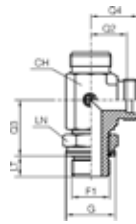

Item Code Body Only	Item Code Complete	Head 1 / Head 2	OD1	F1	Q1	Q2	Q3	Q4	CH	CH1	LN	LT	G
		mm											
1242509	1244322	-0612	6	M12X1.5	30,5	15,5	23,5	22,5	14,0	17,0	17,0	9,5	18,0
1242510	1244323	-0814	8	M14X1.5	33,0	18,0	26,5	25,0	19,0	19,0	19,0	9,5	20,0
1242511	1244324	-1016	10	M16X1.5	34,0	18,0	27,0	25,5	19,0	22,0	22,0	11,0	23,0
1242512	1244325	-1218	12	M18X1.5	38,0	22,0	30,5	29,5	22,0	24,0	24,0	12,5	25,0
1242513	1244326	-1622	16	M22X1.5	43,0	25,0	37,0	33,5	27,0	30,0	27,0	13,0	28,0
1242514	1244327	-2027	20	M27X2	49,0	28,0	39,5	38,5	33,0	36,0	32,0	14,0	33,0
1242515	1244328	-2533	25	M33X2.0	54,5	30,5	43,0	45,5	41,0	46,0	41,0	14,0	41,0
1242516	1244329	-3042	30	M42X2	62,0	36,0	52,0	49,5	48,0	50,0	50,0	16,0	51,0
1242517	1244330	-3848	38	M48X2.0	65,0	34,0	51,0	50,0	48,0	60,0	55,0	18,0	56,0

// R1A11M152I

**Straight connector DIN 24° Male -
Metric cylindric Male with elastomer
- Light series**

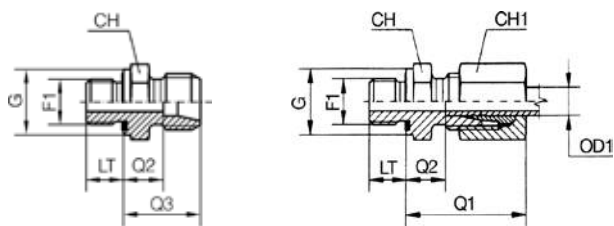

Item Code Body Only	Item Code Complete	Head 1 / Head 2	OD1 mm	F1	Q1 mm	Q2 mm	Q3 mm	CH mm	CH1 mm	LT mm	G mm
		mm									
1206135	1241558	-0610	6	M10X1.0	23,0	8,5	15,5	14,0	14,0	8,0	14,0
1206136	1241700	-0812	8	M12X1.5	25,0	10,0	17,0	17,0	17,0	12,0	17,0
1206137	1243840	-1014	10	M14X1.5	26,0	11,0	18,0	19,0	19,0	12,0	19,0
1206163	1243841	-1216	12	M16X1.5	27,0	12,5	19,5	22,0	22,0	12,0	22,0
1206138	1243842	-1518	15	M18X1.5	29,0	14,0	20,5	24,0	27,0	14,0	24,0
1206085	1243843	-1822	18	M22X1.5	31,0	14,5	22,0	27,0	32,0	14,0	27,0
1206284	1243844	-2226	22	M26X1.5	33,0	16,5	24,0	32,0	36,0	16,0	32,0
1207004	1243845	-2833	28	M33X2.0	34,0	17,5	25,0	41,0	41,0	18,0	40,0
1207005	1243846	-3542	35	M42X2	39,0	17,5	28,0	50,0	50,0	20,0	50,0

// R1A12M152I

**Straight connector DIN 24° Male -
Metric cylindric Male with elastomer
- Heavy series**

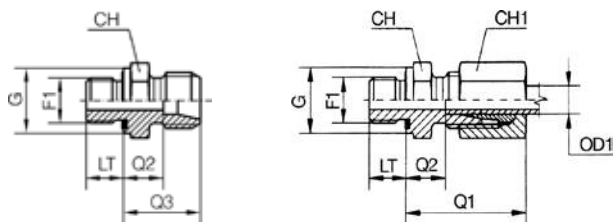

Item Code Body Only	Item Code Complete	Head 1 / Head 2	OD1 mm	F1	Q1 mm	Q2 mm	Q3 mm	CH mm	CH1 mm	LT mm	G mm
		mm									
1206285	1244195	-0612	6	M12X1.5	28,0	13,0	20,0	17,0	17,0	12,0	17,0
1207024	1244196	-0814	8	M14X1.5	30,0	15,0	22,0	19,0	19,0	12,0	19,0
1206286	1244197	-1016	10	M16X1.5	31,0	15,0	22,5	22,0	22,0	12,0	22,0
1206162	1244198	-1218	12	M18X1.5	33,0	17,0	24,5	24,0	24,0	12,0	24,0
1211295	1244199	-1420	14	M20X1.5	37,0	19,0	27,0	27,0	27,0	14,0	26,0
1206287	1244200	-1622	16	M22X1.5	37,0	18,5	27,0	27,0	30,0	14,0	27,0
1241127	1244201	-2027	20	M27X2	42,0	20,5	31,0	32,0	36,0	16,0	32,0
1206061	1244202	-2533	25	M33X2.0	47,0	23,0	35,0	41,0	46,0	18,0	40,0
1211296	1244203	-3042	30	M42X2	50,0	23,5	37,0	50,0	50,0	20,0	50,0
1208081	1244204	-3848	38	M48X2.0	57,0	26,0	42,0	55,0	60,0	22,0	55,0

Dimensions shown may be changed without prior notice

// R1A113152I

Straight connector DIN 24° Female pre-assembled - Metric cylindric Male with elastomer - Light series

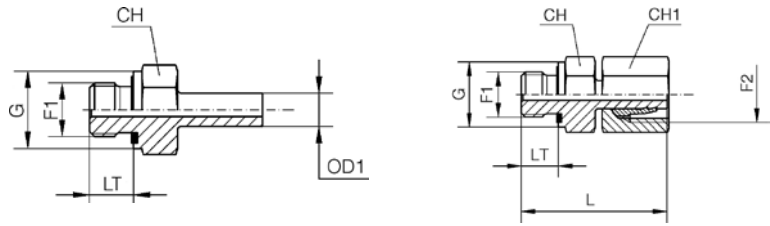

Item Code Body Only	Item Code Complete	Head 1 / Head 2	OD1	F1	F2	LT	CH	CH1	G	L
		mm	mm							
1206979	1243698	-0610	6	M12X1.5	M10X1.0	8,0	14,0	14,0	14,0	32,5
1206980	1243699	-0812	8	M14X1.5	M12X1.5	12,0	17,0	17,0	17,0	38,5
1206981	1243700	-1014	10	M16X1.5	M14X1.5	12,0	19,0	19,0	19,0	39,0
1206288	1243701	-1216	12	M18X1.5	M16X1.5	12,0	22,0	22,0	22,0	42,5
1206067	1243702	-1518	15	M22X1.5	M18X1.5	12,0	24,0	27,0	24,0	43,5
1206982	1243703	-1822	18	M26X1.5	M22X1.5	14,0	27,0	32,0	27,0	45,5
1206983	1243704	-2226	22	M30X2	M26X1.5	16,0	32,0	36,0	32,0	48,5
1206984	1243705	-2833	28	M36X2	M33X2.0	18,0	41,0	41,0	40,0	53,5
1206985	1243706	-3542	35	M45X2	M42X2	20,0	50,0	50,0	50,0	62,5
1206986	1243707	-4248	42	M52X2	M48X2.0	22,0	55,0	60,0	55,0	68,5

// R1A123152I

Straight connector DIN 24° Female pre-assembled - Metric cylindric Male with elastomer - Heavy series

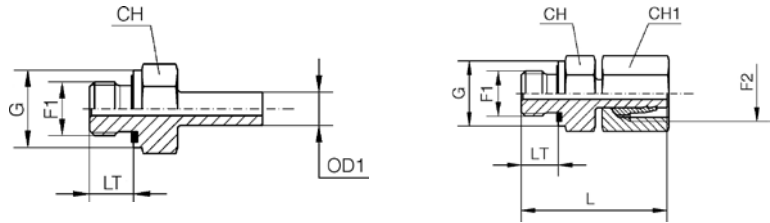

Item Code Body Only	Item Code Complete	Head 1 / Head 2	OD1	F1	F2	LT	CH	CH1	G	L
		mm	mm							
1207011	1244037	-0612	6	M14X1.5	M12X1.5	12,0	17,0	17,0	17,0	39,0
1207012	1244038	-0814	8	M16X1.5	M14X1.5	12,0	19,0	19,0	19,0	41,5
1207013	1244039	-1016	10	M18X1.5	M16X1.5	12,0	22,0	22,0	22,0	44,0
1207014	1244040	-1218	12	M20X1.5	M18X1.5	12,0	24,0	24,0	24,0	46,0
1207015	1244041	-1420	14	M22X1.5	M20X1.5	14,0	27,0	27,0	26,0	50,5
1207016	1244042	-1622	16	M24X1.5	M22X1.5	14,0	27,0	30,0	27,0	51,0
1207017	1244043	-2027	20	M30X2	M27X2	16,0	32,0	36,0	32,0	59,0
1207018	1244044	-2533	25	M36X2	M33X2.0	18,0	41,0	46,0	40,0	66,0
1207019	1244045	-3042	30	M42X2	M42X2	20,0	50,0	50,0	50,0	71,0
1207020	1244046	-3848	38	M52X2	M48X2.0	22,0	55,0	60,0	55,0	82,0

// R1A152152I

Straight connector DIN 24° Female with O-Ring - Metric cylindric Male with elastomer - Light series

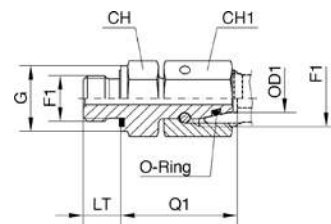

Item Code	Head 1 / Head 2	OD1	F1	F2	Q1	LT	CH	CH1	G
	mm								
1211387	-0610	6	M12X1.5	M10X1.0	24,5	8,0	14,0	14,0	14,0
1211388	-0812	8	M14X1.5	M12X1.5	26,5	12,0	17,0	17,0	17,0
1211389	-1014	10	M16X1.5	M14X1.5	27,5	12,0	19,0	19,0	19,0
1211390	-1216	12	M18X1.5	M16X1.5	30,5	12,0	22,0	22,0	22,0
1211391	-1518	15	M22X1.5	M18X1.5	31,5	12,0	24,0	27,0	24,0
1208086	-1822	18	M26X1.5	M22X1.5	31,5	14,0	27,0	32,0	27,0
1211392	-2226	22	M30X2	M26X1.5	32,5	16,0	32,0	36,0	32,0
1211393	-2833	28	M36X2	M33X2.0	35,0	18,0	41,0	41,0	40,0
1211394	-3542	35	M45X2	M42X2	42,5	20,0	50,0	50,0	50,0
1211395	-4248	42	M52X2	M48X2.0	46,5	22,0	55,0	60,0	55,0

// R1A162152I

Straight connector DIN 24° Female with O-Ring - Metric cylindric Male with elastomer - Heavy series

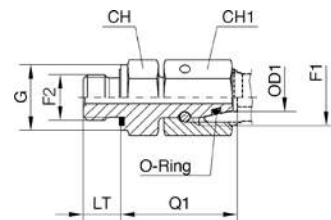

Item Code	Head 1 / Head 2	OD1	F1	F2	Q1	LT	CH	CH1	G
	mm								
1211450	-0612	6	M14X1.5	M12X1.5	27,0	12,0	17,0	17,0	17,0
1211451	-0814	8	M16X1.5	M14X1.5	29,5	12,0	19,0	19,0	19,0
1211452	-1016	10	M18X1.5	M16X1.5	32,0	12,0	22,0	22,0	22,0
1208171	-1218	12	M20X1.5	M18X1.5	34,0	12,0	24,0	24,0	24,0
1208172	-1420	14	M22X1.5	M20X1.5	36,5	14,0	27,0	27,0	26,0
1211453	-1622	16	M24X1.5	M22X1.5	37,0	14,0	27,0	30,0	27,0
1211454	-2027	20	M30X2	M27X2	43,0	16,0	32,0	36,0	32,0
1211455	-2533	25	M36X2	M33X2.0	48,0	18,0	41,0	46,0	40,0
1208178	-3042	30	M42X2	M42X2	51,0	20,0	50,0	50,0	50,0
1208181	-3848	38	M52X2	M48X2.0	60,0	22,0	55,0	60,0	55,0

Dimensions shown may be changed without prior notice

// R1A11M962M

90° elbow connector DIN 24° Male - Metric conic Male - Light series

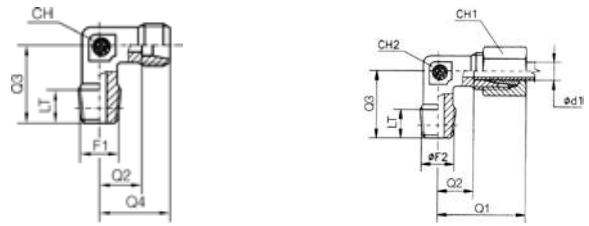

Item Code	Head 1 / Head 2	OD1 mm	F2	Q1	Q2	Q3	Q4	CH	CH1	LT
	mm			mm	mm	mm	mm	mm	mm	mm
1206141	-0610	6	M10X1.0	27,0	12,0	20,0	19,0	12,0	14,0	8,0
1206353	-0812	8	M12X1.5	29,0	14,0	26,0	21,0	12,0	17,0	12,0
1205818	-1014	10	M14X1.5	30,0	15,0	27,0	22,0	14,0	19,0	12,0
1205819	-1216	12	M16X1.5	32,0	17,0	28,0	24,0	17,0	22,0	12,0
1206229	-1518	15	M18X1.5	36,0	21,0	34,0	28,0	19,0	27,0	14,0
1208106	-1822	18	M22X1.5	40,0	23,5	36,0	31,0	24,0	32,0	14,0

// R1A12M962M

90° elbow connector DIN 24° Male - Metric conic Male - Heavy series

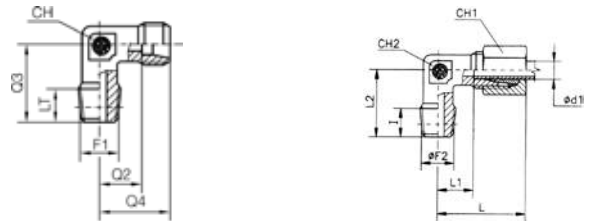

Item Code	Head 1 / Head 2	OD1 mm	F2	Q1	Q2	Q3	Q4	CH	CH1	LT
	mm			mm	mm	mm	mm	mm	mm	mm
1211333	-0612	6	M12X1.5	31,0	16,0	26,0	23,0	12,0	17,0	12,0
1211334	-0814	8	M14X1.5	32,0	17,0	27,0	24,0	14,0	19,0	12,0
1206142	-1016	10	M16X1.5	34,0	17,5	28,0	25,0	17,0	22,0	12,0
1206143	-1218	12	M18X1.5	38,0	21,5	31,0	29,0	17,0	24,0	12,0
1211335	-1420	14	M20X1.5	40,0	22,0	32,0	30,0	19,0	27,0	14,0
1206720	-1622	16	M22X1.5	43,0	24,5	32,0	33,0	24,0	30,0	14,0

// R1A11ME505

**Banjo adjustable - Type A - Metric
cylindric DIN 24° - Light series**

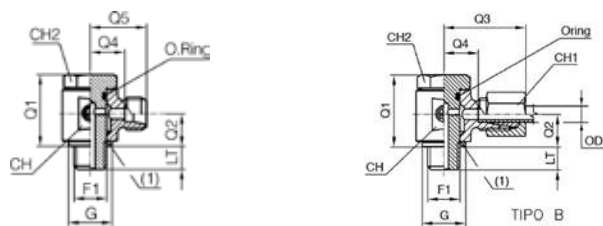

Item Code Body Only	Item Code Complete	Head 1 / Head 2	OD1	F1	Q1	Q2	Q3	Q4	Q5	LT	CH	CH1	CH2	G
		mm												
1205882	1243914	-0610	6	M10X1.0	27,0	12,5	29,0	13,0	20,0	8,0	19,0	14,0	17,0	15,0
1206274	1243915	-0812	8	M12X1.5	30,5	15,0	30,5	14,5	21,5	12,0	22,0	17,0	19,0	17,0
1244461	1231370	-1014	10	M14X1.5	30,5	15,0	32,0	15,5	22,5	12,0	22,0	19,0	19,0	18,0
1206581	1243916	-1216	12	M16X1.5	38,5	19,0	36,0	19,5	26,5	12,0	30,0	22,0	24,0	22,0
1206577	1243917	-1518	15	M18X1.5	44,5	21,5	39,0	22,5	29,0	14,0	36,0	27,0	24,0	22,0
1206580	1243918	-1822	18	M22X1.5	48,0	23,0	40,0	22,0	29,5	14,0	36,0	32,0	27,0	26,0
1206579	1243919	-2226	22	M26X1.5	56,0	26,0	47,0	28,0	35,5	16,0	41,0	36,0	32,0	32,0

// R1A12ME505

**Banjo adjustable - Type A - Metric
cylindric DIN 24° - Heavy series**

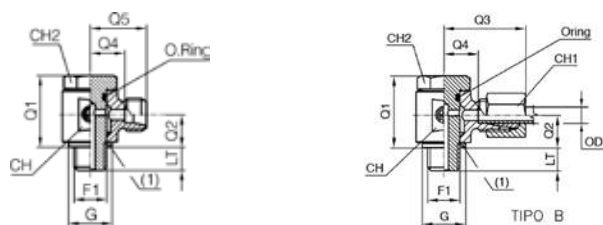

Item Code Body Only	Item Code Complete	Head 1 / Head 2	OD1	F1	Q1	Q2	Q3	Q4	Q5	LT	CH	CH1	CH2	G
		mm												
1207056	1244276	-0612	6	M12X1.5	30,5	15,0	33,0	16,5	23,5	12,0	22,0	17,0	19,0	17,0
1207057	1244277	-0814	8	M14X1.5	30,5	15,0	32,5	16,5	23,5	12,0	22,0	19,0	19,0	18,0
1208098	1244278	-1016	10	M16X1.5	38,5	19,0	38,0	20,0	27,5	12,0	30,0	22,0	24,0	22,0
1206456	1244279	-1218	12	M18X1.5	37,5	18,0	38,0	20,0	27,5	12,0	30,0	24,0	24,0	22,0
1208099	1244280	-1420	14	M20X1.5	48,0	23,0	42,5	23,5	31,5	14,0	36,0	27,0	27,0	26,0
1206578	1244281	-1622	16	M22X1.5	48,0	23,0	43,0	23,0	31,5	14,0	36,0	30,0	27,0	26,0
1211301	1244282	-2027	20	M27X2	56,0	26,0	51,5	27,0	37,5	16,0	41,0	36,0	32,0	32,0

Dimensions shown may be changed without prior notice

// R1A11ME50M

Banjo adjustable - Type B - Metric
cylindric DIN 24° - Light series

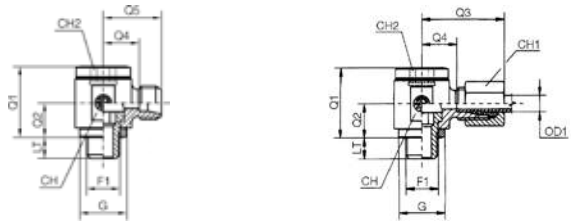

Item Code Body Only	Item Code Complete	Head 1 / Head 2	OD1	F1	Q1	Q2	Q3	Q4	Q5	LT	CH	CH1	CH2	G
		mm			mm	mm	mm	mm	mm					
1211010	1243920	-0610	6	M10X1.0	24,0	12,0	27,0	12,5	19,5	8,0	19,0	14,0	6,0	14,0
1206153	1243921	-0812	8	M12X1.5	30,0	15,0	29,0	14,5	21,5	12,0	22,0	17,0	6,0	17,0
1206275	1243922	-1014	10	M14X1.5	30,0	16,0	30,0	15,5	23,0	12,0	22,0	19,0	8,0	19,0
1206276	1243923	-1216	12	M16X1.5	37,0	18,0	33,0	18,0	25,5	12,0	27,0	22,0	10,0	21,0
1206154	1243924	-1518	15	M18X1.5	40,0	20,0	36,0	21,0	28,0	12,0	30,0	27,0	12,0	23,0
1207055	1243925	-1822	18	M22X1.5	46,0	23,0	38,0	21,5	29,0	14,0	36,0	32,0	14,0	27,0
1211011	1243926	-2226	22	M26X1.5	51,0	25,0	42,0	26,0	35,0	16,0	41,0	36,0	17,0	31,0
1211012	1243927	-2833	28	M33X2.0	64,0	32,0	48,0	31,5	39,0	18,0	50,0	41,0	22,0	39,0
1211013	1243928	-3542	35	M42X2	76,0	37,0	57,0	35,5	46,0	20,0	60,0	50,0	27,0	49,0

// R1A12ME50M

Banjo adjustable - Type B - Metric
cylindric DIN 24° - Heavy series

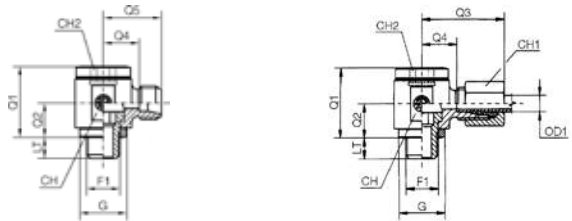

Item Code Body Only	Item Code Complete	Head 1 / Head 2	OD1	F1	Q1	Q2	Q3	Q4	Q5	LT	CH	CH1	CH2	G
		mm			mm	mm	mm	mm	mm					
1206895	1244283	-0612	6	M12X1.5	30,0	15,0	31,0	16,5	23,5	12,0	22,0	17,0	6,0	17,0
1207058	1244284	-0814	8	M14X1.5	30,0	16,0	31,0	16,5	23,5	12,0	22,0	19,0	8,0	19,0
1206155	1244285	-1016	10	M16X1.5	37,0	18,0	35,0	18,5	26,0	12,0	27,0	22,0	10,0	21,0
1206156	1244286	-1218	12	M18X1.5	41,0	20,0	37,0	20,5	28,0	12,0	30,0	24,0	12,0	23,0
1206844	1244287	-1420	14	M20X1.5	42,0	21,0	41,0	23,0	31,0	14,0	32,0	27,0	12,0	25,0
1208221	1244288	-1622	16	M22X1.5	46,0	23,0	41,0	22,5	31,0	14,0	36,0	30,0	14,0	27,0
1207465	1244289	-2027	20	M27X2	58,0	28,0	49,0	27,5	38,0	16,0	46,0	36,0	17,0	32,0
1211200	1244290	-2533	25	M33X2.0	64,0	32,0	55,0	31,0	43,0	18,0	50,0	46,0	22,0	39,0
1208222	1244291	-3042	30	M42X2	76,0	37,0	63,0	36,5	50,0	20,0	60,0	50,0	27,0	49,0
1206157	1244292	-3848	38	M48X2.0	85,0	42,0	72,0	41,0	58,5	22,0	70,0	60,0	32,0	55,0

// BSPP

// R1A11M106M

Straight connector DIN 24° Male - BSPP cylindric flat Male - Light series

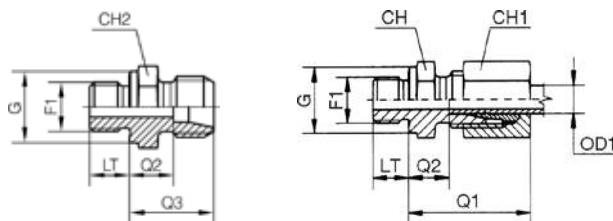

Item Code Body Only	Item Code Complete	Head 1 / Head 2	OD1	F1	Q1	Q2	Q3	CH	CH1	LT	G
		mm									
1205740	1243731	-0602	6	1/8-28	23,0	8,5	15,5	14,0	14,0	8,0	14,0
1204273	1243732	-0604	6	1/4-19	25,0	10,0	17,0	19,0	14,0	12,0	18,0
1206930	1243733	-0606	6	3/8-19	26,0	11,5	18,5	22,0	14,0	12,0	22,0
1205528	1242345	-0804	8	1/4-19	25,0	10,0	17,0	19,0	17,0	12,0	18,0
1204274	1243734	-0806	8	3/8-19	26,0	11,5	18,5	22,0	17,0	12,0	22,0
1206597	1243735	-0808	8	1/2-14	27,0	12,0	19,0	27,0	17,0	14,0	26,0
1204262	1243736	-1004	10	1/4-19	26,0	11,0	18,0	19,0	19,0	12,0	18,0
1204264	1243737	-1006	10	3/8-19	27,0	12,5	19,0	22,0	19,0	12,0	22,0
1204260	1243738	-1008	10	1/2-14	28,0	13,0	20,0	27,0	19,0	14,0	26,0
1205549	1243739	-1204	12	1/4-19	27,0	12,0	19,0	19,0	22,0	12,0	18,0
1204268	1243740	-1206	12	3/8-19	27,0	12,5	19,5	22,0	22,0	12,0	22,0
1204267	1241073	-1208	12	1/2-14	28,0	13,0	20,0	27,0	22,0	14,0	26,0
1204271	1243741	-1506	15	3/8-19	29,0	13,5	20,5	24,0	27,0	12,0	22,0
1204270	1242250	-1508	15	1/2-14	29,0	14,0	21,0	27,0	27,0	14,0	26,0
1205741	1243742	-1808	18	1/2-14	31,0	14,5	22,0	27,0	32,0	14,0	26,0
1205742	1243743	-1812	18	3/4-14	30,0	14,5	22,0	32,0	32,0	16,0	32,0
1205743	1243744	-2212	22	3/4-14	33,0	16,5	24,0	32,0	36,0	16,0	32,0
1205744	1243745	-2816	28	1-11	34,0	17,5	25,0	41,0	41,0	18,0	39,0
1205481	1243746	-3520	35	1 1/4-11	39,0	17,5	28,0	50,0	50,0	20,0	49,0
1206911	1243747	-4224	42	1 1/2-11	42,0	19,0	30,0	55,0	60,0	22,0	55,0

// R1A12M106M

Straight connector DIN 24° Male - BSPP cylindric flat Male - Heavy series

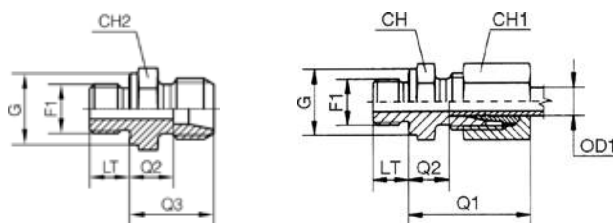

Item Code Body Only	Item Code Complete	Head 1 / Head 2	OD1	F1	Q1	Q2	Q3	CH	CH1	LT	G
		mm									
1206096	1244076	-0604	6	1/4-19	28,0	13,0	20,0	19,0	17,0	12,0	18,0
1205745	1244077	-0804	8	1/4-19	30,0	15,0	22,0	19,0	19,0	12,0	18,0
1205582	1244078	-1006	10	3/8-19	31,0	15,0	22,5	22,0	22,0	12,0	22,0
1205746	1244079	-1206	12	3/8-19	33,0	17,0	24,5	22,0	24,0	12,0	22,0
1206014	1244080	-1208	12	1/2-14	34,0	17,5	25,0	27,0	24,0	14,0	26,0
1205748	1244081	-1408	14	1/2-14	37,0	19,0	27,0	27,0	27,0	14,0	26,0
1205750	1244082	-1608	16	1/2-14	37,0	18,5	27,0	27,0	30,0	14,0	26,0
1205884	1244083	-1612	16	3/4-14	39,0	20,5	29,0	32,0	30,0	16,0	32,0
1205751	1244084	-2012	20	3/4-14	42,0	20,5	31,0	32,0	36,0	16,0	32,0
1205752	1244085	-2516	25	1-11	47,0	23,0	35,0	41,0	46,0	18,0	39,0
1205753	1244086	-3020	30	1 1/4-11	50,0	23,5	37,0	50,0	50,0	20,0	49,0
1205754	1244087	-3824	38	1 1/2-11	57,0	26,0	42,0	55,0	60,0	22,0	55,0

Dimensions shown may be changed without prior notice

// R1A11M106F

**Straight connector DIN 24° Male -
BSPP cylindric Female - Light series**

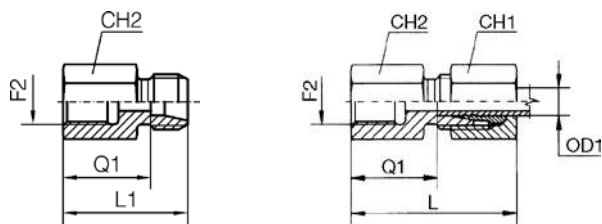

Item Code Body Only	Item Code Complete	Head 1 / Head 2	OD1	F2	Q1	CH	CH1	L	L1
		mm/Dash							
1206267	1240579	-0602	6	1/8-28	19,0	14,0	14,0	34,0	26,0
1205799	1241529	-0804	8	1/4-19	24,0	17,0	19,0	39,0	31,0
1206996	1243718	-0806	8	3/8-19	25,0	17,0	24,0	40,0	32,5
1205800	1240804	-1004	10	1/4-19	25,0	19,0	19,0	40,0	32,0
1205801	1243719	-1206	12	3/8-19	26,0	22,0	24,0	41,0	33,0
1205802	1242104	-1508	15	1/2-14	31,0	27,0	27,0	46,0	38,0
1205803	1243720	-1808	18	1/2-14	30,5	32,0	27,0	47,0	38,0
1205547	1243721	-2212	22	3/4-14	35,5	36,0	36,0	52,0	43,0
1205804	1243722	-2816	28	1-11	38,0	41,0	41,0	55,0	45,5
1206998	1243723	-3520	35	1 1/4-11	41,0	50,0	55,0	63,0	51,5
1208155	1243724	-4224	42	1 1/2-11	42,5	60,0	60,0	65,0	53,5

// R1A12M106F

**Straight connector DIN 24° Male -
BSPP cylindric Female - Heavy series**

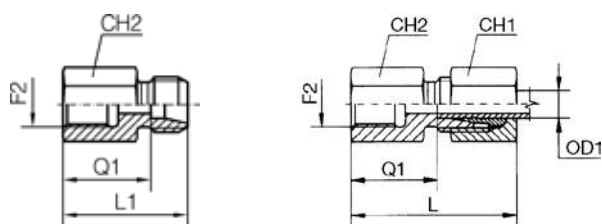

Item Code Body Only	Item Code Complete	Head 1 / Head 2	OD1	F2	Q1	CH	CH1	L	L1
		mm/Dash							
1206364	1244057	-0604	6	1/4-19	26,0	17,0	19,0	41,0	33,0
1205805	1244058	-0804	8	1/4-19	26,0	19,0	19,0	41,0	33,0
1206365	1244059	-1206	12	3/8-19	26,5	24,0	24,0	43,0	34,0
1205806	1244060	-1408	14	1/2-14	32,0	27,0	30,0	50,0	40,0
1205807	1244061	-1608	16	1/2-14	31,5	30,0	30,0	50,0	40,0
1206268	1244062	-2012	20	3/4-14	34,5	36,0	36,0	56,0	45,0
1205808	1244063	-2516	25	1-11	37,5	46,0	41,0	62,0	49,5
1207021	1244064	-3020	30	1 1/4-11	42,0	50,0	55,0	69,0	55,5
1207143	1244065	-3824	38	1 1/2-11	43,5	60,0	60,0	74,0	59,5

// R1A11M106I

**Straight connector DIN 24° Male -
BSPP cylindric Male with elastomer
- Light series**

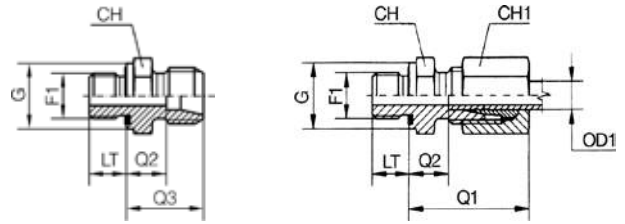

Item Code Body Only	Item Code Complete	Head 1 / Head 2	OD1 mm	F1	Q1 mm	Q2 mm	Q3 mm	CH mm	CH1 mm	LT mm	G mm
		mm									
1206131	1242311	-0602	6	1/8-28	23,0	8,5	15,5	14,0	14,0	8,0	14,0
1205490	1241082	-0804	8	1/4-19	25,0	10,0	17,0	19,0	17,0	12,0	19,0
1205760	1243725	-1004	10	1/4-19	26,0	11,0	18,0	19,0	19,0	12,0	19,0
1205488	1241083	-1206	12	3/8-19	27,0	12,5	19,5	22,0	22,0	12,0	22,0
1205489	1241085	-1508	15	1/2-14	29,0	14,0	21,0	27,0	27,0	14,0	27,0
1206040	1243726	-1808	18	1/2-14	31,0	14,5	22,0	27,0	32,0	14,0	27,0
1205761	1243727	-2212	22	3/4-14	33,0	16,5	24,0	32,0	36,0	16,0	32,0
1206056	1243728	-2816	28	1-11	34,0	17,5	25,0	41,0	41,0	18,0	40,0
1206283	1243729	-3520	35	1 1/4-11	39,0	17,5	28,0	50,0	50,0	20,0	50,0
1206039	1243730	-4224	42	1 1/2-11	42,0	19,0	30,0	55,0	60,0	22,0	55,0

// R1A12M106I

**Straight connector DIN 24° Male -
BSPP cylindric Male with elastomer
- Heavy series**

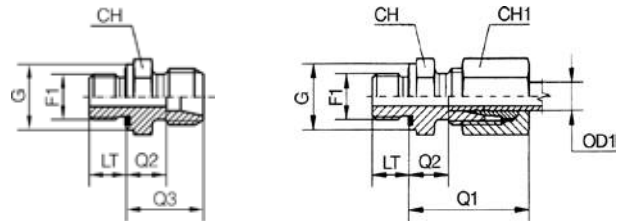

Item Code Body Only	Item Code Complete	Head 1 / Head 2	OD1 mm	F1	Q1 mm	Q2 mm	Q3 mm	CH mm	CH1 mm	LT mm	G mm
		mm									
1206133	1244066	-0604	6	1/4-19	28,0	13,0	20,0	19,0	17,0	12,0	19,0
1206049	1244067	-0804	8	1/4-19	30,0	15,0	22,0	19,0	19,0	12,0	19,0
1206134	1244068	-1006	10	3/8-19	31,0	15,0	22,5	22,0	22,0	12,0	22,0
1205901	1244069	-1206	12	3/8-19	33,0	17,0	24,5	22,0	24,0	12,0	22,0
1205762	1244070	-1408	14	1/2-14	37,0	19,0	27,0	27,0	27,0	14,0	27,0
1205763	1244071	-1608	16	1/2-14	37,0	18,5	27,0	27,0	30,0	14,0	27,0
1205764	1244072	-2012	20	3/4-14	42,0	20,5	31,0	32,0	36,0	16,0	32,0
1206047	1244073	-2516	25	1-11	47,0	23,0	35,0	41,0	46,0	18,0	40,0
1206416	1244074	-3020	30	1 1/4-11	50,0	23,5	37,0	50,0	50,0	20,0	50,0
1207842	1244075	-3820	38	1 1/4-11	57,0	26,0	42,0	55,0	60,0	20,0	50,0

Dimensions shown may be changed without prior notice

// R1A11M406N

**45° adjustable elbow connector DIN
24° Male - BSPP cylindric Male with
O-Ring and retaining ring - Light
series**

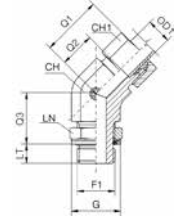
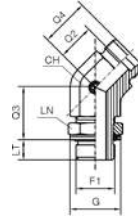

Item Code Body Only	Item Code Complete	Head 1 / Head 2	OD1	F1	Q1	Q2	Q3	Q4	CH	CH1	LN	LT	G
		mm / Dash											
1237030	1244929	-0602	6	1/8-28	24,5	9,5	21,7	16,5	14,0	14,0	14,0	6,3	16,0
1237031	1244930	-0804	8	1/4-19	27,0	12,0	19,5	19,0	14,0	17,0	19,0	9,5	20,5
1237032	1244931	-1004	10	1/4-19	27,0	12,0	24,5	19,0	19,0	19,0	19,0	9,5	20,5
1237033	1244932	-1206	12	3/8-19	29,0	14,0	27,5	21,0	19,0	22,0	22,0	9,5	24,0
1237034	1244933	-1508	15	1/2-14	32,0	17,0	26,0	24,0	22,0	27,0	27,0	13,0	29,0
1237035	1244934	-1808	18	1/2-14	33,0	17,0	32,0	24,5	27,0	32,0	27,0	13,0	29,0
1237036	1244935	-2212	22	3/4-14	35,5	19,5	37,5	27,0	33,0	36,0	36,0	13,0	35,0
1231360	1244936	-2816	28	1-11	39,0	23,0	36,0	30,5	41,0	41,0	41,0	16,0	44,5
1237038	1244937	-3520	35	1 1/4-11	48,0	27,0	38,0	37,5	48,0	50,0	50,0	16,0	53,0
1237039	1244938	-4224	42	1 1/2-11	49,0	26,0	38,0	37,0	48,0	60,0	55,0	16,0	58,5

// R1A12M406N

**45° adjustable elbow connector DIN
24° Male - BSPP cylindric Male with
O-Ring and retaining ring - Heavy
series**

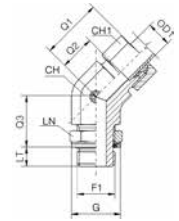
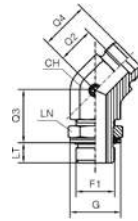

Item Code Body Only	Item Code Complete	Head 1 / Head 2	OD1	F1	Q1	Q2	Q3	Q4	CH	CH1	LN	LT	G
		mm / Dash											
1237054	1244999	-0604	6	1/4-19	26,0	11,0	18,5	18,5	14,0	17,0	19,0	9,5	20,5
1237055	1245000	-0804	8	1/4-19	28,0	13,0	22,5	20,5	19,0	19,0	19,0	9,5	20,5
1237056	1245001	-1006	10	3/8-19	29,0	13,0	24,5	20,5	19,0	22,0	22,0	9,5	24,0
1237057	1245002	-1206	12	3/8-19	33,0	17,0	24,5	24,5	22,0	24,0	22,0	9,5	24,0
1237058	1245003	-1608	16	1/2-14	34,0	16,0	31,0	24,5	27,0	30,0	27,0	13,0	29,0
1237059	1245004	-2012	20	3/4-14	40,0	19,0	33,0	29,5	33,0	36,0	36,0	13,0	35,0
1237060	1245005	-2516	25	1-11	46,0	22,0	35,0	34,0	41,0	46,0	41,0	16,0	44,5
1237061	1245006	-3020	30	1 1/4-11	50,0	24,0	37,0	37,5	48,0	50,0	50,0	16,0	53,0
1237062	1245007	-3824	38	1 1/2-11	55,0	24,0	37,0	40,0	48,0	60,0	55,0	16,0	58,5

// R1A11M906N

90° adjustable elbow connector DIN 24° Male - BSPP cylindric Male with O-Ring and retaining ring - Light series

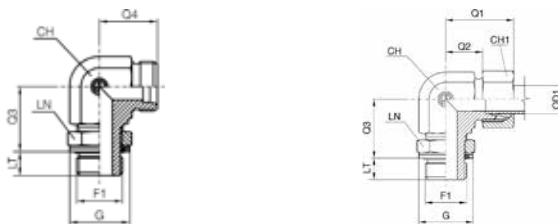

Item Code Body Only	Item Code Complete	Head 1 / Head 2	OD1	F1	Q1	Q2	Q3	Q4	CH	CH1	LN	LT	G
		mm/Dash											
1211135	1243847	-0602	6	1/8-28	29,0	14,0	20,2	21,0	14,0	14,0	14,0	6,3	16,0
1240312	1243848	-0804	8	1/4-19	31,0	16,0	22,5	23,0	14,0	17,0	19,0	9,5	20,5
1208111	1243849	-1004	10	1/4-19	32,0	17,0	24,5	24,0	19,0	19,0	19,0	9,5	20,5
1239726	1243850	-1206	12	3/8-19	34,0	19,0	27,5	26,0	19,0	22,0	22,0	9,5	24,0
1239727	1243851	-1508	15	1/2-14	36,0	21,0	30,0	28,0	22,0	27,0	27,0	13,0	29,0
1210735	1243852	-1808	18	1/2-14	40,0	24,0	36,5	31,5	27,0	32,0	27,0	13,0	29,0
1238730	1243853	-2212	22	3/4-14	44,0	28,0	37,5	35,5	33,0	36,0	36,0	13,0	35,0
1239728	1243854	-2816	28	1-11	47,0	31,0	41,0	38,5	41,0	41,0	41,0	16,0	44,5
1211136	1243855	-3520	35	1 1/4-11	59,0	38,0	49,0	48,5	48,0	50,0	50,0	16,0	53,0
1208116	1243856	-4224	42	1 1/2-11	61,0	38,0	51,0	49,0	48,0	60,0	55,0	16,0	58,5

// R1A12M906N

90° adjustable elbow connector DIN 24° Male - BSPP cylindric Male with O-Ring and retaining ring - Heavy series

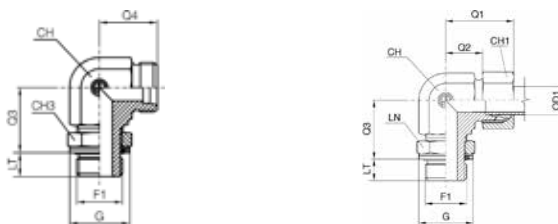

Item Code Body Only	Item Code Complete	Head 1 / Head 2	OD1	F1	Q1	Q2	Q3	Q4	CH	CH1	LN	LT	G
		mm/Dash											
1211298	1244205	-0604	6	1/4-19	30,5	15,5	22,5	22,5	14,0	17,0	19,0	9,5	20,5
1208092	1244206	-0804	8	1/4-19	33,0	18,0	26,5	25,0	19,0	19,0	19,0	9,5	20,5
1208093	1244207	-1006	10	3/8-19	34,0	18,0	28,5	25,5	19,0	22,0	22,0	9,5	24,0
1208094	1244208	-1206	12	3/8-19	38,0	22,0	28,5	29,5	22,0	24,0	22,0	9,5	24,0
1208095	1244209	-1608	16	1/2-14	43,0	25,0	36,0	33,5	27,0	30,0	27,0	13,0	29,0
1208096	1244210	-2012	20	3/4-14	49,0	28,0	38,0	38,5	33,0	36,0	36,0	13,0	35,0
1208097	1244211	-2516	25	1-11	54,5	30,5	41,0	42,5	41,0	46,0	41,0	16,0	44,5
1211299	1244212	-3020	30	1 1/4-11	62,0	36,0	48,0	49,5	48,0	50,0	50,0	16,0	53,0
1211300	1244213	-3824	38	1 1/2-11	65,0	34,0	53,0	50,0	48,0	60,0	55,0	16,0	58,5

Dimensions shown may be changed without prior notice

// R1A11MT06N

Branch Tee adjustable elbow connector DIN 24° Male - BSPP Male with O-Ring and retaining ring - Light series

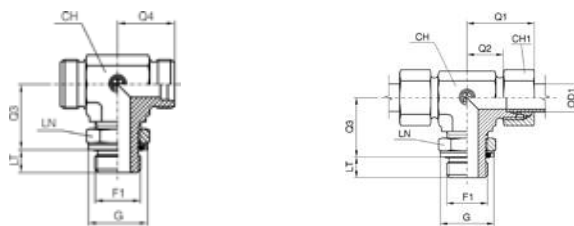

Item Code Body Only	Item Code Complete	Head 1 / Head 2	OD1	F1	Q1	Q2	Q3	Q4	CH	CH1	LN	LT	G
		mm / Dash			mm	mm	mm	mm	mm	mm	mm	mm	
1211050	1243964	-0602	6	M12X1.5	29,0	14,0	20,2	21,0	14,0	14,0	14,0	6,3	16,0
1211051	1243965	-0804	8	M14X1.5	31,0	16,0	22,5	23,0	14,0	17,0	19,0	9,5	20,5
1211052	1243966	-1004	10	M16X1.5	32,0	17,0	24,5	24,0	19,0	19,0	19,0	9,5	20,5
1211053	1243967	-1206	12	M18X1.5	34,0	19,0	27,5	26,0	19,0	22,0	22,0	9,5	24,0
1237042	1243968	-1508	15	M22X1.5	36,0	21,0	30,0	28,0	22,0	27,0	27,0	13,0	29,0
1211055	1243969	-1808	18	M26X1.5	40,0	24,0	36,5	31,5	27,0	32,0	27,0	13,0	29,0
1211056	1243970	-2212	22	M30X2	44,0	28,0	37,5	35,5	33,0	36,0	36,0	13,0	35,0
1231369	1243971	-2816	28	M36X2	47,0	31,0	41,0	38,5	41,0	41,0	41,0	16,0	44,5
1208182	1243972	-3520	35	M45X2	59,0	38,0	49,0	48,5	48,0	50,0	50,0	16,0	53,0
1211058	1243973	-4224	42	M52X2	61,0	38,0	51,0	49,0	48,0	60,0	55,0	16,0	58,5

// R1A12MT06N

Branch Tee adjustable elbow connector DIN 24° Male - BSPP Male with O-Ring and retaining ring - Heavy series

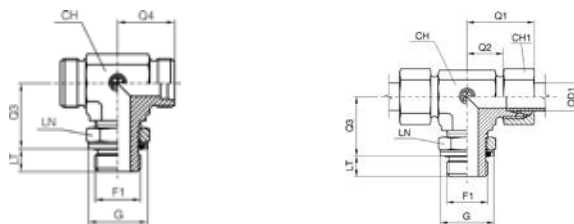

Item Code Body Only	Item Code Complete	Head 1 / Head 2	OD1	F1	Q1	Q2	Q3	Q4	CH	CH1	LN	LT	G
		mm / Dash			mm	mm	mm	mm	mm	mm	mm	mm	
1211236	1244331	-0604	6	M14X1.5	30,5	15,5	22,5	22,5	14,0	17,0	19,0	9,5	20,5
1231381	1244332	-0804	8	M16X1.5	33,0	18,0	26,5	25,0	19,0	19,0	19,0	9,5	20,5
1211238	1244333	-1006	10	M18X1.5	34,0	18,0	28,5	25,5	19,0	22,0	22,0	9,5	24,0
1211239	1244334	-1206	12	M20X1.5	38,0	22,0	28,5	29,5	22,0	24,0	22,0	9,5	24,0
1211240	1244335	-1608	16	M24X1.5	43,0	25,0	36,0	33,5	27,0	30,0	27,0	13,0	29,0
1211241	1244336	-2012	20	M30X2	49,0	28,0	38,0	38,5	33,0	36,0	36,0	13,0	35,0
1211242	1244337	-2516	25	M36X2	54,5	30,5	41,0	42,5	41,0	46,0	41,0	16,0	44,5
1211243	1244338	-3020	30	M42X2	62,0	36,0	48,0	49,5	48,0	50,0	50,0	16,0	53,0
1211244	1244339	-3824	38	M52X2	65,0	34,0	53,0	50,0	48,0	60,0	55,0	16,0	58,5

// R1A11ML06N

**Run Tee adjustable elbow connector
DIN 24° Male - BSPP Male with
O-Ring and retaining ring - Light
series**

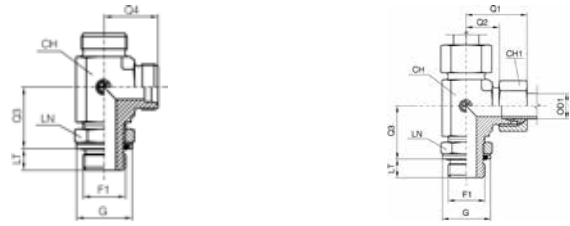

Item Code Body Only	Item Code Complete	Head 1 / Head 2	OD1	F1	Q1	Q2	Q3	Q4	CH	CH1	LN	LT	G
		mm / Dash											
1211019	1243929	-0602	6	1/8-28	29,0	14,0	20,2	21,0	14,0	14,0	14,0	6,3	16,0
1210734	1243930	-0804	8	1/4-19	31,0	16,0	22,5	23,0	14,0	17,0	19,0	9,5	20,5
1211020	1243931	-1004	10	1/4-19	32,0	17,0	24,5	24,0	19,0	19,0	19,0	9,5	20,5
1211021	1243932	-1206	12	3/8-19	34,0	19,0	27,5	26,0	19,0	22,0	22,0	9,5	24,0
1211022	1243933	-1508	15	1/2-14	36,0	21,0	30,0	28,0	22,0	27,0	27,0	13,0	29,0
1211023	1243934	-1808	18	1/2-14	40,0	24,0	36,5	31,5	27,0	32,0	27,0	13,0	29,0
1231368	1243935	-2212	22	3/4-14	44,0	28,0	37,5	35,5	33,0	36,0	36,0	13,0	35,0
1211025	1243936	-2816	28	1-11	47,0	31,0	41,0	38,5	41,0	41,0	41,0	16,0	44,5
1211026	1243937	-3520	35	1 1/4-11	59,0	38,0	49,0	48,5	48,0	50,0	50,0	16,0	53,0
1211027	1243938	-4224	42	1 1/2-11	61,0	38,0	51,0	49,0	48,0	60,0	55,0	16,0	58,5

// R1A12ML06N

**Run Tee adjustable elbow connector
DIN 24° Male - BSPP Male with
O-Ring and retaining ring - Heavy
series**



Item Code Body Only	Item Code Complete	Head 1 / Head 2	OD1	F1	Q1	Q2	Q3	Q4	CH	CH1	LN	LT	G
		mm / Dash											
1211207	1244293	-0604	6	1/4-19	30,5	15,5	22,5	22,5	14,0	17,0	19,0	9,5	20,5
1231380	1244294	-0804	8	1-11	33,0	18,0	26,5	25,0	19,0	19,0	19,0	9,5	20,5
1211209	1244295	-1006	10	3/8-19	34,0	18,0	28,5	25,5	19,0	22,0	22,0	9,5	24,0
1211210	1244296	-1206	12	3/8-19	38,0	22,0	28,5	29,5	22,0	24,0	22,0	9,5	24,0
1211211	1244297	-1608	16	1/2-14	43,0	25,0	36,0	33,5	27,0	30,0	27,0	13,0	29,0
1211212	1244298	-2012	20	3/4-14	49,0	28,0	38,0	38,5	33,0	36,0	36,0	13,0	35,0
1211213	1244299	-2516	25	1-11	54,5	30,5	41,0	42,5	41,0	46,0	41,0	16,0	44,5
1211214	1244300	-3020	30	1 1/4-11	62,0	36,0	48,0	49,5	48,0	50,0	50,0	16,0	53,0
1211215	1244301	-3824	38	1 1/2-11	65,0	34,0	53,0	50,0	48,0	60,0	55,0	16,0	58,5

Dimensions shown may be changed without prior notice

// R1A152106I

**Straight connector DIN 24° Female with O-Ring - BSPP cylindric
Male with elastomer - Light series**

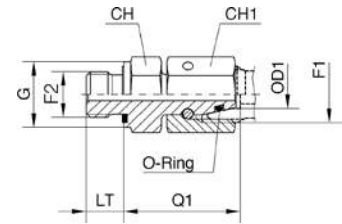

Item Code	Head 1 / Head 2	OD1	F1	F2	Q1	LT	CH	CH1	G
	mm								
1211383	-0602	6	M12X1.5	1/8-28	24,5	8,0	14,0	14,0	14,0
1206931	-0804	8	M14X1.5	1/4-19	29,5	12,0	19,0	17,0	19,0
1206814	-1004	10	M16X1.5	1/4-19	27,5	12,0	19,0	19,0	19,0
1206558	-1206	12	M18X1.5	3/8-19	34,0	12,0	22,0	22,0	22,0
1208084	-1508	15	M22X1.5	1/2-14	32,0	14,0	27,0	27,0	27,0
1208044	-1808	18	M26X1.5	1/2-14	31,5	14,0	27,0	32,0	27,0
1208085	-2212	22	M30X2	3/4-14	32,5	16,0	32,0	36,0	32,0
1211384	-2816	28	M36X2	1-11	35,0	18,0	41,0	41,0	40,0
1211385	-3520	35	M45X2	1 1/4-11	42,5	20,0	50,0	50,0	50,0
1211386	-4224	42	M52X2	1 1/2-11	46,5	22,0	55,0	60,0	55,0

// R1A162106I

**Straight connector DIN 24° Female with O-Ring - BSPP cylindric
Male with elastomer - Heavy series**

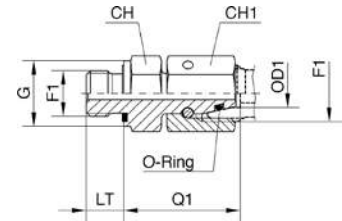

Item Code	Head 1 / Head 2	OD1	F1	F2	Q1	LT	CH	CH1	G
	mm								
1211448	-0604	6	M14X1.5	1/4-19	27,0	12,0	19,0	17,0	19,0
1206834	-0804	8	M16X1.5	1/4-19	29,5	12,0	19,0	19,0	19,0
1208168	-1006	10	M18X1.5	3/8-19	32,0	12,0	22,0	22,0	22,0
1208169	-1206	12	M20X1.5	3/8-19	34,0	12,0	22,0	24,0	22,0
1208170	-1408	14	M22X1.5	1/2-14	36,5	14,0	27,0	27,0	27,0
1206561	-1608	16	M24X1.5	1/2-14	37,0	14,0	27,0	30,0	27,0
1207555	-2012	20	M30X2	3/4-14	43,0	16,0	32,0	36,0	32,0
1207131	-2516	25	M36X2	1-11	48,0	18,0	41,0	46,0	40,0
1207544	-3020	30	M42X2	1 1/4-11	51,0	20,0	50,0	50,0	50,0
1211449	-3824	38	M52X2	1 1/2-11	60,0	22,0	55,0	60,0	55,0

// R1A113106I

Straight connector DIN 24° Female pre-assembled - BSPP cylindric Male with elastomer - Light series

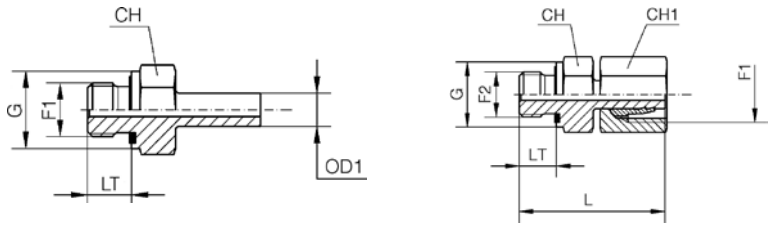

Item Code Body Only	Item Code Complete	Head 1 / Head 2	OD1	F1	F2	LT	CH	CH1	G	L
		mm	mm							
1206303	1243688	-0602	6	M12X1.5	1/8-28	8,0	14,0	14,0	14,0	32,5
1205583	1243689	-0804	8	M14X1.5	1/4-19	12,0	19,0	17,0	19,0	41,5
1205573	1243690	-1004	10	M16X1.5	1/4-19	12,0	19,0	19,0	19,0	39,5
1205553	1243691	-1206	12	M18X1.5	3/8-19	12,0	22,0	22,0	22,0	46,0
1205554	1243692	-1508	15	M22X1.5	1/2-14	14,0	27,0	27,0	27,0	46,0
1205766	1243693	-1808	18	M26X1.5	1/2-14	14,0	27,0	32,0	27,0	45,5
1205555	1243694	-2212	22	M30X2	3/4-14	16,0	32,0	36,0	32,0	48,5
1206073	1243695	-2816	28	M36X2	1-11	18,0	41,0	41,0	40,0	53,0
1206000	1243696	-3520	35	M45X2	1 1/4-11	20,0	50,0	50,0	50,0	62,5
1206492	1243697	-4224	42	M52X2	1 1/2-11	22,0	55,0	60,0	55,0	68,5

// R1A123106I

Straight connector DIN 24° Female pre-assembled - BSPP cylindric Male with elastomer - Heavy series

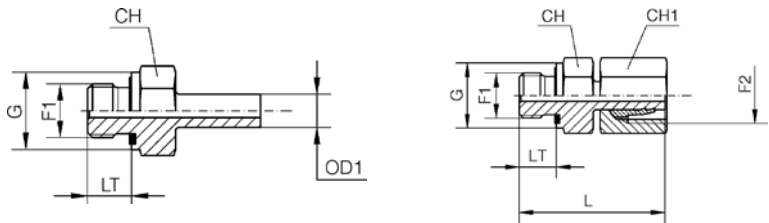

Item Code Body Only	Item Code Complete	Head 1 / Head 2	OD1	F1	F2	LT	CH	CH1	G	L
		mm	mm							
1206485	1244027	-0604	6	M14X1.5	1/4-19	12,0	19,0	17,0	19,0	39,0
1206035	1244028	-0804	8	M16X1.5	1/4-19	12,0	19,0	19,0	19,0	41,5
1206487	1244029	-1006	10	M18X1.5	3/8-19	12,0	22,0	22,0	22,0	44,5
1206034	1244030	-1206	12	M20X1.5	3/8-19	12,0	22,0	24,0	22,0	46,0
1206033	1244031	-1408	14	M22X1.5	1/2-14	14,0	27,0	27,0	27,0	51,0
1206032	1244032	-1608	16	M24X1.5	1/2-14	14,0	27,0	30,0	27,0	50,5
1206031	1244033	-2012	20	M30X2	3/4-14	16,0	32,0	36,0	32,0	59,0
1206030	1244034	-2516	25	M36X2	1-11	18,0	41,0	46,0	40,0	66,0
1206490	1244035	-3020	30	M42X2	1 1/4-11	20,0	50,0	50,0	50,0	71,0
1206491	1244036	-3824	38	M52X2	1 1/2-11	22,0	55,0	60,0	55,0	82,0

Dimensions shown may be changed without prior notice

// R1A11ME06M

**Banjo elbow - Type B - BSPP Male
DIN 24° - Light series**

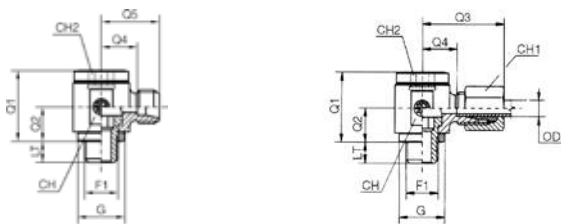

Item Code Body Only	Item Code Complete	Head 1 / Head 2	OD1	F1	Q1	Q2	Q3	Q4	Q5	LT	CH	CH1	CH2	G
		mm			mm	mm	mm	mm	mm					
1207054	1243904	-0602	6	1/8-28	24,0	12,0	27,0	12,5	19,5	8,0	19,0	14,0	6,0	14,0
1206158	1243905	-0804	8	1/4-19	30,0	16,0	29,0	14,5	21,5	12,0	22,0	17,0	8,0	18,0
1243686	1243906	-1004	8	1/4-19	30,0	16,0	30,0	15,5	23,0	12,0	22,0	19,0	8,0	18,0
1206160	1243907	-1206	12	3/8-19	37,0	18,0	33,0	18,0	25,5	12,0	27,0	22,0	10,0	22,0
1206277	1243908	-1508	15	1/2-14	42,0	21,0	37,0	22,0	29,0	14,0	32,0	27,0	12,0	26,0
1211007	1243909	-1808	18	1/2-14	46,0	23,0	38,0	21,5	29,0	14,0	36,0	32,0	12,0	26,0
1211008	1243910	-2212	22	3/4-14	58,0	28,0	45,0	28,5	36,0	16,0	46,0	36,0	17,0	32,0
1208107	1243911	-2816	28	1-11	64,0	32,0	48,0	31,5	39,0	18,0	50,0	41,0	22,0	39,0
1206161	1243912	-3520	35	1 1/4-11	76,0	37,0	57,0	35,5	46,0	20,0	60,0	50,0	27,0	49,0
1211009	1243913	-4224	42	1 1/2-11	85,0	42,0	63,0	40,0	52,5	22,0	70,0	60,0	32,0	55,0

// R1A12ME06M

**Banjo elbow - Type B - BSPP Male
DIN 24° - Heavy series**

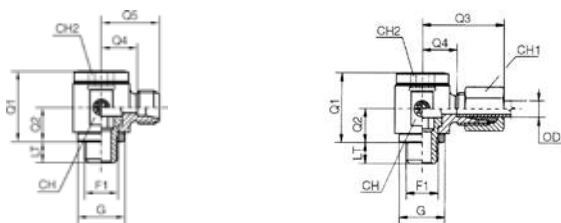

Item Code Body Only	Item Code Complete	Head 1 / Head 2	OD1	F1	Q1	Q2	Q3	Q4	Q5	LT	CH	CH1	CH2	G
		mm			mm	mm	mm	mm	mm					
1206114	1244268	-0604	6	1/4-19	30,0	16,0	31,0	16,5	23,5	12,0	22,0	17,0	8,0	18,0
1206115	1244269	-0804	8	1/4-19	30,0	16,0	31,0	16,5	23,5	12,0	22,0	19,0	8,0	18,0
1206116	1244270	-1006	10	3/8-19	37,0	18,0	35,0	18,5	26,0	12,0	27,0	22,0	10,0	22,0
1206117	1244271	-1206	12	3/8-19	37,0	18,0	35,0	18,5	26,0	12,0	27,0	24,0	10,0	22,0
1207059	1244267	-1408	14	1/2-14	42,0	21,0	41,0	23,0	31,0	14,0	32,0	27,0	12,0	26,0
1211197	1244272	-2012	20	3/4-14	58,0	28,0	49,0	27,5	38,0	16,0	46,0	36,0	17,0	32,0
1211198	1244273	-2516	25	1-11	64,0	32,0	55,0	31,0	43,0	18,0	50,0	46,0	22,0	39,0
1211199	1244274	-3020	30	1 1/4-11	76,0	37,0	63,0	36,5	50,0	20,0	60,0	50,0	27,0	49,0
1208220	1244275	-3824	38	1 1/2-11	85,0	42,0	72,0	41,0	58,5	22,0	70,0	60,0	32,0	55,0

// R1A11ME035

**Banjo elbow - Type A - BSPP Male
DIN 24° - Light series**

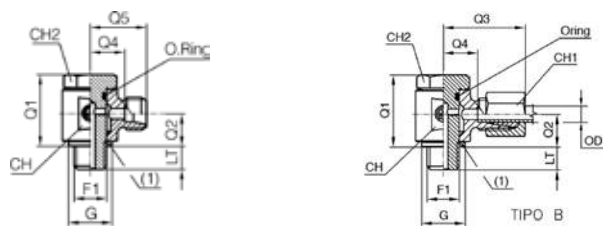

Item Code Body Only	Item Code Complete	Head 1 / Head 2	OD1	F1	Q1	Q2	Q3	Q4	Q5	LT	CH	CH1	CH2	G
		mm												
1206576	1243897	-0602	6	1/8-28	27,0	12,5	29,0	13,0	20,0	8,0	19,0	14,0	17,0	15,0
1206148	1243898	-0804	8	1/4-19	30,5	15,0	30,5	14,5	21,5	12,0	22,0	17,0	19,0	18,0
1206149	1243899	-1004	10	1/4-19	30,5	15,0	32,0	15,5	22,5	12,0	22,0	19,0	19,0	18,0
1206150	1243900	-1206	12	3/8-19	38,5	19,0	36,0	19,5	26,5	12,0	30,0	22,0	24,0	22,0
1206530	1243901	-1508	15	1/2-14	48,0	23,0	39,0	22,5	29,5	14,0	36,0	27,0	27,0	26,0
1206531	1243902	-1808	18	1/2-14	48,0	23,0	40,0	22,0	29,5	14,0	36,0	32,0	27,0	26,0
1207006	1243903	-2212	22	1/8-28	56,0	26,0	47,0	28,0	35,5	16,0	41,0	36,0	32,0	32,0

// R1A12ME035

**Banjo elbow - Type A - BSPP Male
DIN 24° - Heavy series**

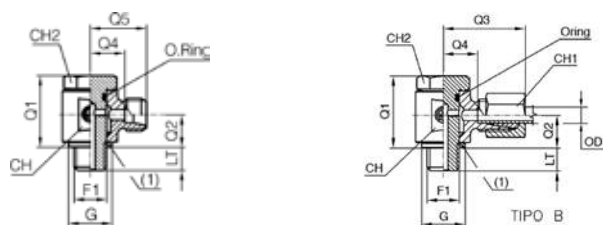

Item Code Body Only	Item Code Complete	Head 1 / Head 2	OD1	F1	Q1	Q2	Q3	Q4	Q5	LT	CH	CH1	CH2	G
		mm												
1206098	1244261	-0604	6	1/4-19	30,5	15,0	33,0	16,5	23,5	12,0	22,0	17,0	19,0	18,0
1207025	1244262	-0804	8	1/4-19	30,5	15,0	32,5	16,5	23,5	12,0	22,0	19,0	19,0	18,0
1206532	1241550	-1006	10	3/8-19	38,5	19,0	38,0	20,0	27,5	12,0	30,0	22,0	24,0	22,0
1206151	1244263	-1206	12	3/8-19	38,5	19,0	38,0	20,0	27,5	12,0	30,0	24,0	24,0	22,0
1206582	1244264	-1408	14	1/2-14	48,0	23,0	42,5	23,5	31,5	14,0	36,0	27,0	27,0	26,0
1206533	1244265	-1608	16	1/2-14	48,0	23,0	43,0	23,0	31,5	14,0	36,0	30,0	27,0	26,0
1206583	1244266	-2012	20	3/4-14	56,0	26,0	51,5	27,0	37,5	16,0	41,0	36,0	32,0	32,0

Dimensions shown may be changed without prior notice

// R1A06F106I

Straight connector BSPP Female - BSPP Male with elastomer

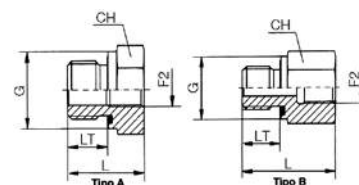

Item Code	Head 1 / Head 2	F2	CH	L	LT	G	Type
	Dash		mm	mm	mm	mm	
1206431	-0204	1/4-19	19,0	31,0	8,0	14,0	B
1206511	-0206	3/8-19	24,0	32,0	8,0	14,0	B
1206510	-0402	1/8-28	19,0	29,0	12,0	19,0	B
1206432	-0406	3/8-19	24,0	36,0	12,0	19,0	B
1206016	-0408	1/2-14	30,0	40,0	12,0	19,0	B
1206512	-0412	3/4-14	36,0	43,0	12,0	19,0	B
1206509	-0602	1/8-28	22,0	22,5	12,0	22,0	A
1206508	-0604	1/4-19	22,0	36,0	12,0	22,0	B
1206513	-0608	1/2-14	30,0	41,0	12,0	22,0	B
1206514	-0612	3/4-14	36,0	44,0	12,0	22,0	B
1207863	-0802	1/8-28	27,0	24,0	14,0	27,0	A
1206507	-0804	1/4-19	27,0	24,0	14,0	27,0	A
1206506	-0806	3/8-19	27,0	37,0	14,0	27,0	B
1206515	-0812	3/4-14	36,0	46,0	14,0	27,0	B
1206420	-0816	1-11	41,0	49,0	14,0	27,0	B
1206516	-0820	1 1/4-11	55,0	53,0	14,0	27,0	B
1206505	-1204	1/4-19	32,0	26,0	16,0	32,0	A
1206504	-1206	3/8-19	32,0	26,0	16,0	32,0	A
1206419	-1208	1/2-14	32,0	43,0	16,0	32,0	B
1206418	-1216	1-11	41,0	51,0	16,0	32,0	B
1206422	-1220	1 1/4-11	55,0	55,0	16,0	32,0	B
1206421	-1224	1 1/2-11	60,0	57,0	16,0	32,0	B
1206503	-1604	1/4-19	41,0	29,0	18,0	40,0	A
1206502	-1606	3/8-19	41,0	29,0	18,0	40,0	A
1206501	-1608	1/2-14	41,0	29,0	18,0	40,0	A
1206500	-1612	3/4-14	41,0	49,0	18,0	40,0	B
1206517	-1620	1 1/4-11	55,0	57,0	18,0	40,0	B
1206518	-1624	1 1/2-11	60,0	59,0	18,0	40,0	B
1206499	-2008	1/2-14	50,0	32,0	20,0	50,0	A
1206497	-2012	3/4-14	50,0	32,0	20,0	50,0	A
1206465	-2016	1-11	50,0	53,0	20,0	50,0	B
1206519	-2024	1 1/2-11	60,0	60,0	20,0	50,0	B
1206496	-2408	1/2-14	55,0	36,0	22,0	55,0	A
1206495	-2412	3/4-14	55,0	36,0	22,0	55,0	A
1206494	-2416	1-11	55,0	36,0	22,0	55,0	A
1206493	-2420	1 1/4-11	55,0	58,0	22,0	55,0	B

// BSPT

// R1A11M107M

**Straight connector DIN 24° Male
- BSPT cylindric flat Male - Light
series**

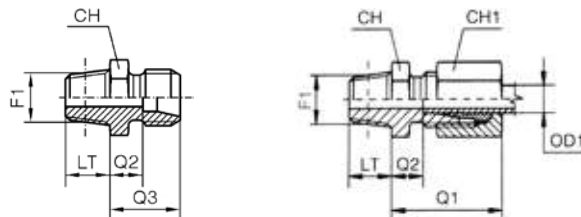

Item Code Body Only	Item Code Complete	Head 1 / Head 2	OD1	F1	Q1	Q2	Q3	CH	CH1	LT
		mm								
1205767	1241561	-0602	6	1/8-28	23,0	7,0	14,0	12,0	14,0	10,0
1206219	1242147	-0604	6	1/4-19	24,0	8,0	15,0	17,0	14,0	13,0
1206606	1241564	-0802	8	1/8-28	25,0	8,0	15,0	14,0	17,0	10,0
1205584	1244913	-0804	8	1/4-19	25,0	8,0	15,0	17,0	17,0	13,0
1205587	1241960	-0806	8	3/8-19	26,0	9,0	16,0	19,0	17,0	13,0
1206221	1244914	-0808	8	1/2-14	26,0	9,0	16,0	22,0	17,0	16,0
1206454	1244915	-1002	10	1/8-28	26,0	9,0	16,0	17,0	19,0	10,0
1204289	1241526	-1004	10	1/4-19	26,0	9,0	16,0	17,0	19,0	13,0
1204290	1244916	-1006	10	3/8-19	27,0	10,0	17,0	19,0	19,0	13,0
1204288	1244917	-1008	10	1/2-14	27,0	10,0	17,0	22,0	19,0	16,0
1205482	1241566	-1204	12	1/4-19	27,0	10,0	17,0	19,0	22,0	13,0
1204293	1244918	-1206	12	3/8-19	27,0	10,0	17,0	19,0	22,0	13,0
1204292	1244919	-1208	12	1/2-14	27,0	10,0	17,0	22,0	22,0	16,0
1205768	1244920	-1506	15	3/8-19	29,0	11,0	18,0	24,0	27,0	13,0
1204296	1244921	-1508	15	1/2-14	29,0	11,0	18,0	24,0	27,0	16,0
1244867	1244922	-1806	18	3/8-19	31,0	11,5	19,0	27,0	32,0	13,0
1205769	1244923	-1808	18	1/2-14	31,0	11,5	19,0	27,0	32,0	16,0
1208156	1244924	-1812	18	3/4-14	32,0	11,5	19,0	32,0	32,0	18,0
1205770	1244925	-2212	22	3/4-14	33,0	13,5	21,0	32,0	36,0	18,0
1205771	1244926	-2816	28	1-11	34,0	14,5	22,0	41,0	41,0	20,0
1244868	1244927	-3516	35	1-11	39,0	14,5	25,0	46,0	50,0	20,0
1206046	1244928	-3520	35	1 1/4-11	39,0	14,5	25,0	46,0	50,0	21,0

Dimensions shown may be changed without prior notice

// R1A12M107M

**Straight connector DIN 24° Male
- BSPT cylindric flat Male - Heavy
series**

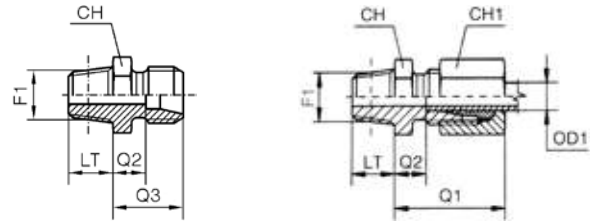

Item Code Body Only	Item Code Complete	Head 1 / Head 2	OD1 mm	F1	Q1 mm	Q2 mm	Q3 mm	CH mm	CH1 mm	LT mm
		mm								
1205772	1244989	-0604	6	1/4-19	28,0	12,0	19,0	17,0	17,0	13,0
1205773	1244990	-0804	8	1/4-19	30,0	13,0	20,0	17,0	19,0	13,0
1245379	1245384	-1004	10	1/4-19	31,0	12,5	20,0	19,0	22,0	13,0
1244891	1244991	-1006	10	3/8-19	31,0	12,5	20,0	19,0	22,0	13,0
1245380	1245385	-1204	12	1/4-19	33,0	14,5	22,0	22,0	24,0	13,0
1244892	1244992	-1206	12	3/8-19	33,0	14,5	22,0	22,0	24,0	13,0
1245381	1245386	-1208	12	1/2-14	33,0	14,5	22,0	22,0	24,0	16,0
1205776	1245388	-1406	14	3/8-19	37,0	16,0	24,0	24,0	27,0	13,0
1205894	1244993	-1408	14	1/2-14	37,0	16,0	24,0	24,0	27,0	16,0
1206082	1245389	-1606	16	3/8-19	37,0	17,5	26,0	27,0	30,0	13,0
1205777	1244994	-1608	16	1/2-14	37,0	17,5	26,0	27,0	30,0	16,0
1205778	1244995	-2012	20	3/4-14	42,0	17,5	28,0	32,0	36,0	18,0
1244893	1244996	-2516	25	1-11	47,0	18,0	30,0	41,0	46,0	20,0
1245382	1245390	-3016	30	1-11	50,0	19,5	33,0	46,0	50,0	20,0
1206916	1244997	-3020	30	1 1/4-11	50,0	19,5	33,0	46,0	50,0	21,0
1245383	1245391	-3820	38	1 1/4-11	57,0	22,0	38,0	55,0	60,0	21,0
1207841	1244998	-3824	38	1 1/2-11	57,0	22,0	38,0	55,0	60,0	22,0

// R1A11M907M

**90° connector DIN 24° Male - BSPT
Male - Light series**

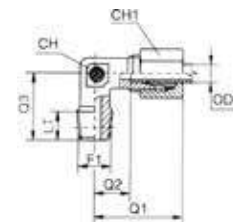
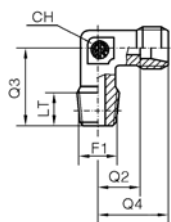

Item Code Body Only	Item Code Complete	Head 1 / Head 2	OD1 mm	F1	Q1 mm	Q2 mm	Q3 mm	Q4 mm	CH mm	CH1 mm	LT mm
		mm/Dash									
1205780	1244959	-0602	6	1/8-28	27,0	12,0	20,0	19,0	12,0	14,0	8,0
1204096	1241962	-0604	6	1/4-19	29,0	14,0	26,0	21,0	12,0	14,0	12,0
1206232	1244960	-0802	8	1/8-28	29,0	14,0	26,0	21,0	12,0	17,0	8,0
1205781	1243352	-0804	8	1/4-19	29,0	14,0	26,0	21,0	12,0	17,0	12,0
1204098	1241091	-0806	8	3/8-19	32,0	17,0	28,0	24,0	17,0	17,0	12,0
1205782	1242418	-1004	10	1/4-19	30,0	15,0	27,0	22,0	14,0	19,0	12,0
1204085	1244961	-1006	10	3/8-19	32,0	17,0	28,0	24,0	17,0	19,0	12,0
1206181	1244962	-1008	10	1/2-14	36,0	21,0	34,0	28,0	19,0	19,0	14,0
1205521	1241567	-1204	12	1/4-19	32,0	17,0	28,0	24,0	17,0	22,0	12,0
1204089	1241475	-1206	12	3/8-19	32,0	17,0	28,0	24,0	17,0	22,0	12,0
1204088	1244963	-1208	12	1/2-14	36,0	21,0	34,0	28,0	19,0	22,0	14,0
1205783	1244964	-1506	15	3/8-19	36,0	21,0	34,0	28,0	19,0	27,0	12,0
1204092	1244965	-1508	15	1/2-14	36,0	21,0	34,0	28,0	19,0	27,0	14,0
1205784	1241843	-1808	18	1/2-14	40,0	23,5	36,0	31,0	24,0	32,0	14,0
1205785	1244966	-2212	22	3/4-14	44,0	27,5	42,0	25,0	27,0	36,0	16,0
1206569	1244967	-2816	28	1-11	47,0	30,5	48,0	38,0	36,0	41,0	18,0
1244886	1244968	-3520	35	1 1/4-11	56,0	34,5	54,0	45,0	41,0	50,0	20,0
1244887	1244969	-4224	42	1 1/2-11	63,0	40,0	61,0	51,0	50,0	60,0	22,0

// R1A12M907M

**90° connector DIN 24° Male - BSPT
Male - Heavy series**

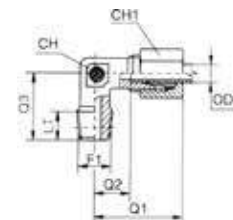
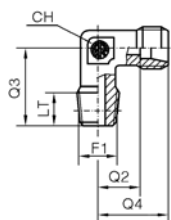

Item Code Body Only	Item Code Complete	Head 1 / Head 2	OD1 mm	F1	Q1 mm	Q2 mm	Q3 mm	Q4 mm	CH mm	CH1 mm	LT mm
		mm/Dash									
1205786	1245026	-0604	6	1/4-19	31,0	16,0	26,0	23,0	12,0	17,0	12,0
1205787	1245027	-0804	8	1/4-19	32,0	17,0	27,0	24,0	14,0	19,0	12,0
1205788	1245028	-1006	10	3/8-19	34,0	17,5	28,0	25,0	17,0	22,0	12,0
1205789	1245029	-1206	12	3/8-19	38,0	21,5	31,0	29,0	17,0	24,0	12,0
1206792	1245030	-1208	12	1/2-14	39,0	22,5	32,0	30,0	19,0	24,0	14,0
1205791	1245031	-1408	14	1/2-14	40,0	22,0	32,0	30,0	19,0	27,0	14,0
1206722	1245032	-1606	16	3/8-19	43,0	24,5	32,0	33,0	24,0	30,0	12,0
1205792	1245033	-1608	16	1/2-14	43,0	24,5	32,0	33,0	24,0	30,0	14,0
1205793	1245034	-2012	20	3/4-14	48,0	26,5	42,0	37,0	27,0	36,0	16,0
1207845	1245035	-2516	25	1-11	54,0	30,0	48,0	42,0	36,0	46,0	18,0
1207846	1245036	-3020	30	1 1/4-11	62,0	35,5	54,0	49,0	41,0	50,0	20,0
1241128	1245037	-3824	38	1 1/2-11	72,0	41,0	61,0	57,0	50,0	60,0	22,0

Dimensions shown may be changed without prior notice

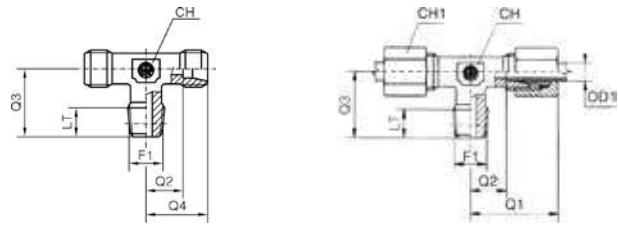
// R1A11MT07M**Branch Tee connector DIN 24° Male -
BSPT Male - Light series**

Item Code Body Only	Item Code Complete	Head 1 / Head 2	OD1 mm	F1	Q1 mm	Q2 mm	Q3 mm	Q4 mm	CH mm	CH1 mm	LT mm
		mm/Dash									
1206237	1244980	-0602	6	M12X1.5	27,0	12,0	20,0	19,0	12,0	14,0	8,0
1205794	1242713	-0804	8	M14X1.5	29,0	14,0	26,0	21,0	12,0	17,0	12,0
1205795	1244981	-1004	10	M16X1.5	30,0	15,0	27,0	22,0	14,0	19,0	12,0
1205796	1244982	-1206	12	M18X1.5	32,0	17,0	28,0	24,0	17,0	22,0	12,0
1206123	1244983	-1508	15	M22X1.5	36,0	21,0	34,0	28,0	19,0	27,0	14,0
1206124	1244985	-2212	22	M30X2	44,0	27,5	42,0	35,0	27,0	36,0	16,0
1207819	1244986	-2816	28	M36X2	47,0	30,5	48,0	38,0	36,0	41,0	18,0
1207820	1244987	-3520	35	M45X2	56,0	34,5	54,0	45,0	41,0	50,0	20,0
1207821	1244988	-4224	42	M52X2	63,0	40,0	61,0	51,0	50,0	60,0	22,0

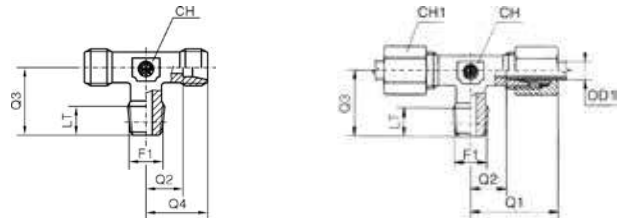
// R1A12MT07M**Branch Tee connector DIN 24° Male -
BSPT Male - Heavy series**

Item Code Body Only	Item Code Complete	Head 1 / Head 2	OD1 mm	F1	Q1 mm	Q2 mm	Q3 mm	Q4 mm	CH mm	CH1 mm	LT mm
		mm/Dash									
1207028	1245048	-0604	6	M14X1.5	31,0	16,0	26,0	23,0	12,0	17,0	12,0
1207029	1245049	-0804	8	M16X1.5	32,0	17,0	27,0	24,0	14,0	19,0	12,0
1207030	1245050	-1006	10	M18X1.5	34,0	17,5	28,0	25,0	17,0	22,0	12,0
1207031	1245051	-1206	12	M20X1.5	38,0	21,5	31,0	29,0	17,0	24,0	12,0
1207851	1245052	-1408	14	M22X1.5	40,0	22,0	32,0	30,0	19,0	27,0	14,0
1206239	1245053	-1608	16	M24X1.5	43,0	24,5	32,0	33,0	24,0	30,0	14,0
1245394	1245397	-2012	20	M30X2	48,0	26,5	42,0	37,0	27,0	36,0	16,0
1207852	1245054	-2516	25	M36X2	54,0	30,0	48,0	42,0	36,0	46,0	18,0
1245395	1245398	-3020	30	M42X2	62,0	35,5	54,0	49,0	41,0	50,0	20,0

// R1A11ML07M

**Run Tee connector DIN 24° Male -
BSPT Male - Light series**

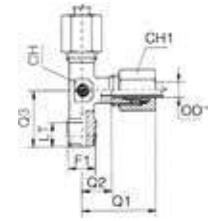
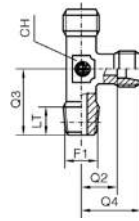

Item Code Body Only	Item Code Complete	Head 1 / Head 2	OD1 mm	F1	Q1 mm	Q2 mm	Q3 mm	Q4 mm	CH mm	CH1 mm	LT mm
		mm/Dash									
1211017	1244971	-0804	8	1/4-19	29,0	14,0	26,0	21,0	12,0	17,0	12,0
1206723	1244972	-1004	10	1/4-19	30,0	15,0	27,0	22,0	14,0	19,0	12,0
1206236	1244973	-1206	12	3/8-19	32,0	17,0	28,0	24,0	17,0	22,0	12,0
1206409	1244974	-1508	15	1/2-14	36,0	21,0	34,0	38,0	19,0	27,0	14,0
1244888	1244976	-2212	22	3/4-14	44,0	27,5	42,0	35,0	27,0	36,0	16,0
1244889	1244977	-2816	28	1-11	47,0	30,5	48,0	38,0	36,0	41,0	18,0
1207818	1244978	-3520	35	1 1/4-11	56,0	34,5	54,0	45,0	41,0	50,0	20,0
1244890	1244979	-4224	42	1 1/2-11	63,0	40,0	61,0	51,0	50,0	60,0	22,0

// R1A12ML07M

**Run Tee connector DIN 24° Male -
BSPT Male - Heavy series**

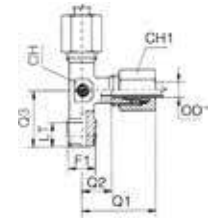
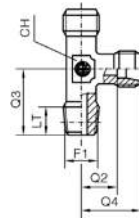

Item Code Body Only	Item Code Complete	Head 1 / Head 2	OD1 mm	F1	Q1 mm	Q2 mm	Q3 mm	Q4 mm	CH mm	CH1 mm	LT mm
		mm/Dash									
1211204	1245038	-0604	6	1/4-19	31,0	16,0	26,0	23,0	12,0	17,0	12,0
1211205	1245039	-0804	8	1/4-19	32,0	17,0	27,0	24,0	14,0	19,0	12,0
1207847	1245040	-1006	10	3/8-19	34,0	17,5	28,0	25,0	17,0	22,0	12,0
1207848	1245041	-1206	12	3/8-19	38,0	21,5	31,0	29,0	17,0	24,0	12,0
1211206	1245042	-1408	14	1/2-14	40,0	22,0	32,0	30,0	19,0	27,0	14,0
1207849	1245043	-1608	16	1/2-14	43,0	24,5	32,0	33,0	24,0	30,0	14,0
1207850	1245044	-2012	20	3/4-14	48,0	26,5	42,0	37,0	27,0	36,0	16,0
1244910	1245045	-2516	25	1-11	54,0	30,0	48,0	42,0	36,0	46,0	18,0
1244911	1245046	-3020	30	1 1/4-11	62,0	35,5	54,0	49,0	41,0	50,0	20,0
1244912	1245047	-3824	38	1 1/2-11	72,0	41,0	61,0	57,0	50,0	60,0	22,0

Dimensions shown may be changed without prior notice

// BUTT WELD

// R1A11M100S

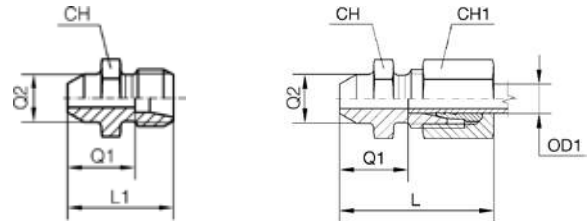
**Butt Weld straight coupling DIN 24° -
Light series**

Item Code Body Only	Item Code Complete	Head mm	OD1 mm	Q1 mm	Q2 mm	CH mm	CH1 mm	L mm	L1 mm
1211088	1243708	-0600	6	14,0	10,0	12,0	14,0	29,0	21,0
1211089	1243709	-0800	8	16,0	12,0	14,0	17,0	31,0	23,0
1211090	1243710	-1000	10	18,0	14,0	17,0	19,0	33,0	25,0
1211091	1243711	-1200	12	18,0	16,0	19,0	22,0	33,0	25,0
1211092	1243712	-1500	15	22,0	19,0	22,0	27,0	37,0	29,0
1211093	1243713	-1800	18	23,5	22,0	27,0	32,0	40,0	31,0
1211094	1243714	-2200	22	28,5	27,0	32,0	36,0	45,0	36,0
1211095	1243715	-2800	28	30,5	32,0	41,0	41,0	47,0	38,0
1211096	1243716	-3500	35	32,5	40,0	46,0	50,0	54,0	43,0
1210752	1243717	-4200	42	35,0	46,0	55,0	60,0	58,0	46,0

// R1A12M100S

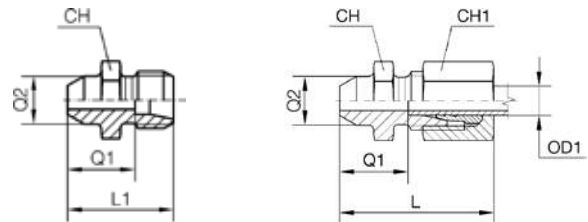
**Butt Weld straight coupling DIN 24° -
Heavy series**

Item Code Body Only	Item Code Complete	Head mm	OD1 mm	Q1 mm	Q2 mm	CH mm	CH1 mm	L mm	L1 mm
1211265	1244047	-0600	6	19,0	11,0	14,0	17,0	34,0	26,0
1211266	1244048	-0800	8	21,0	13,0	17,0	19,0	36,0	28,0
1208074	1244049	-1000	10	22,5	15,0	19,0	22,0	39,0	30,0
1206144	1244050	-1200	12	24,5	17,0	22,0	24,0	41,0	32,0
1211267	1244051	-1400	14	27,0	19,0	24,0	27,0	45,0	35,0
1211268	1244052	-1600	16	26,5	21,0	27,0	30,0	45,0	35,0
1207100	1244053	-2000	20	29,5	26,0	32,0	36,0	51,0	40,0
1208075	1244054	-2500	25	32,0	31,0	41,0	46,0	56,0	44,0
1211269	1244055	-3000	30	35,5	36,0	46,0	50,0	62,0	49,0
1207132	1244056	-3800	38	38,0	44,0	55,0	60,0	69,0	-

// R1A11M11S

Butt Weld long straight coupling DIN 24° - Light series

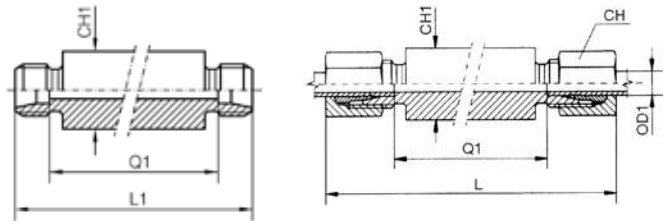

Item Code Body Only	Item Code Complete	Head 1 / Head 2	OD1	Q1	CH	CH1	L	L1
		mm	mm	mm	mm	mm	mm	mm
1211098	1243787	-0606	6	56,0	14,0	18,0	85,0	70,0
1211099	1243788	-0808	8	56,0	17,0	20,0	85,0	70,0
1211100	1243789	-1010	10	58,0	19,0	22,0	87,0	72,0
1211101	1243790	-1212	12	58,0	22,0	25,0	87,0	72,0
1207460	1244547	-1515	15	70,0	27,0	28,0	100,0	84,0
1211102	1243791	-1818	18	69,0	32,0	32,0	101,0	84,0
1211103	1243792	-2222	22	73,0	36,0	36,0	105,0	88,0
1211104	1243793	-2828	28	73,0	41,0	40,0	106,0	88,0
1211105	1243794	-3535	35	71,0	50,0	50,0	114,0	92,0
1211106	-	-4242	42	70,0	60,0	60,0	115,0	92,0

// R1A12M12S

Butt Weld long straight coupling DIN 24° - Heavy series

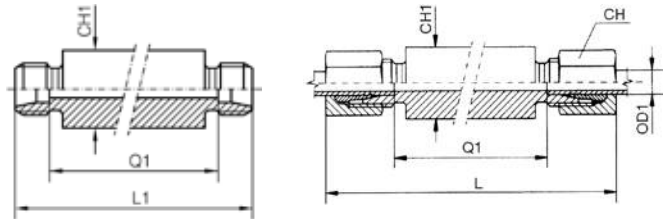

Item Code Body Only	Item Code Complete	Head 1 / Head 2	OD1	Q1	CH	CH1	L	L1
		mm	mm	mm	mm	mm	mm	mm
1211271	1244135	-0606	6	60,0	17,0	20,0	89,0	74,0
1211272	1244136	-0808	8	60,0	19,0	22,0	89,0	74,0
1208076	1244137	-1010	10	59,0	22,0	25,0	91,0	74,0
1211273	1244138	-1212	12	59,0	24,0	28,0	91,0	74,0
1211274	1244139	-1414	14	72,0	27,0	30,0	107,0	88,0
1211275	1244140	-1616	16	71,0	30,0	35,0	107,0	88,0
1207467	1242452	-2020	20	71,0	36,0	38,0	114,0	92,0
1211276	1244141	-2525	25	72,0	46,0	45,0	120,0	96,0
1211277	1244142	-3030	30	73,0	50,0	50,0	126,0	100,0
1211278	1244143	-3838	38	72,0	60,0	60,0	133,0	104,0

Dimensions shown may be changed without prior notice

// PLUG

// R1A15F0000

Plug with O-Ring 24° DIN 2353 - Light series

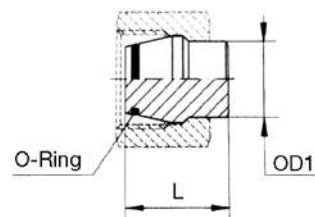

Item Code	Head mm	OD1 mm	L mm
1208264	-0600	6	18,5
1208263	-0800	8	18,5
1208262	-1000	10	20,0
1208240	-1200	12	20,5
1208142	-1500	15	20,5
1208143	-1800	18	22,5
1208146	-2200	22	25,0
1208148	-2800	28	25,5
1208149	-3500	35	30,0
1208150	-4200	42	30,0

// R1A16F0000

Plug with O-Ring 24° DIN 2353 - Heavy series

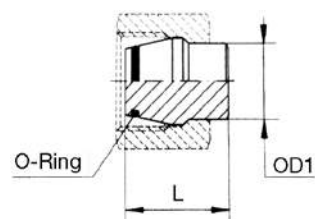

Item Code	Head mm	OD1 mm	L mm
1208239	-0600	6	18,5
1208238	-0800	8	18,5
1208237	-1000	10	20,0
1208236	-1200	12	20,5
1208062	-1400	14	22,5
1208063	-1600	16	23,5
1208064	-2000	20	28,5
1208065	-2500	25	29,0
1208066	-3000	30	30,5
1208067	-3800	38	33,0

// R1A50I0000

Socket head plug Metric cylindric with elastomer

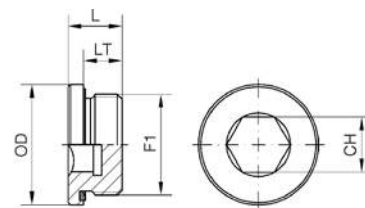

Item Code	Head	F1	OD	CH	L	LT
			mm	mm	mm	mm
1204050	-1000	M10X1.0	13,9	5,0	12,0	8,0
1206352	-1200	M12X1.5	16,9	6,0	17,0	12,0
1204051	-1400	M14X1.5	18,9	6,0	17,0	12,0
1204052	-1600	M16X1.5	21,9	8,0	17,0	12,0
1204053	-1800	M18X1.5	23,9	8,0	17,0	12,0
1204054	-2000	M20X1.5	25,9	10,0	19,0	14,0
1204055	-2200	M22X1.5	26,9	10,0	19,0	14,0
1204056	-2600	M26X1.5	31,9	12,0	21,0	16,0
1204057	-2700	M27X2	31,9	12,0	21,0	16,0
1206706	-3300	M33X2.0	39,9	17,0	22,5	16,0
1211886	-4200	M42X2	49,9	22,0	22,5	16,0
1207864	-4800	M48X2.0	54,9	24,0	22,5	16,0

// R1A06I0000

Socket head plug BSPP cylindric with elastomer

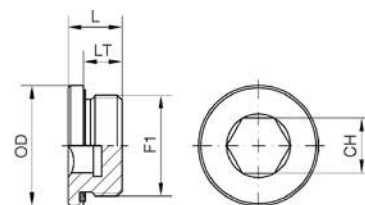

Item Code	Head	F1	OD	CH	L	LT
			mm	mm	mm	mm
1204044	-0200	1/8-28	13,9	5,0	12,0	8,0
1204043	-0400	1/4-19	18,9	6,0	17,0	12,0
1204049	-0600	3/8-19	21,9	8,0	17,0	12,0
1204042	-0800	1/2-14	26,9	10,0	19,0	14,0
1204048	-1200	3/4-14	31,9	12,0	21,0	16,0
1204045	-1600	1-11	39,9	17,0	22,5	16,0
1204047	-2000	1 1/4-11	49,9	22,0	22,5	16,0
1204046	-2400	1 1/2-11	54,9	24,0	22,5	16,0

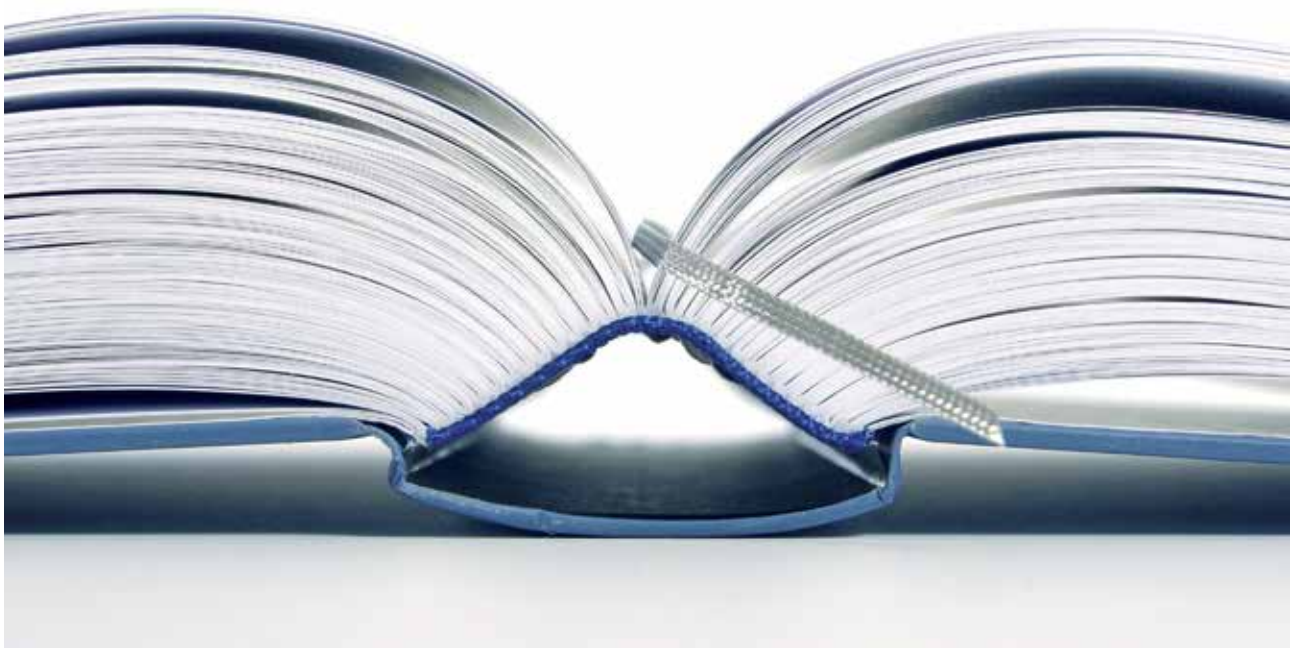

// APPENDIX

// HOSE GUIDELINES	332
// FITTINGS GUIDELINES	344

// ADAPTERS GUIDELINES	358
------------------------------	-----

// HOSE GUIDELINES

SETTING NEW STANDARD

ALFAGOMMA cares for the environment and for your equipment among ALFAGOMMA's newest products are ALFATECH 4000, 5000, 6000 spiral hose, low temperature, Temp Tech, MineTuff, SuperTuff hose and a complete coupling line (two pieces and precrimped ALFACRIMP systems). They join the extensive range of ALFAGOMMA hose, the high pressure hydraulic components that have set the standard for reliability and durability.

DESIGN

Throughout the world ALFAGOMMA has build up a name synonymous with quality, a reputation based on first class product, a commitment to research and development and ongoing capital investment.

The development and product engineering staff in ALFAGOMMA, continue to provide fluid conveying product innovations that assure better performance and cost saving to our customers.

ALFAGOMMA hose and couplings are designed to work together as a system for problem free performance, no matter what machine you operate. The performance of all our product exceeds SAE, DIN, JIS requirements and some hoses meet the MSHA and LOBA flame resistance requirements, as well.

LEADERSHIP IN HYDRAULIC HOSE AND COUPLING COMPONENTS

ALFAGOMMA has developed into a world leading manufacturer, of fluid power and fluid system components. A positive attitude towards the demands from new equipment which is using the latest technology has seen ALFAGOMMA introduce many outstanding new hydraulic hose types. These hoses have found acceptance in a wide range of industry, some examples are:

Mining	Earthmoving	Moulding
Logging	Agriculture	Drilling
Petroleum	Waste/Refuse	Crane
Railroad	Manufacturing	
Construction	Pulp and Plywood Mills	

GLOBAL COMPANY

Due to our world-wide organisation of subsidiaries and distributors you will always be near a source for ALFAGOMMA products. Your ALFAGOMMA dealer has trained personnel to consult with you on your hose and coupling requirements guaranteeing consistent quality and performance.

OUR COMMITMENT

By remaining alert to customer's needs, ALFAGOMMA is constantly engineering new products for tomorrow's markets as well as modifying them for even higher performances. ALFAGOMMA commitment to innovation and service makes our products known throughout the world for quality, reliability and leadership, when you need quality hose and couplings, use the best available.

Now you can count on ALFAGOMMA for all your needs.

TESTING

ALFAGOMMA laboratories are fully equipped to carry out tests according to standards like SAE, ISO, DIN and JIS. New products are also subjected to laboratory simulation of actual service prior to being released on the market.

WORLD CLASS QUALITY

ALFAGOMMA is working to internationally recognised quality programs requiring stringent standards. Many of our customers are demanding ISO qualification or equivalent as a prerequisite for purchasing. This standard is an assurance of consistent quality.

For ALFAGOMMA this is just the start "do it right from the beginning".

IMPORTANT NOTE FOR USERS

Hose assemblies require caution in use not only to provide long service life but also to guard against potentially dangerous failure.

Serious injury, death and destruction of property can result from the rupture or blowing-apart of a hydraulic hose assembly that is damaged, worn out, badly assembled or installed incorrectly.

Users should follow good maintenance practices. Avoid expensive downtime by establishing a program of inspection, testing and replacement of hose assemblies before failure occurs; taking into account factors including: severity of application, frequency of equipment use, past performance of hose assemblies. Document your maintenance, inspections and testing.

Only properly trained persons should inspect, test or service hose assemblies and this training should be updated regularly. Users should carefully observe the precautions listed below under "**be aware that**" as well as following closely our recommendations for the selection of hose and couplings. In addition, care should be taken not to exceed the minimum bend radius listed for each hose size and type. Maximum operating pressure should not exceed the pressures listed. Instruction for assembling fittings to different hoses should be followed carefully to ensure the safe performance of the complete assembly.

By following the recommendations on hose assembly routing and installation, improved safety and longer service life of any hose installation will result.

Hydraulic fluid under pressure can be potentially dangerous!! An explosive burst or stream of escaping fluid can cause damage to equipment as well as serious injury to persons nearby.

BE AWARE THAT...

1. Highly pressurised fluid escaping from a small pinhole can be almost invisible and, yet, exert extreme force capable of penetrating the skin and other body tissues, causing possible severe injury.
2. Hot fluids or chemicals can cause severe burns.
3. Pressurised fluids, if released uncontrolled, can exert a tremendous explosive force.
4. All hydraulic hoses listed in this catalogue are electrically conductive.
5. Some hydraulic fluids are highly flammable.

AND...

6. Always position a shield between you and any pressurised hydraulic lines when working next to them... or shut the pressure off.
7. Wear safety glasses.
8. Do not use your hands to check for leaks. Do not touch a pressurised hydraulic hose assembly with any part of your body, if fluid punctures the skin, even if no pain is felt, a serious emergency exists. Obtain medical assistance immediately. Failure to do so can result in loss of the injured body part or death.
9. Stay out of hazardous areas while testing hose assemblies under pressure. Use proper safety protection.
10. If an injury or reaction occurs, get medical attention right away.
11. Use only non conductive thermoplastic hoses where electrical conductivity is not desired: for instance, equipment working on electric power lines.

ALFAGOMMA hose and fitting are designed, engineered and tested to be used together in an assembly.

The use of ALFAGOMMA fittings on other manufactures hose or the use of ALFAGOMMA hose with other manufactures fittings may result in the production of unreliable or unsafe assemblies. It is neither recommended nor authorised by ALFAGOMMA.

ALFAGOMMA recommends only those hose and coupling combinations specified in the ALFAGOMMA Hydraulic Products Catalogues.

ALFAGOMMA disclaims any liability for any hose assemblies which have not been produced in conformance with ALFAGOMMA assembly recommendations and current crimp data charts.

Extensive impulse testing has been performed by ALFAGOMMA to verify the recommendations contained in this catalogue. A simple burst or pressure test cannot determine a hose and coupling combination.

Any claim for defects must be made in writing on the appropriate ISO 9001 complaint form within 8 days from receipt of the product. ALFAGOMMA will have a reasonable opportunity thereafter to examine and investigate the alleged defect.

The customer's exclusive remedy with respect to any claim of any kind whatsoever shall be refund of the purchase price or replacement of the product at the option of ALFAGOMMA and in no event shall ALFAGOMMA be liable for any incidental or consequential damages whatsoever.

REFERENCE SPECIFICATIONS

SAE -	Society of Automotive Engineers	LOBA -	Landesobergamt Nordrhein - Westfalen
DNV - GL	Det Norske Veritas - Germanischer Lloyd	AS -	Australian Standard
EN -	European Norm	BV -	Bureau Veritas
DIN -	Deutsche Institute Normen	ISO -	International organization for Standardization
CERCHAR -	Centre d'Etudes et Recherches Des Charbonnages de France	KR -	Korean Register
MSHA -	U.S. Mine Safety and Health Administration	MA -	Chinese Mining

The listing below are intended only as guides in identifying which ALFAGOMMA hoses comply with requirements of various agencies.

Hose	SAE J517	EN	ISO	Alfagomma Proprietary Hose	DNV GL	ABS	BV	NKK	RINA	Lloyd's Register	MSHA ²	USDOT ³	KR	MA
Flexor 1TE/R6 HF	100 R6	854 R6												
Flexor 2TE HF		854 2TE												
Flexor 3TE/R3 HF	100 R3	854 3TE												
Flexor R4	100 R4						X							
Flexor 5	100 R5											X		
Flexor 7	100 R7	855 R7	3949											
Flexor 8	100 R8	855 R8												
Flexor 1SN-R1AT HF	100 R1AT	853 1SN	1436		X	X							X	
Flexor 1SN-R1AT MT	100 R1AT	853 1SN			X	X					X			
Flexor 1ST-R1AT	100 R1A	853 1ST	1436		X	X	X	X	X	X	X		X	
Flexor 2SN-R2AT HF	100 R2AT	853 2SN	1436		X	X							X	
Flexor 2SN-R2AT MT	100 R2AT	853 2SN			X	X					X			X
Flexor 2ST-R2AT	100 R2A	853 2ST	1436		X	X	X	X	X	X	X		X	
Flexopak PLT				X										
Flexopak 1SC		857 1SC	11237		X		X							
Flexopak 2	100 R16	857 2SC	11237		X				X		X		X	
Flexopak 2SC HF	100 R16	857 2SC	11237		X	X	X							X
Flexor 4SP		856 4SP			X	X	X	X	X		X			X
Flexor 4SH		856 4SH			X	X	X	X	X	X	X		X	X
Flexor R12	100 R12	856 R12			X	X		X	X		X			
Flexor R13	100 R13	856 R13			X	X	X	X	X	X	X		X	X
Flexor R15	100 R15				X	X	X		X					X
Alfabiotech 2000			18752								X			
Alfabiotech 3000	EX SAE R12		18752	X	X*					X*	X			
Alfabiotech 4000			18752	X	X	X				X*	X			
Alfabiotech 5000			18752	X	X	X				X*	X			
Alfabiotech 5000P			18752	X	X	X				X*	X			
Alfabiotech 6000	EX SAE R15		18752	X	X	X	X			X*	X			
Firesafe 5000				X							X*			
Alfatech 3000	100 R17	857 Ø 3/8"	11237	X		X					X			
Alfatech 7000				X							X			
Alfatech 8000				X							X			
Flexopak 2 HT	100 R16	857 2SC	11237											
Temp Tech 1SN	100 R1AT	853 1SN	1436	X	X	X*								
Temp Tech 2SN	100 R2AT	853 2SN	1436	X										
Flexopak 2 LT	100 R16	857 2SC		X										
Alfaforest				X										
Flexor 4SP LT		856 4SP		X										
Flexor 4SH LT		856 4SH		X										
Alfajet 210				X										
Alfajet 400				X										

1. DNV approvals are with permanent (crimp) type fittings only
2. Hoses with MSHA approved cover are always branded "MSHA"
3. DOT Type All TYPE All FMVSS 106 approval up to size -12

Listing may vary by style and size, for current and complete information, contact ALFAGOMMA for details.

* Running

SAFETY GUIDE BASIC FACTORS FOR THE SELECTION, INSTALLATION AND MAINTENANCE OF HOSE AND HOSE ASSEMBLIES

Hydraulic hose (and hose assemblies) has a limited life dependent on service conditions to which is applied.

Subjecting hose (and hose assemblies) to conditions more severe than the recommended limits significantly reduce service life. Exposure to combinations of recommended limits (i.e., continuous use at maximum rated working pressure, maximum recommended operating temperature and minimum bend radius) will also reduce service life.

WARNING: FAILURE TO FOLLOW PROPER SELECTION, INSTALLATION AND MAINTENANCE PROCEDURES BODILY INJURY, AND DAMAGE TO PROPERTY.

1. SELECTION

The following is a list of factors which must be considered before the selection of a hose can be made:

1.1 Line size

In order to achieve maximum efficiency in a hydraulic system, it is necessary to keep pressure losses (resistance to the volumetric flow) to a minimum when a fluid is conveyed by the different types of flow lines.

When a fluid flows through a flow line, heat is generated by friction. Thus part of the energy is lost as heat energy, which results in a pressure loss.

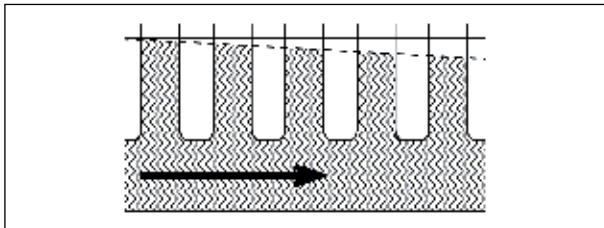

These pressure losses depend upon:

- flow velocity (for a given volumetric flow, the fluid flow velocity increases with a decrease in the cross sectional area of a flow line and vice versa)
- length of the flow line
- the viscosity of the fluid flowing
- the density of the fluid flowing
- the type of flow (laminar or turbulent)

Types of flow - The type of flow changes from laminar to turbulent at a certain flow velocity. This velocity is given by the Reynold's Number Re .

For cylindrical flow lines the following formula applies:

$$Re = \frac{v \times d}{\nu}$$

where: v = velocity (m/s)
 d = flow line internal dia (m)
 ν = kinematic viscosity (m²/s)

As soon as the value for Re exceeds 2300, the laminar flow changes to turbulent flow.

Laminar flow - In laminar flow, the individual fluid particles move up to certain speeds in uniform layers alongside each other. They scarcely disturb or influence each other.

Turbulent flow - If the value for Re exceeds 2300, flow becomes whirling and turbulent. The individual particles no longer move in one direction in an orderly fashion, but influence and hinder each other.

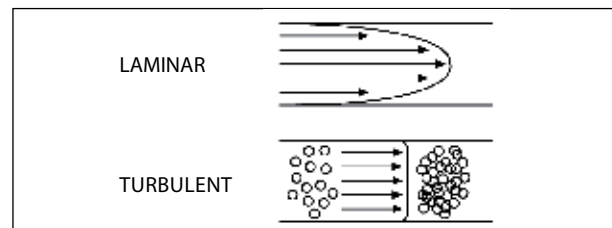

Certain fluid flow velocities have proved to be most suitable for hydraulic flow lines.

Recommended flow velocities:

Suction lines:	0.5 ... 1.2 m/s	1.6 ... 4 feet/s
Return lines:	2 ... 3 m/s	6.5 ... 10 feet/s
Pressure lines:	4 ... 7.5 m/s	13...25 feet/s

FLOW CAPACITY NORMOGRAM

Flow Capacities of Hose at Recommended Flow Velocities
 The chart below is provided as an aid in the determination of the correct hose size.

Example at 45 l/min, what is the proper hose size within the recommended velocity range for pressure lines?

Locate 45 l/min in the left-hand column and 7,5 m/s in the right-hand column (the maximum recommended velocity range for pressure lines).

Lay a straight line across these two points. The inside diameters shown in the centre column is above 9,5 mm so we have to use 12,7 mm (1/2"). For suction hose, follow the same procedure except use recommended velocity range for intake lines in the righthand column.

where: Q = flow in liters per seconds (l/sec)

V = velocity in meters per seconds (m/s)

d = hose inside diameter (mm & dash size)

TECHNICAL INFORMATION – NORMOGRAM OF THE FLOW

The normogram herewith is pivotal to help you find the hose diameter by knowing the liquid flow and speed. In order to find the correct diameter you should trace a line between the flow value (l/min) and the suggested speed (m/sec) according to the kind of delivery (pressure or return). The value touched by the line in the central column will indicate the hose ID (mm/inches) that must be used.

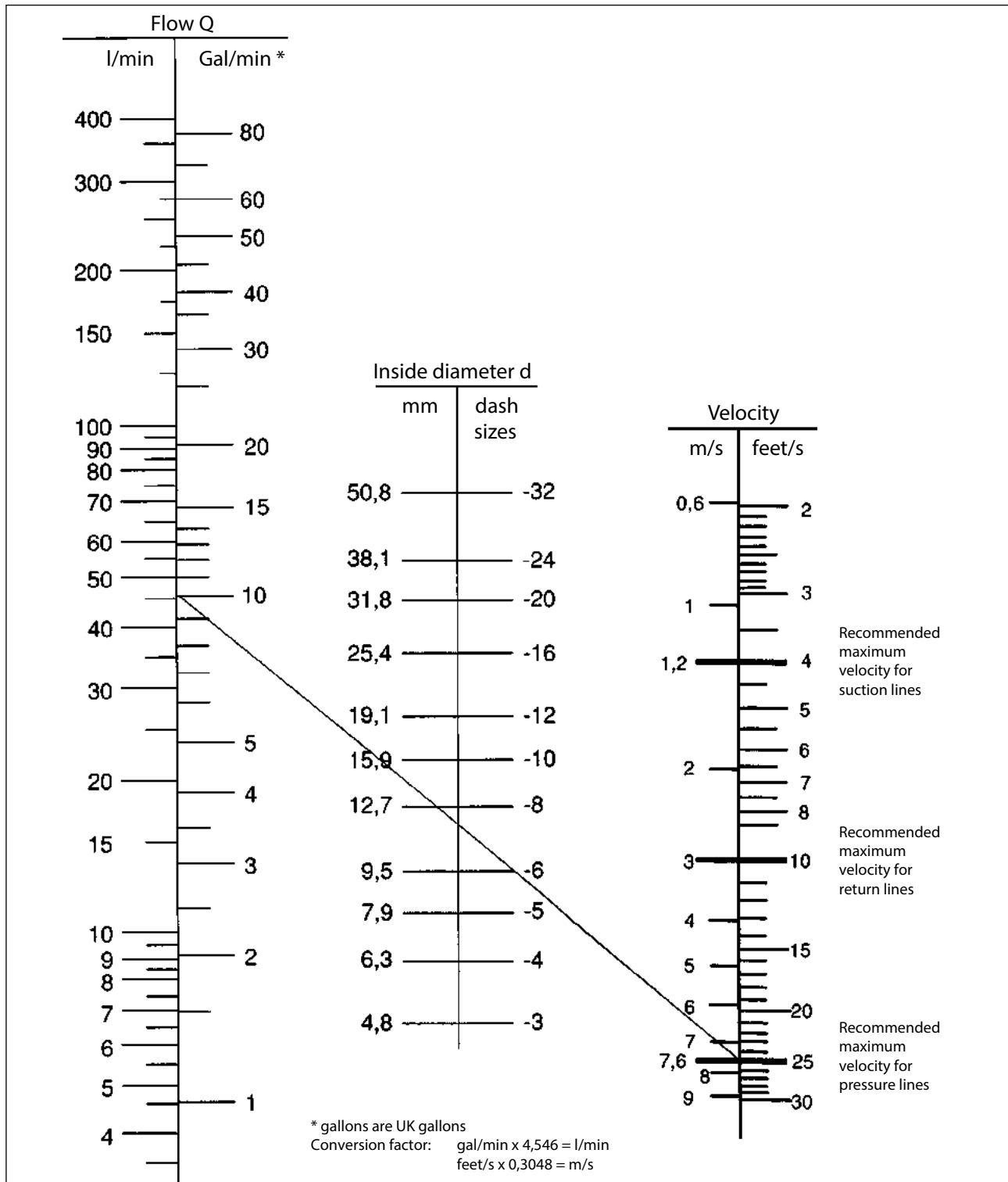

It is therefore important to calculate correctly the required flow line sizes. Undersized pressure lines results in high fluid velocity causing an excessive pressure drop, and heat built up, which impair overall system performance.

Undersized suction lines can cause cavitation at the hydraulic pump inlet, affecting performance, shortening pump life, and creating excessive noise levels.

The flow capacity normogram is an aid to determine the correct hose internal diameter size, desired flow rate and recommended velocity. By the use of any two known factors, the third can be determined.

1.2 Pressure

After determining the system pressure for a hydraulic system, hose selection must be made so that the recommended maximum operating pressure specified by a given hose, is equal or greater than the system pressure. Dynamic pressure is common for all hydraulic systems. Pressure surges which exceed the maximum working pressure (pressure relief valve setting) affect the service life of system components, including a hose assembly and therefore need to be taken into consideration. Hoses used for suction lines must be selected to ensure the hose will withstand the negative pressure of the system.

1.3 Temperature

Care must be taken to ensure that the operating temperature of the fluid being conveyed and ambient temperatures, do not exceed the limitations of the hose. Special care must be taken when routing near hot manifolds or molten metal.

1.4 Fluid Compatibility

Hose selection must assure compatibility of the hose tube, cover, reinforcement, and fittings with the fluid used.

Additional caution must be observed in hose selection for gaseous applications. Some fire resistant fluids require the same hose as petroleum oil. Some use a special hose, while a few fluids will not work with any hose at all.

For gas application, where compatible with Alfacomma Hoses, and at pressure above 10 bar, the hose cover shall be pin-pricked.

1.5 Permeation

Permeation (that is, seepage through the hose) will occur from inside the hose to outside when hose is used with gases, liquid and gas fuels, and refrigerants (including but not limited to such materials such as helium, fuel oil, natural gas or freon). This permeation may result in high concentrations of vapours which are potentially flammable, explosive, or toxic and in loss of fluid. Even though the fluid compatibility is acceptable, you must take into account the fact that permeation will occur and could be hazardous. Permeation of moisture from outside the hose to inside the hose will also occur. If this moisture permeation would have detrimental effects (particularly but not limited to refrigeration and air conditioning systems), incorporation of sufficient drying capacity in the system or other appropriate system safeguards should be selected and used.

1.6 Routing

Attention must be given to optimum routing to minimise inherent problems. Restrain, protect or guide hose with the use of clamps if necessary to minimise risk or damage due to excessive flexing, whipping or contact with other moving parts or corrosives. Determine hose lengths and configurations that will result in proper routing and protection from abrasion, snagging or kinking and provide leak resistant connections.

1.7 Environment

Care must be taken to ensure that the hose and fittings are either compatible with or protected from the environment to which they are exposed. Environmental conditions including but not limited to ultraviolet light, heat, ozone, moisture, water, salt water, chemicals, and air pollutants can cause degradation and premature failure and, therefore, must be considered.

1.8 Mechanical Loads

External forces can significantly reduce hose life. Mechanical loads which must be considered include excessive flexing, twist, kinking, tensile or side loads, bend radius, and vibration. Use of swivel type fittings or adaptors may be required to ensure no twist is put into the hose. Unusual applications may require special testing prior to hose selection.

1.9 Abrasion

While a hose is designed with a reasonable level of abrasion resistance, care must be taken to protect the hose from excessive abrasion which can result in erosion, snagging, and cutting of the hose cover. Exposure of the reinforcement will significantly accelerate hose failure.

1.10 Proper End Fitting

Care must be taken to ensure proper compatibility exists between the hose and coupling selected based on the manufacturer's recommendations substantiated by testing to industry standards such as SAE J517, DIN 20024, JIS B 8360.

1.11 Length

When establishing proper hose length, motion absorption, hose length changes due to pressure, as well as hose and machine tolerances must be considered.

1.12 Specifications and Standards

When selecting hose and fittings, government, industry, and manufacturer's specifications and recommendations must be reviewed as applicable.

1.13 Hose Cleanliness

Hose components may vary in cleanliness levels. Care must be taken to ensure that the assemblies selected have an adequate level of cleanliness for the application.

1.14 Welding and Brazing

Heating of plated parts, including hose fittings and adaptors, above 232° C (450° F) such as during welding, brazing, or soldering may emit deadly gases.

1.15 Electrical Conductivity

Certain applications require that a hose be non-conductive to prevent electrical current flow. Other applications require the hose to be sufficiently conductive to drain off static electricity. Extreme care must be exercised when selecting hose and fittings for these or any other applications in which electrical conductivity or non-conductivity is a factor. For applications that require hose to be electrically non-conductive, including but not limited to applications near high voltage electric lines, only special non-conductive hose is to be used. The manufacturer of the equipment in which the non-conductive hose is to be used must be consulted to be certain that the hose and fittings that are selected are proper for the application.

Do not use any ALFAGOMMA hose or fitting for any application requiring non-conductive hose, including but not limited to applications near high voltage electric lines, unless the application is expressly approved in the ALFAGOMMA technical publication for the product, the SAFETY GUIDE hose is both orange in colour and marked "non-conductive", and the manufacturer of the equipment on which the hose is to be used specifically approves the particular ALFAGOMMA hose and fitting for such use.

ALFAGOMMA does not supply any hose or fittings for conveying paint in airless paint spraying or similar applications and therefore should not be used. A special hose and fitting assembly is required for this application, to avoid static electricity buildup which could cause a spark that may result in an explosion and/or fire.

The electrical conductivity or non-conductivity of hose and fittings is dependant upon many factors and may be susceptible to change. These factors include but are not limited to the various materials used to make the hose and the fittings, manufacturing methods (including moisture control), how the fittings contact the hose, age and amount of deterioration or damage or other changes, moisture content of the hose at and particular time, and others factors.

2. INSTALLATION

After the selection of the correct hose, the following factors must be considered prior to hose and fitting assembly and installation.

2.1 Pre-Installation Inspection

Prior to installation, a careful examination of the hose must be performed. All components must be checked for correct style, size, and length. The hose must be examined for cleanliness, obstructions, blisters, cover looseness, or any other visible defects.

2.2 Hose and Fitting Assembly

Do not assemble an ALFAGOMMA fitting on an ALFAGOMMA hose that is not specified by ALFAGOMMA for that hose. Do not assemble ALFAGOMMA fittings on another manufacturer's hose or an ALFAGOMMA hose on another manufacturer's fitting unless ALFAGOMMA approves the assembly in writing, and the user verifies the assembly and the application through analysis and testing.

The ALFAGOMMA published hose assembly instructions must be followed for assembling the fittings on the hose.

2.3 Related Accessories

Crimp or swage ALFAGOMMA hose or fittings only with ALFAGOMMA approved swage or crimp machines and in accordance with the ALFAGOMMA published hose assembly instructions.

2.4 Parts:

Do not use any ALFAGOMMA hose fitting part (including but not limited to sockets, or inserts) except with the correct ALFAGOMMA mating parts, in accordance with ALFAGOMMA published hose assembly.

2.5 Reusable/Permanent

Do not reuse any reusable hose coupling that has blown or pulled off a hose. Do not reuse an ALFAGOMMA permanent (that is, crimped or swaged) hose fitting or any part thereof.

2.6 Minimum Bend Radius

Installation of a hose at less than the minimum listed bend radius may significantly reduce the hose life. Particular attention must be given to avoid sharp bending at the hose/fitting juncture.

2.7 Twist Angle and Orientation

Hose installations must be such that relative motion of machine components does not produce twisting.

2.8 Securement

In many applications, it may be necessary to restrain, protect, or guide the hose to protect it from damage by unnecessary flexing, pressure surges, and contact with other mechanical components. Care must be taken to ensure such restraints do not introduce additional stress or wear points.

2.9 Proper Connection of Ports

Proper physical installation of the hose requires a correctly installed port connection while ensuring that no twist or torque is transferred to the hose.

2.10 External Damage

Proper installation is not complete without ensuring that tensile loads, side loads, kinking, flattening, potential abrasion, thread damage, or damage to sealing surfaces are corrected or eliminated.

2.11 System Checkout

After completing the installation all air entrapment must be eliminated and the system pressurised to the maximum system pressure and checked for proper function without any leaks. Personnel must stay out of potential hazardous areas while testing.

3. HOSE AND FITTING MAINTENANC INSTRUCTIONS

Even with proper selection and installation, hose life may be significantly reduced without a continuing maintenance program. Frequency should be determined by the severity of the application and risk potential. A maintenance program must be established and followed to include the following as a minimum:

3.1 Visual Inspection Hose/Fitting

Any of the following conditions require immediate shut down and replacement of the hose assembly:

- Fitting slippage on hose.
- Damaged, cut or abraded cover (any reinforcement exposed).
- Hard, stiff, heat cracked, or charred hose.
- Cracked, damaged, or badly corroded fittings.
- Leaks at fitting or in hose.
- Kinked, crushed, flattened or twisted hose.
- Blistered, soft, degraded, or loose cover.

3.2 Visual Inspection All Other

The following items must be tightened, repaired or replaced as required:

- Leaking port conditions
- Remove excess dirt build-up
- Clamp, guards, shields
- System fluid level, fluid type and any air entrapment

3.3 Functional Test

Operate the system at maximum operating pressure and check for possible malfunctions and freedom from leaks. Personnel must stay out of potential hazardous areas while testing.

3.4 Replacement Intervals

Specific replacement intervals must be considered based on previous service life, government or industry recommendations, or when failures could result in unacceptable downtime, damage, or injury risk.

CORRECT ASSEMBLY INSTALLATION

Satisfactory performance and appearance depend upon proper hose installation. Excessive length destroys the trim appearance of an installation and adds unnecessarily to the cost of the equipment. Hose assemblies of insufficient length to permit adequate flexing, expansion or contraction will cause poor power transmission and shorten the life of the hose.

The diagrams below offer suggestions for proper hose installations to obtain the maximum in performance and economy.

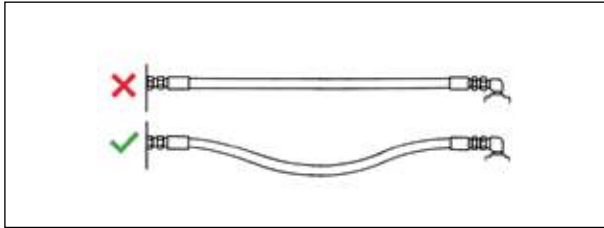

Since hose may change in length from +2% to -4% under the surge of high pressure, provide sufficient slack for expansion and contraction.



Avoid sharp twist or bend in hose by using proper angle adapters.

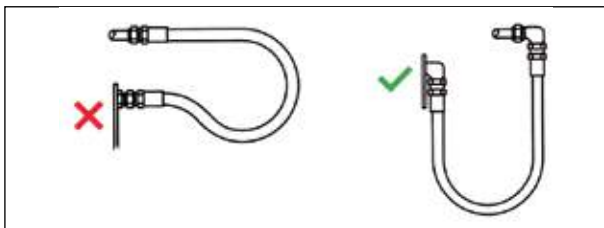

Where the radius falls below the required minimum, an angle adapter should be used as shown above to avoid sharp bends in hose.

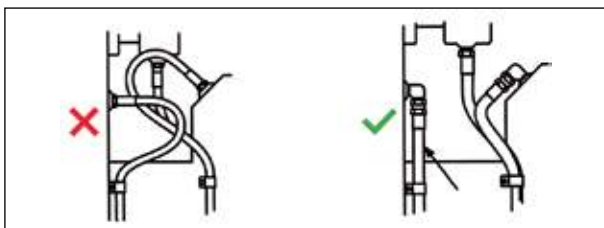

Obtain direct routing of hose through use of 45° and 90° adapters and fittings. Improve appearance by avoiding excessive hose length.

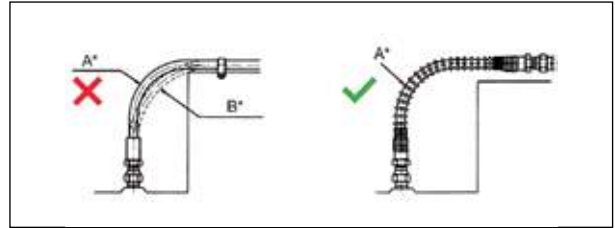

A: High Pressure - B: No Pressure

Due to changes in length when hose is pressurised, do not clamp at bends so curves absorb changes and protect the hose with a spring guard. Do not clamp high and low pressure lines together and protect the hose with a spring guard.

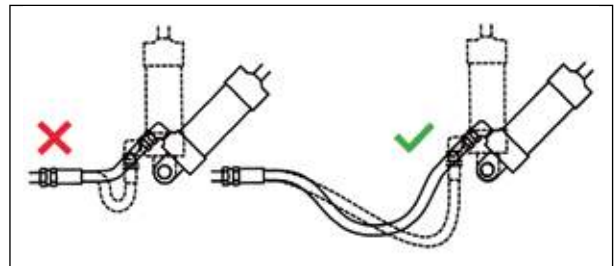

Adequate hose length is most important to distribute movement on flexing applications and to avoid abrasion.

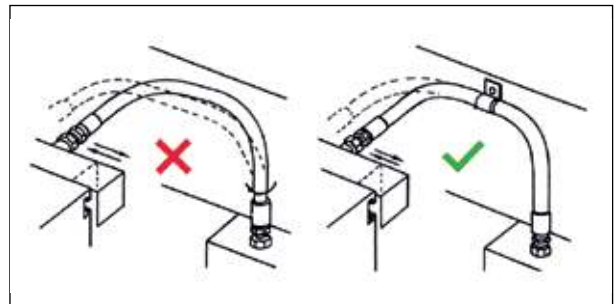

To avoid twisting in hose lines bent in two planes, clamp hose at change of plane, as shown.

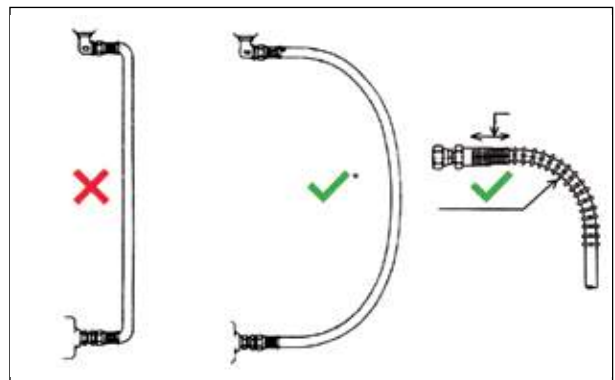

* Never use a banding radius less than the minimum amount shown in the table.

To prevent twisting and distortion, hose should be bent in the same plane as the motion of the boss to which the hose is connected.

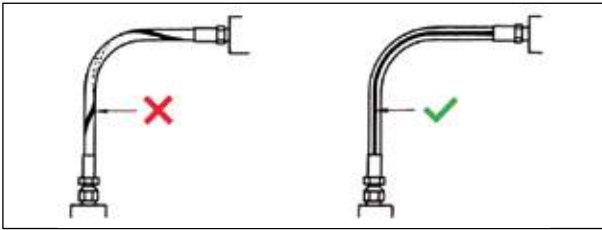

Hose should not be twisted. Hose is weakened when installed in twisted position. Also pressure in twisted hose tends to loosen fitting connections. Design so that machine motion produces bending rather than twisting.

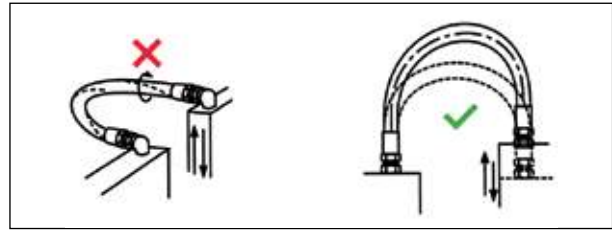

Never use a bending radius less than the minimum shown in the hose specification tables. Avoid sharp bend in hose to reduce collapsing of line and restriction of flow by using proper spring guard. Exceeding minimum bend radius will greatly reduce hose assembly life.

HOW TO DETERMINE CORRECT ASSEMBLY LENGTH

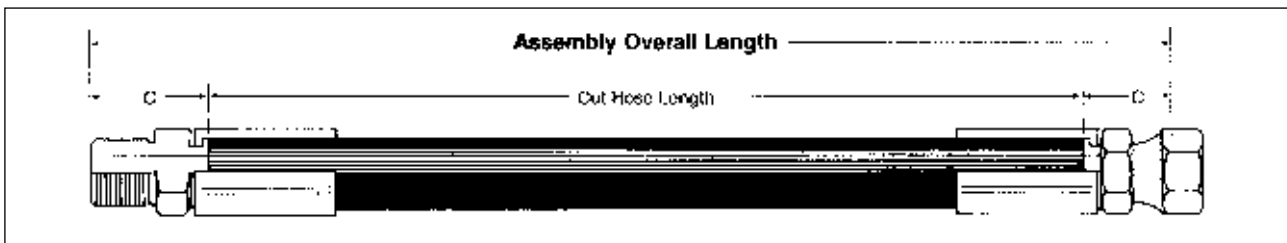

For most assemblies, the correct assembly length may be determined by direct measurement of the equipment or a drawing. Minimum bend radii as shown in the hose specification tables should be observed. Assemblies are measured to the end of the seal.

To determine the length of hose needed in making assemblies with permanent or reusable couplings, subtract Dimension "C" (Cut off factor) for each coupling from the required overall assembly length. Dimension "C" may be found in the coupling specification tables.

HOW TO MEASURE ASSEMBLIES

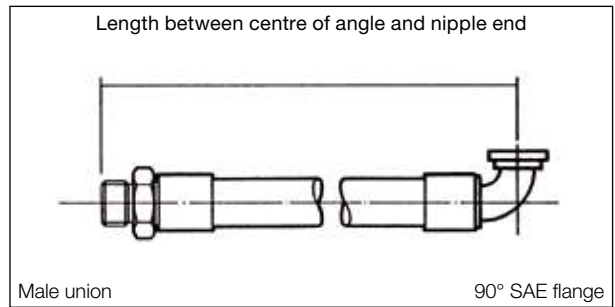
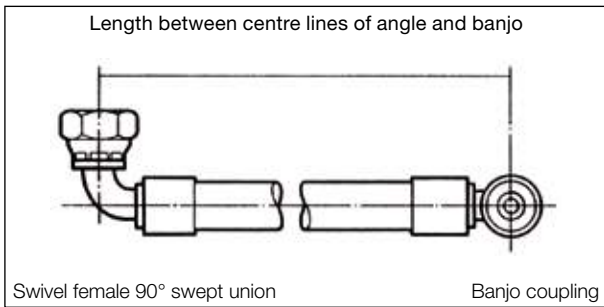
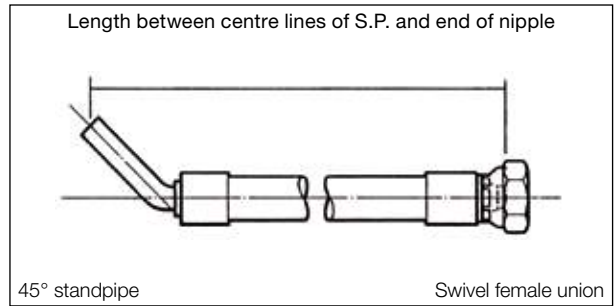
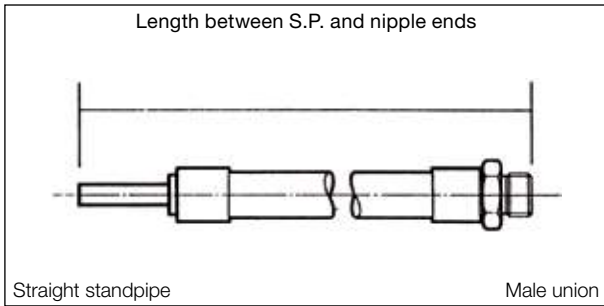
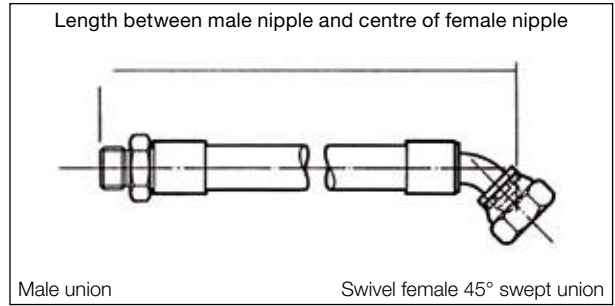
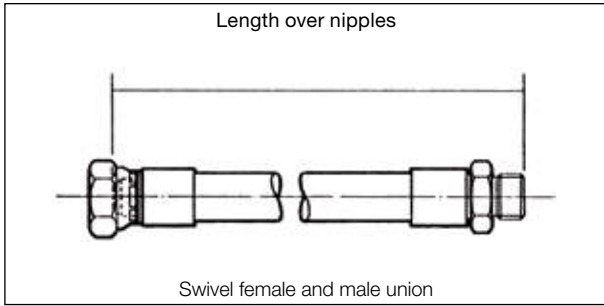

Remember that hydraulic hose under pressure will elongate up to 2% of its length or contract up to 4% depending on pressure, type and size. Sufficient allowance should be made to permit such changes in length.

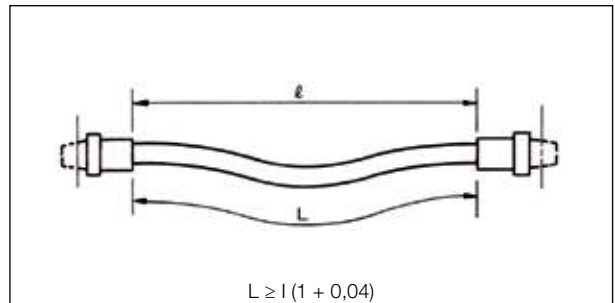

Occasionally an assembly will be required similar to the sketches to the right. The following equations are helpful in determining the correct length:

FOR 180° TURN APPLICATIONS

$$\#1 L = 2A + \pi R$$

$$\#2 L = 2A + \pi R + T$$

where:

L=overall length of the hydraulic hose assembly, in mm or inches.

A=allowance for a minimum straight section of hydraulic hose at each end of the assembly, measured from the outer end of each coupling, in mm or inches. These two straight sections are necessary to prevent excessive stress concentrations directly back of the couplings. See table below.

R=bending radius of the hose, in mm or inches. See hose specifications tables.

T=amount of travel, in mm or inches.

Often right angle adapters provide a convenient means of avoiding too small a bend radius.

Hose ID	in	1/4	5/16	3/8	1/2	5/8	3/4	1	1.1/4	1.1/2	2
	mm	6,4	7,9	9,5	12,7	15,9	19	25	31,8	38,1	50,8
Min "A"	in	5	5	5	6	6	7	8	9	10	11
	mm	127	127	127	152	152	178	203	229	254	279

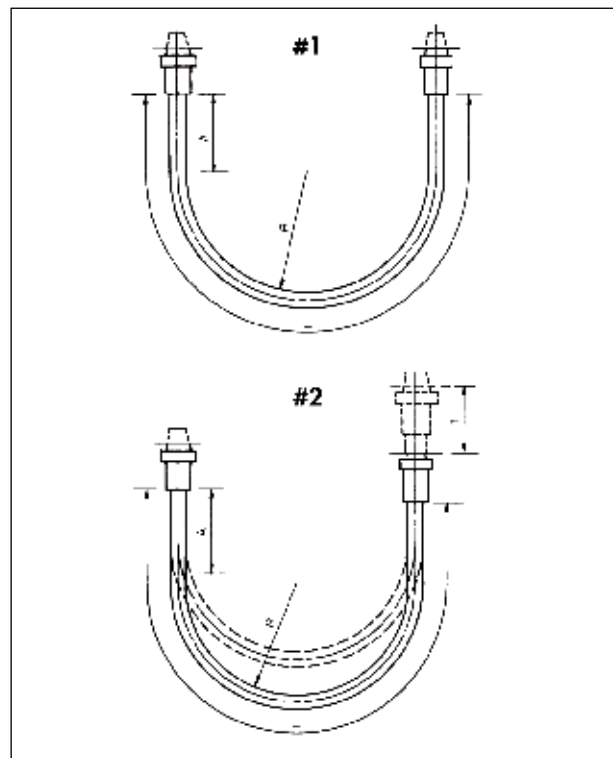

Length Tolerance for Hydraulic Hose Assemblies and Specified Hose Lengths

Length

For lengths from 0 up to and including 12" (305 mm)

For lengths ≥ 12" (305 mm) < 18" (457 mm)

For lengths ≥ 18" (457 mm) < 36" (914 mm)

For lengths ≥ 36" (914 mm) < 48" (1219 mm)

For lengths ≥ 48" (1219 mm) < 72" (1830 mm)

For lengths ≥ 72" (1830 mm)

Tolerance

± 1/8" ± 3 mm

± 3/16" ± 5 mm

± 1/4" ± 6 mm

± 3/8" ± 10 mm

± 1/2" ± 13 mm

± 1%

Elbow angle and angle of orientation

Tolerance ±3

Angle Couplings

A - To measure angle of offset of a hose assembly, point one end of coupling "A" (the nearest) to a vertical position downward. The angle can then be measured from the centreline of this vertical coupling in an anticlockwise direction to the centreline of coupling "B" (the far coupling) (see illustration).

Relationships can then be expressed from 0° to 360°. If angle not given elbows are positioned at 0°.

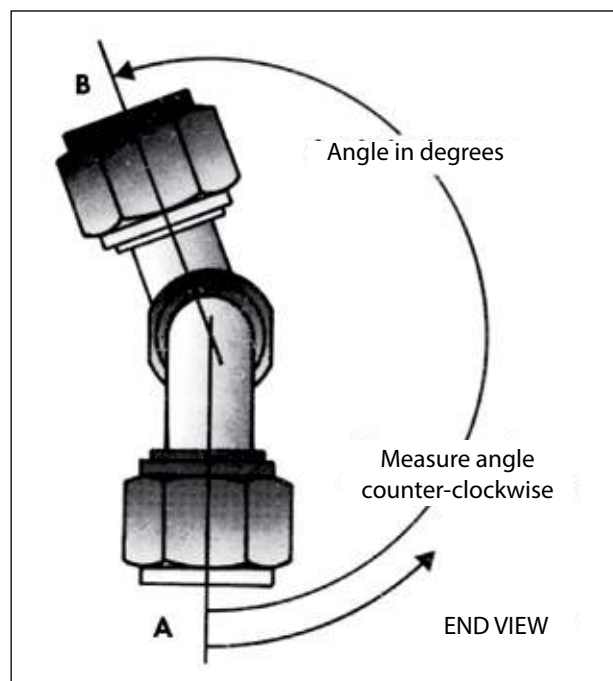

// FITTINGS GUIDELINES

FITTING IDENTIFICATION

Dash numbers

Most fluid piping system sizes are measured by dash numbers. These are universally used abbreviations for the size of component expressed as the numerator of the fraction with the denominator always being 16. For example, a -04 port is 4/16 or 1/4 inch. Dash numbers are usually nominal (in name only) and are abbreviations that make ordering of components easier.

There are many coupling systems used for hydraulic connections. They are identified as:

American, British, French, German, Japanese.

This section lists the origin and coupling style.

Descriptions and dimensional data follows each coupling style.

AMERICANT THREAD TYPES

NPTF (National Pipe Tapered Fuel)

This is a dryseal thread, the National pipe tapered thread for fuels. This is used for both male and female ends. This connection is still widely used in fluid power systems, even through it is not recommended by the National Fluid Power Association (N.F.P.A.) for use in hydraulic applications. The NPTF male will mate with the NPTF, NPSF or NPSM female.

The NPTF male has tapered threads and a 30° inverted seat. The NPTF female has tapered threads and no seat. The seal takes place by deformation of the threads. The NPSM female has straight threads and a 30° inverted seat. The seal takes place on the 30° seat.

The NPTF connector is similar to, but not interchangeable with, the BSPT connector. The thread pitch is different in most sizes. Also, the thread angle is 60° instead of the 55° angle found on BSPT threads.

NPSF (National Pipe Straight Thread for Fuels)

The National pipe straight thread for fuels. This is sometimes used for female ends and properly mates with the NPTF male end. However, the SAE recommends the NPTF thread in preference to the NPSF for female ends.

NPSM (National Pipe Straight Mechanical)

National pipe straight thread for mechanical joint. This is used on the female swivel nut of iron pipe swivel adapters. The leak-resistant joint is not made by the sealing fit of threads, but by a tapered seat in the coupling end. This connection is sometimes used in fluid power systems.

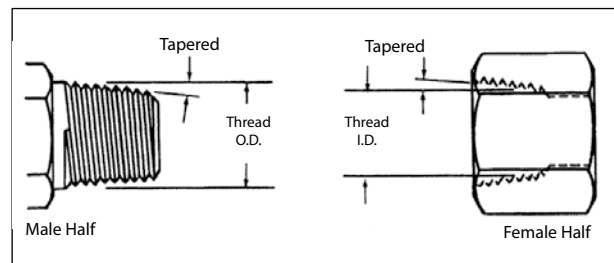

Thread Identification Table

National Pipe Straight Mechanical (NPSM) National Pipe Tapered for Fuels (NPTF)

Dash	Tube Size	Thread Size	Female Thread I.D.		Male Thread O.D.	
	(in)	(in-TPI)	(mm)	(in)	(mm)	(in)
-2	1/8	1/8-27	8.7	0.34	10.3	0.41
-4	1/4	1/4-18	11.9	0.47	14.3	0.56
-6	3/8	3/8-18	15.1	0.59	17.5	0.69
-8	1/2	1/2-14	18.3	0.72	21.4	0.84
-12	3/4	3/4-14	23.8	0.94	27.0	1.06
-16	1	1-11.1/2	30.2	1.19	33.3	1.31
-20	1.1/4	1 1/4-11.1/2	38.9	1.53	42.9	1.69
-24	1.1/2	1 1/2-11.1/2	44.5	1.75	48.4	1.91
-32	2	2 - 11.1/2	57.2	2.25	60.3	2.38

SAE J514 Straight Thread O-Ring Boss (ORB)

This port connection is recommended by the N.F.P.A. for optional leakage control in medium and high pressure hydraulic systems. The O'ring boss male will mate with an O'ring boss female only.

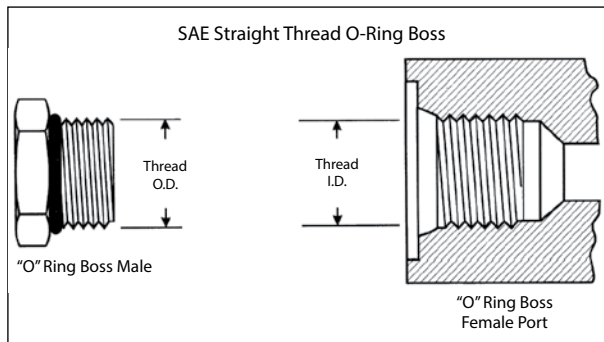

Thread Identification Table

SAE J514 Straight Thread O-Ring Boss

Tube Size	Tube Size	Thread Size	Female Thread I.D.		Male Thread O.D.	
			(mm)	(in)	(mm)	(in)
-2	1/8	5/16-24	6.9	0.27	7.8	0.31
-3	3/16	3/8-24	8.5	0.34	9.4	0.37
-4	1/4	7/16-20	9.9	0.39	11.2	0.44
-5	5/16	1/2-20	11.5	0.45	12.6	0.49
-6	3/8	9/16-18	12.9	0.51	14.1	0.56
-8	1/2	3/4-16	17.5	0.69	18.9	0.74
-10	5/8	7/8-14	20.5	0.81	22.1	0.87
-12	3/4	1.1/16-12	24.9	0.98	26.9	1.06
-14	7/8	1.3/16-12	28.1	1.11	30.3	1.18
-16	1	1.5/161/2	31.3	1.23	33.1	1.31
-20	1.1/4	1.5/8-12	39.2	1.54	41.1	1.62
-24	1.1/2	1.7/8-12	45.6	1.79	47.4	1.87
-32	2	2.1/2-12	61.4	2.42	63.3	2.49

The male has straight threads and an O'ring. The female has straight threads and a sealing face. The seal is made at the O'ring on the male and the sealing face on the female. The threads hold the connection mechanically.

SAE J514 37° (JIC)

The Society of Automotive Engineers (SAE) specifies a 37° angle flare or seat be used with high pressure hydraulic tubing. These are commonly called JIC couplings.

The JIC 37° flare male will mate with a JIC female only.

The JIC male has straight threads and a 37° flare seat.

The JIC female has straight threads and a 37° flare seat.

The seal is made on the 37° flare seat by establishing a line contact between the male flare and the female cone seat. The threads hold the connection mechanically.

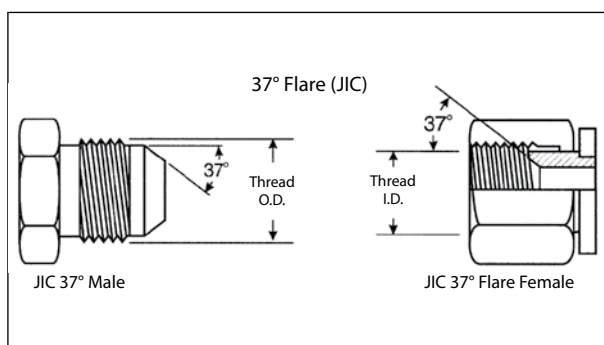

Thread Identification Table

SAE J514 37° Flare (JIC)

Tube Size	Tube Size	Thread Size	Female Thread I.D.		Male Thread O.D.	
			(mm)	(in)	(mm)	(in)
-2	1/8	5/16-24	6.9	0.27	7.8	0.31
-3	3/16	3/8-24	8.5	0.34	9.4	0.37
-4	1/4	7/16-20	9.9	0.39	11.2	0.44
-5	5/16	1/2-20	11.5	0.45	12.6	0.49
-6	3/8	9/16-18	12.9	0.51	14.1	0.56
-8	1/2	3/4-16	17.5	0.69	18.9	0.74
-10	5/8	7/8-14	20.5	0.81	22.1	0.87
-12	3/4	1.1/16-12	24.9	0.98	26.9	1.06
-14	7/8	1.3/16-12	28.1	1.11	30.3	1.18
-16	1	1.5/16-12	31.3	1.23	33.1	1.31
-20	1.1/4	1.5/8-12	39.2	1.54	41.1	1.62
-24	1.1/2	1.7/8-12	45.6	1.79	47.4	1.87
-32	2	2.1/2-12	61.4	2.42	63.3	2.49

CAUTION: In the -02, -03, -04, -05, -08 and -10 sizes, the threads of the SAE 45° flare and the SAE 37° flare are the same. However, the sealing surface angles are not the same. Carefully measure the seat angle to differentiate.

SAE J512 45°

A term usually applied to fittings having a 45° angle flare or seat. Soft copper tubing is generally used in such applications as it is easily flared to the 45° angle. These are for low pressure applications - commonly used in refrigeration, automotive and truck piping systems. The SAE 45° flare male will mate with an SAE 45° flare female only.

The SAE male has straight threads and a 45° flare seat.

The SAE female has straight threads and a 45° flare seat.

The seal is made on the 45° flare seat.

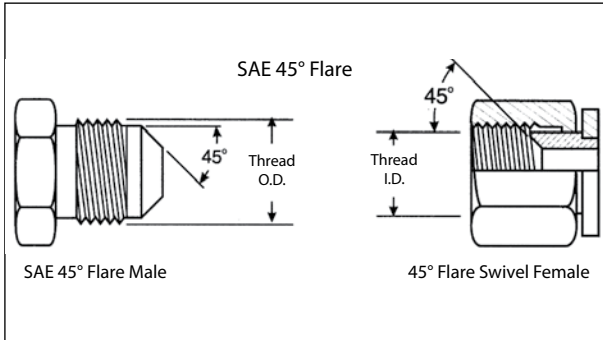

Thread Identification Table

SAE J512 45°

Tube Size	Tube Size (in)	Thread Size (in-TPI)	Female Thread I.D.		Male Thread O.D.	
			(mm)	(in)	(mm)	(in)
-2	1/8	5/16-24	6.9	0.27	7.9	0.31
-3	3/16	3/8-24	8.6	0.34	9.6	0.38
-4	1/4	7/16-20	9.9	0.39	11.2	0.44
-5	5/16	1/2-20	11.4	0.45	12.7	0.50
-6	3/8	5/8-18	14.2	0.56	15.7	0.62
-7	7/16	11/16-16	15.7	0.62	17.3	0.68
-8	1/2	3/4-16	17.0	0.68	19.0	0.75
-10	5/8	7/8-14	20.3	0.80	22.3	0.88
-12	3/4	1.1/16-14	25.1	0.99	26.9	1.06
-14	7/8	1.1/4-12	29.5	1.16	31.7	1.25
-16	1	1.3/8-12	32.5	1.28	35.0	1.38

The threads hold the connection mechanically.

CAUTION: In the -02, -03, -04, -05, -08 and -10 sizes, the threads of the SAE 45° flare and the SAE 37° flare are the same. However, the sealing surface angles are not the same. Carefully measure the seat angle to differentiate.

SAE J1453 O-Ring Face Seal (ORFS)

A seal is made when the O'ring in the male contacts the flat face on the female. Couplings are intended for hydraulic systems where elastomeric seals are acceptable to overcome leakage and leak resistance is crucial. This connection offers the very best leakage control available today.

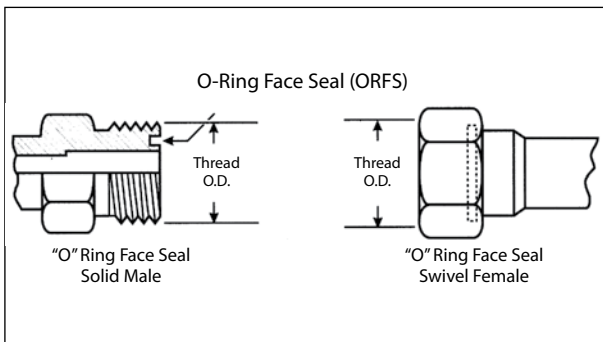

Thread Identification Table

SAE J1453 O-Ring Face Seal (ORFS)

Tube Size	Tube Size (in)	Thread Size (in-TPI)	Female Thread I.D.		Male Thread O.D.	
			(mm)	(in)	(mm)	(in)
-4	1/4	9/16-18	12.9	0.51	14.1	0.56
-6	3/8	11/16-16	15.9	0.63	17.3	0.68
-8	1/2	13/16-16	19.1	0.75	20.5	0.81
-10	5/8	1-14	23.6	0.93	25.2	0.99
-12	3/4	1.3/16-12	28.1	1.11	30.0	1.18
-16	1	1.7/16-12	34.4	1.36	36.3	1.43
-20	1.1/4	1.11/16-12	40.8	1.61	42.7	1.68
-24	1.1/2	2-12	48.7	1.92	50.6	1.99

The male connector has a straight thread and a machined flat face. The female has a straight thread and a machined flat face. The seal takes place by compressing the O-Ring onto the flat face of the female, similar to the split flange type fitting. The threads hold the connection mechanically.

SAE J512 Inverted Flare

This connection is frequently used in automotive systems. The male connector can either be a 45° flare in the tube fitting form or a 42° seat in the machined adapter form. The female has a straight thread with a 42° inverted flare. The seal takes place on the flared surface. The threads hold the connection mechanically.

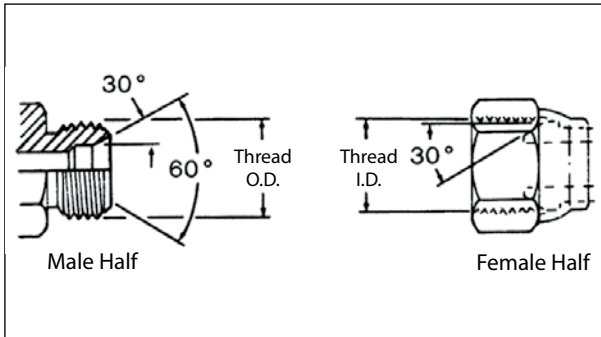

Thread Identification Table

SAE J512 Inverted Flare

Dash	Tube Size	Thread Size	Female Thread I.D.		Male Thread O.D.	
	(in)	(in-TPI)	(mm)	(in)	(mm)	(in)
-2	1/8	5/16-28	6.9	0.27	7.9	0.31
-3	3/16	3/8-24	8.6	0.34	9.6	0.38
-4	1/4	7/16-24	9.9	0.39	11.2	0.44
-5	5/16	1/2-20	11.4	0.45	12.7	0.50
-6	3/8	5/8-18	14.2	0.56	15.7	0.62
-7	7/16	11/16-18	15.7	0.62	17.3	0.68
-8	1/2	3/4-18	17.0	0.68	19.0	0.75
-10	5/8	7/8-18	20.3	0.80	22.3	0.88
-12	3/4	1.1/16-16	25.1	0.99	26.9	1.06

SAE J1467 Clip Fastener

This is a radial O-Ring seal connection commonly used for hydraulic applications in underground mines. The male contains an exterior O-Ring and backup ring, plus a groove to accept the "staple". The female has a smooth bore with two holes for the staple.

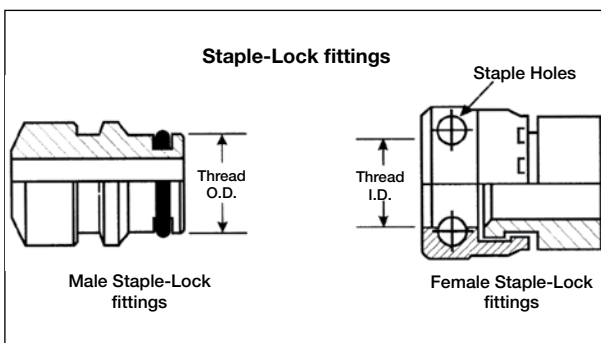

Thread Identification Table

SAE J1467 Clip Fastener

Dash Size	Inch Size	Female Staple-Lock I.D.		Male Staple-Lock O.D.	
	(in)	(mm)	(in)	(mm)	(in)
-4	1/4	14.9	19/32	15.1	19/32
-6	3/8	19.9	51/64	20.1	51/64
-8	1/2	23.9	61/64	24.1	61/64
-12	3/4	28.9	1.9/64	29.1	1.9/64
-16	1	38.9	1.35/64	39.1	1.35/64
-20	1.1/4	45.9	1.13/16	46.1	1.13/16
-24	1.1/2	54.9	1.11/64	55.2	2.11/64
-32	2	63.9	1.17/32	64.2	2.17/32

A "U" shaped retaining clip or staple is inserted through the two holes, passing through the groove in the male to lock the connection together. The seal takes place by contact between the O-Ring in the male and the smooth bore of the female.

SAE J518/ISO - DIS 6162/JIS B8363 O-Ring Flange

This connection is commonly used in fluid power system. There are two pressure ratings. Code 61 Form R, PN 35/350 bar, Type I, is referred to as the "standard" series and Code 62 Form S, PN 415 bar, Type II, is the "heavy duty" "6000 psi" series. The design concept for both series is the same, but the bolt hole spacing and flanged head diameters are larger for the higher pressure, Code 62 connection.

The female (port) is an unthreaded hole with four bolt holes in a rectangular pattern around the port.

The male consists of a flanged head, grooved for an O-Ring, and either a captive flange or split flange halves with bolt holes to match the port. The seal take place on the O-Ring, which is compressed between the flange head and the flat surface surrounding the port. The threaded bolts hold the connection together.

SAE J518, DIN 20066, ISO/DIS 6162 and JIS B 8363 are interchangeable, except for bolt sizes.

*All Code 61 flange head hose couplings meet or exceed SAE J518 Code 61 requirements for hydraulic split flange connections. The Code 61 flange head design can withstand a maximum operating pressure of 3000 to 5000 psi depending on size.

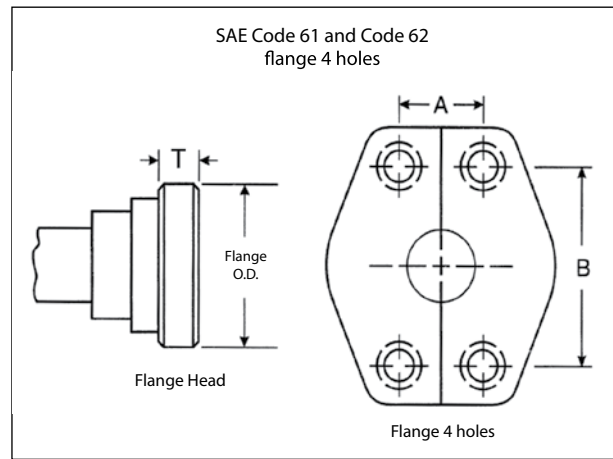

Flange Dash	SAE Cod 61 FORM R - PN 35/350 - TYPE I								SAE Cod 62 FORM S - PN 415 - TYPE II								CATERPILLAR								
	Flange Head Size		Flange Head T		A		B		Flange Head Size		Flange Head T		A		B		Flange Head Size		Flange Head T		A		B		
Size	(in)	(mm)	(in)	(mm)	(in)	(mm)	(in)	(mm)	(in)	(mm)	(in)	(mm)	(in)	(mm)	(in)	(mm)	(in)	(mm)	(in)	(mm)	(in)	(mm)	(in)	(mm)	
-8	1.19	30.2	.265	6.7	.69	17.5	1.50	38.1	1.25	31.8	.305		.71	18.2	1.59	40.5									
-10*	1.34	34.0	.265	6.7	.78	19.8	1.69	42.9																	
-12	1.50	38.1	.265	6.7	.87	22.2	1.89	47.6	1.63	41.3	.345	8.7	.94	23.8	2.00	50.8	1.63	41.3	.56	14.2	.94	23.8	2.00	50.8	
-16	1.75	44.5	.315	8.0	1.03	26.2	2.05	52.4	1.88	47.6	.375	9.5	1.10	27.8	2.25	57.2	1.88	47.6	.56	14.2	1.10	27.8	2.25	57.2	
-20	2.00	50.8	.315	8.0	1.19	30.2	2.31	58.7	2.13	54.0	.405	10.3	1.26	31.8	2.63	66.7	2.13	54.0	.56	14.2	1.26	31.8	2.63	66.7	
-24	2.38	60.3	.315	8.0	1.41	35.7	2.75	69.9	2.50	63.5	.495	12.6	1.44	36.6	3.13	79.4	2.50	63.5	.56	14.2	1.44	36.6	3.13	79.4	
-32	2.81	71.4	.375	9.5	1.69	42.9	3.06	77.8	3.13	79.4	.495	12.6	1.73	44.4	3.81	96.8	3.13	79.4	.56	14.2	1.73	44.4	3.81	96.8	
-40	3.31	84.1	.375	9.5	2.00	50.8	3.50	88.9																	

T = Thickness
 -10 is a non SAE size flange

How to measure

Four Bolt Flange - First measure the port hole diameter using the caliper. Next, measure the longest bolt hole spacing from centre-to-centre (Dimension "A") or measure the flanged head diameter. O.D.

1. The size -10, which is common outside of North America is not an SAE Standard size.
2. Caterpillar flanges, which are the same flange O.D. as SAE Code 62, have a thicker flange head.
3. Poclairn flanges, which are completely different from SAE flanges.

BRITISH CONNECTIONS

British Standard Pipe Parallel (BSPP)

Popular couplings British Standard Pipe (BSP) threads, also known as Whitworth threads.

The BSPP (parallel) male will mate with a BSPP (parallel) female or a female port.

The BSPP male has straight threads and a 30° seat.

The BSPP female has straight threads and a 30° seat.

The female port has straight threads and a spotface. The seal on the port is made with an O-Ring or soft metal washer on the male. The BSPP (parallel) connector is similar to, but not interchangeable with, the NPSM connector. The thread pitch is different in most sizes, and the thread angle is 55° instead of the 60° angle found on NPSM threads. The female swivel BSPP has a tapered nose which seals on the cone seat of the male.

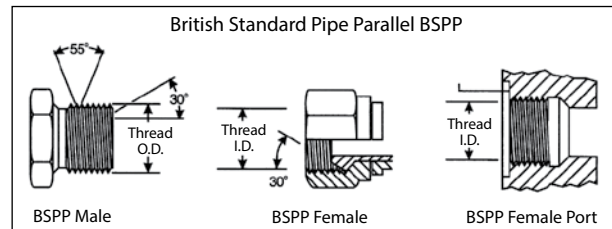

British Standard Pipe Tapered (BSPT)

The BSPT (tapered) male will mate with a BSPT (tapered) female, or a BSPP (parallel) female. The BSPT male has tapered threads. When mating with either the BSPT (tapered) female or the BSPP (parallel) female port, the seal is made on the threads accomplished by thread distortion. A thread sealant is recommended.

The BSPT connector is similar to, but not interchangeable with, the NPTF connector. The thread pitch is different in most cases, and the thread angle is 55° instead of the 60° angle found on NPTF threads.

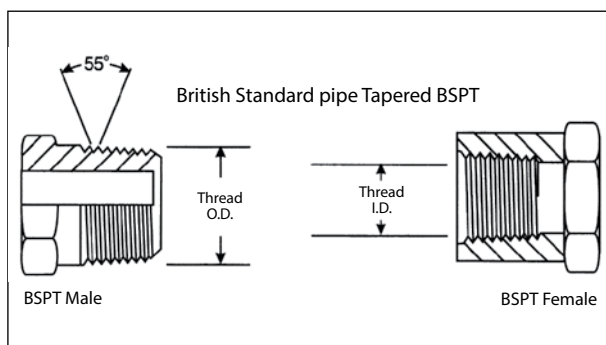

Thread Identification Table

BSPP - (British Standard Pipe Parallel)

BSPT - (British Standard Pipe Tapered)

Dash Size	Inch Size	Thread Size	Female Thread I.D.		Male Thread O.D.	
			(mm)	(in)	(mm)	(in)
-2	1/8	1/8-27	8.7	0.34	9.5	0.38
-4	1/4	1/4-18	11.1	0.44	13.5	0.56
-6	3/8	3/8-18	15.1	0.59	16.7	0.66
-8	1/2	1/2-14	18.3	0.72	20.6	0.81
-10	5/8	5/8-14	20.6	0.81	23.0	0.91
-12	3/4	3/4-14	23.8	0.94	26.2	1.03
-16	1	1-11	30.2	1.19	33.3	1.31
-20	1-1/4	1.1/4-11	38.9	1.53	41.1	1.66
-24	1-1/2	1.1/2-11	45.2	1.78	47.6	1.88
-32	2	2-11	56.4	2.22	59.5	2.34

FRENCH CONNECTIONS

French GAZ have a 24° seat and metric threads. These are similar to German DIN couplings, but the threads are different in some sizes, the French use fine threads in all sizes. French flanges are different than SAE, they have a lip that protrudes from the flange face. These are Poclairn style flanges.

Millimetrique and GAZ 24°

This connection consists of a common male and two different females. The French Metric (GAZ) male will mate with the female 24° cone or the female tube fitting. The male has a 24° seat and straight metric threads. The female has a 24° seat or a tubing sleeve and straight metric threads. The Millimetrique Series is used with whole number metric O.D. tubing and the GAZ Series is used with fractional number metric O.D. pipe size tubing.

Thread Identification Table French Metric Millimetrique

Metric Thread	Female Thread I.D.		Male Thread O.D.		Tube O.D.	
	(mm)	(in)	(mm)	(in)	(mm)	(in)
M12 X 1.0	11.0	0.43	12.0	0.47	6	0.24
M14 X 1.5	12.5	0.49	14.0	0.55	8	0.31
M16 X 1.5	14.5	0.57	16.0	0.63	10	0.39
M18 X 1.5	16.5	0.65	18.0	0.71	12	0.47
M20 X 1.5	18.5	0.73	20.0	0.79	14	0.55
M22 X 1.5	20.5	0.81	22.0	0.87	15	0.59
M24 X 1.5	22.5	0.89	24.0	0.94	16	0.63
M27 X 1.5	25.5	1.00	27.0	1.06	18	0.71
M30 X 1.5	28.5	1.12	30.0	1.18	22	0.87
M33 X 1.5	31.5	1.24	33.0	1.30	25	0.98
M36 X 1.5	34.5	1.36	36.0	1.42	28	1.10
M39 X 1.5	37.5	1.48	39.0	1.54	30	1.18
M42 X 1.5	40.5	1.59	42.0	1.65	32	1.26
M45 X 1.5	43.5	1.71	45.0	1.77	35	1.38
M48 X 1.5	46.5	1.83	48.0	1.89	38	1.50
M52 X 1.5	50.5	1.99	52.0	2.05	40	1.57
M54 X 2.0	51.9	2.04	54.0	2.13	45	1.77

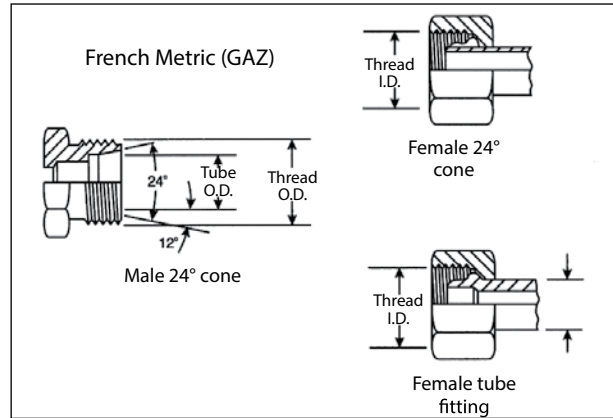

Thread Identification Table French Metric GAZ 24° Cone

Dash Size	Metric Thread (dia x pitch)	Female Thread I.D.		Male Thread O.D.		Tube O.D.	
		(mm)	(in)	(mm)	(in)	(mm)	(in)
-6	M20 X 1.5	18.5	0.73	20.0	0.78	13.25	0.52
-8	M24 X 1.5	22.5	0.89	24.0	0.94	16.75	0.66
-10	M30 X 1.5	28.5	1.12	30.0	1.18	21.25	0.83
-12	M36 X 1.5	34.5	1.36	36.0	1.41	26.75	1.05
-16	M45 X 1.5	43.5	1.71	45.0	1.77	33.50	1.32
-20	M52 X 1.5	50.5	1.99	52.0	2.04	42.25	1.66

GAZ Poclairn 24° Flange

The Poclairn (French GAZ) 24° high pressure flange is usually found on Poclairn equipment. The male flange will mate with a female flange or a port. The seal is made on the 24° seat.

Nominal Size (in)	A		B		E	
	(mm)	(in)	(mm)	(in)	(mm)	(in)
1/2	39.9	1.57	18.3	.72	14	.55
5/8	39.9	1.57	18.3	.72	14	.55
3/4	50.8	2	23.9	.94	18	.71

GERMAN DIN CONNECTIONS

A coupling referred to as metric, usually means a DIN coupling. Flanges are standard Code 61 or Code 62.

DIN 2353 24° Cone

The DIN 24° cone male will mate with any of the three females shown below.

The male has a 24° seat, straight metric threads, and a recessed counterbore which matches the tube O.D. used with it. The mating female may be a 24° cone with O'ring, (DKO type) a metric tube fitting or a universal 24° or 60° cone.

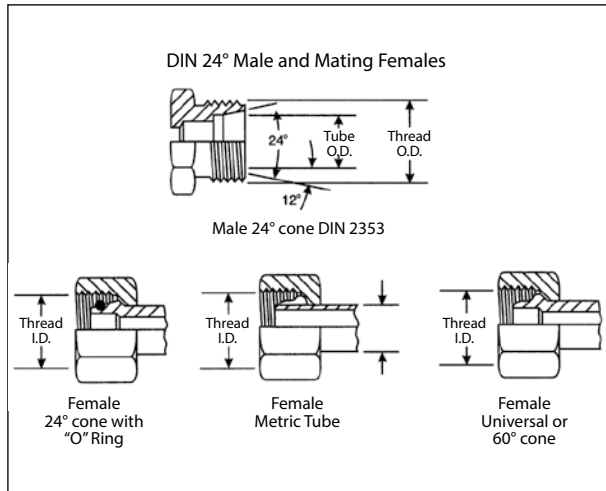

Thread Identification Table

DIN 24° Cone

Metric (dia x pitch)	Female Thread I.D.		Male Thread		Tube O.D.			
	I.D.		O.D.		Light Series		Heavy Series	
	(mm)	(in)	(mm)	(in)	(mm)	(in)	(mm)	(in)
M12 X 1.5	10.5	0.41	12	0.47	6	0.24		
M14 X 1.5	12.5	0.49	14	0.55	8	0.31	6	0.24
M16 X 1.5	14.5	0.57	16	0.63	10	0.39	8	0.31
M18 X 1.5	16.5	0.65	18	0.71	12	0.47	10	0.39
M20 X 1.5	18.5	0.73	20	0.79			12	0.47
M22 X 1.5	20.5	0.81	22	0.87	15	0.59	14	0.55
M24 X 1.5	22.5	0.89	24	0.94			16	0.63
M26 X 1.5	24.5	0.96	26	1.02	18	0.71		
M30 X 2.0	27.9	1.10	30	1.18	22	0.87	20	0.79
M36 X 2.0	33.9	1.33	36	1.42	28	1.10	25	0.98
M42 X 2.0	39.9	1.57	42	1.65			30	1.18
M45 X 2.0	42.9	1.69	45	1.77	35	1.38		
M52 X 2.0	49.9	1.96	52	2.05	42	1.65	38	1.50

There is a light and heavy series DIN coupling.

Proper identification is made by measuring both the thread size and the tube O.D. (The heavy series has a smaller tube O.D. than the light, but has a thicker wall section).

DIN 3863 60° Cone

This connection is frequently used in hydraulic systems.

The DIN 60° cone male will mate with the female universal 24° or 60° cone only.

The male has a 60° seat and straight metric threads. The female has a 24° and 60° universal seat and straight metric threads. The seal takes place by contact between the cone of the male and the nose of the flareless swivel.

The threads hold the connection mechanically.

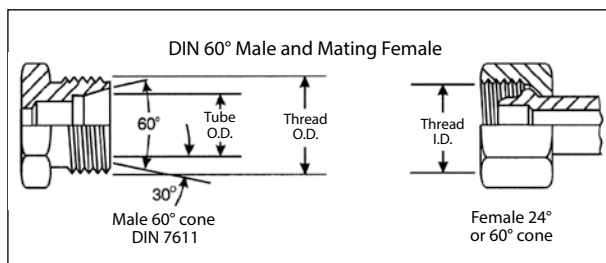

Thread Identification Table

DIN 60°

Metric Thread (dia x pitch)	Female Thread I.D.		Male Thread O.D.		Tube O.D.	
	(mm)	(in)	(mm)	(in)	(mm)	(in)
M12 X 1.5	10.5	0.41	12	0.47	6	0.24
M14 X 1.5	12.5	0.49	14	0.55	8	0.31
M16 X 1.5	14.5	0.57	16	0.63	10	0.39
M18 X 1.5	16.5	0.65	18	0.71	12	0.47
M22 X 1.5	20.5	0.81	22	0.87	15	0.59
M26 X 1.5	24.5	0.96	26	1.02	18	0.71
M30 X 1.5	28.5	1.12	30	1.18	22	0.87
M38 X 1.5	36.5	1.44	38	1.50	28	1.10
M45 X 1.5	43.5	1.71	45	1.77	35	1.38
M52 X 1.5	50.5	1.99	52	2.05	42	1.65

Metric Standpipe

A metric standpipe is comprised of three components attached to a male fitting. The components are a Standpipe, Bite Sleeve and Metric Nut. The nut is placed over the Standpipe, followed by the Bite Sleeve (see illustration below). For DIN light assemblies, a DIN light metric nut is used. For DIN heavy assemblies, a DIN heavy metric nut is used. Bite Sleeve and Standpipe are selected on the basis of tube O.D.

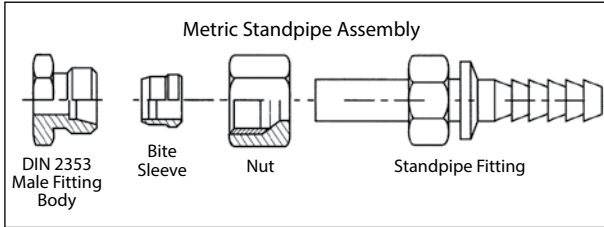

Tube O.D. (mm)	Metric Nut Thread	
	Light	Heavy
6	M12 x 1.5	
8	M14 x 1.5	M16 x 1.5
10	M16 x 1.5	M18 x 1.5
12	M18 x 1.5	M20 x 1.5
15	M22 x 1.5	
16		M24 x 1.5
18	M26 x 1.5	
20		M30 x 2.0
22	M30 x 1.5	
25		M36 x 2.0
28	M36 x 2.0	
30		M42 x 2.0
35	M45 x 2.0	
38		M52 x 2.0
42	M52 x 2.0	

JAPANESE CONNECTIONS

Japanese equipment uses JIS (Japanese Industrial Standard) couplings with a 30° seat and British Standard Pipe Parallel threads. All flanges are Code 61 or Code 62 (except -10).

JIS 30° Flare Parallel Pipe Threads - JIS B 0202

These Japanese 30° flare male coupling will mate with a Japanese 30° flare female only. The male and female have straight threads and a 30° seat. The seal is made on the 30° seat. The threads on the Japanese 30° flare connector conform to JIS B 0202, the same as the BSPP threads. Both the British and Japanese connectors have a 30° seat, but they are not interchangeable, because the British seat is inverted.

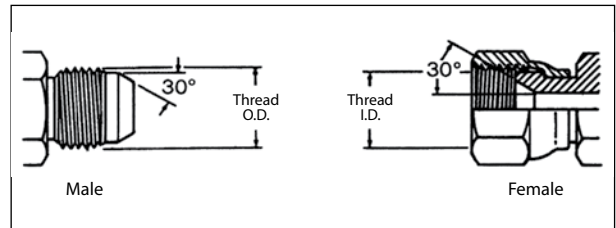

JIS 30° Inverted Seat, Parallel Pipe Threads - JIS B 0202

The JIS parallel is similar to the BSPP connection. The JIS parallel thread and the BSPP connection are interchangeable.

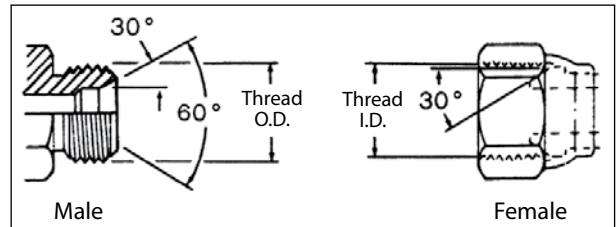

JIS Tapered Pipe Thread (PT) - JIS B 0203

The JIS tapered pipe thread connection is similar to the BSPT connection and fully interchangeable. The Japanese connection does not have a 30° Flare, and will not mate with the BSPP female. The thread conforms to JIS B 0203, same as BSPT threads. The seal on the JIS tapered pipe thread connection is made on the threads.

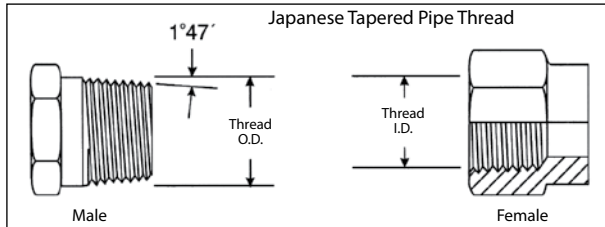

Thread Identification Table

Dash Size	Inch Size	Thread Size (in-TPI)	Female Thread I.D.		Male Thread O.D.	
			(mm)	(in)	(mm)	(in)
-2	1/8	1/8-27	8.7	0.34	9.5	0.38
-4	1/4	1/4-18	11.1	0.44	13.5	0.56
-6	3/8	3/8-18	15.1	0.59	16.7	0.66
-8	1/2	1/2-14	18.3	0.72	20.6	0.81
-10	5/8	5/8-14	20.6	0.81	23.0	0.91
-12	3/4	3/4-14	23.8	0.94	26.2	1.03
-16	1	1-11	30.2	1.19	33.3	1.31
-20	1-1/4	1.1/4-11	38.9	1.53	41.1	1.66
-24	1-1/2	1.1/2-11	45.2	1.78	47.6	1.88
-32	2	2-11	56.4	2.22	59.5	2.34

Komatsu Style 30° Flare Parallel Threads

The Komatsu style 30° Flare Parallel thread coupling is identical to the Japanese 30° Flare parallel except for the threads. The Komatsu uses Metric fine threads which conform to JIS B 0207. The Komatsu connector seals on the 30° Flare.

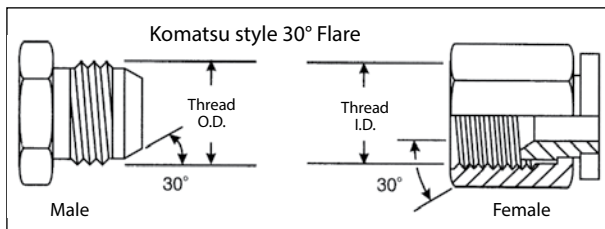

Dash Size	Inch Size	Metric Thread Size	Male Thread O.D.	B Thread I.D.
			(mm)	(mm)
-6	3/8	M18x1.5	18	16.4
-8	1/2	M22x1.5	22	20.4
-10	5/8	M24x1.5	24	22.4
-12	3/4	M30x1.5	30	28.4
-16	1	M33x1.5	33	31.4
-20	1-1/4	M36x1.5	36	34.4
-24	1-1/2	M42x1.5	42	40.4

Komatsu Flange Fitting

The Komatsu Flange fitting is nearly identical to and fully interchangeable with the SAE Code 61 flange fitting. In all sizes the O-ring dimensions are different. When replacing a Komatsu flange with an SAE style flange, an SAE style O-ring must be used.

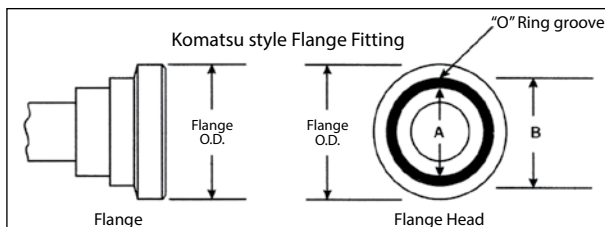

Flange Dash Size	Flange Size (In)	A	B
-8	1.19	.73	.98
-10*	1.34	.73	1.10
-12	1.50	.85	1.22
-16	1.75	1.12	1.50
-20	2.00	1.36	1.73
-24	2.38	1.75	2.12
-32	2.81	2.22	2.56

*is a non SAE size flange

RACOMMENDED FITTING AND ADAPTER INSTALLATION TORQUE

SAE J514 37° CONE (JIC)

Dash	Thread	Lb.ft		N.m	
		Min	Max	Min	Max
-4	7/16-20	11	12	15	16
-5	1/2-20	14	15	19	21
-6	9/16-18	18	20	24	28
-8	3/4-16	36	39	49	53
-10	7/8-14	57	63	77	85
-12	1 1/16-12	79	88	107	119
-14	1 3/16-12	94	103	127	140
-16	1 5/16-12	108	113	147	154
-20	1 5/8-12	127	133	172	181
-24	1 7/8-12	158	167	215	226
-32	2 1/2-12	245	258	332	350

BSPP without O-Ring

Dash	Thread	Lb.ft	N.m
-2	1/8-28	7	10
-4	1/4-19	15	20
-6	3/8-19	26	35
-8	1/2-14	44	60
-10	5/8-14	52	70
-12	3/4-14	85	115
-16	1-11	103	140
-20	1 1/4-11	155	210
-24	1 1/2-11	214	290
-32	2-11	295	400

SAE J1453 O-Ring Face Seal (ORFS)

Dash	Thread	Lb.ft		N.m	
		Min	Max	Min	Max
-4	9/16-18	18	21	25	28
-6	11/16-16	30	32	40	44
-8	13/16-16	41	44	55	60
-10	1-14	46	50	60	68
-12	1 3/16-12	65	70	90	95
-16	1 7/16-12	92	100	125	135
-20	1 11/16-12	125	140	170	190
-24	2-12	150	165	200	225

BSPP with O-Ring

Dash	Thread	Lb.ft	N.m
-2	1/8-28	N/A	N/A
-4	1/4-19	15	20
-6	3/8-19	26	35
-8	1/2-14	37	50
-10	5/8-14	44	60
-12	3/4-14	63	85
-16	1-11	85	115
-20	1 1/4-11	140	190
-24	1 1/2-11	177	240
-32	2-11	221	300

SAE Flange J518 Code 61

Dash	Thread	Lb.ft		N.m	
		Min	Max	Min	Max
-8	1/2	15	19	20	25
-12	3/4	21	29	28	40
-16	1	27	35	37	48
-20	1 1/4	35	46	48	62
-24	1 1/2	46	58	62	79
-32	2	54	66	73	90
-40	2 1/2	79	91	107	124
-48	3	137	149	186	203

JIS (B8363)

Dash	Thread	Lb.ft	N.m
-4	1/4-19	19	25
-6	3/8-19	25	34
-8	1/2-14	49	64
-10	5/8-14	100	132
-12	3/4-14	100	132
-16	1-11	149	196
-20	1 1/4-11	171	225
-24	1 1/2-11	194	255
-32	2-11	240	316

SAE J518 Code 62

Dash	Thread	Lb.ft		N.m	
		Min	Max	Min	Max
-8	1/2	15	19	20	25
-12	3/4	25	33	34	45
-16	1	42	50	56	68
-20	1 1/4	63	75	85	102
-24	1 1/2	117	133	158	181
-32**	2	200	217	271	294

Metric

Thread	Lb.ft		N.m	
	Min	Max	Min	Max
M12x1,5	8	11	15	20
M14x1,5	13	18	25	30
M16x1,5	19	26	35	40
M18x1,5	22	30	40	45
M20x1,5	24	33	45	50
M22x1,5	32	44	60	70
M24x1,5	41	55	75	85
M26x1,5	46	63	85	95
M30x2	57	77	105	120
M36x2	74	100	135	150
M42x2	111	151	205	230
M45x2	136	184	250	280
M52x2	147	199	270	300

JIC FFFT TORQUE METHOD

The FFFT (Flats From Finger Tight) method allows to assemble fittings and adapters at the correct torque value without a dynamometric wrench. The rotation applied according the value shown in tab.1 ensures a good sealing, avoid unscrewing and over torque that can cause nut or cone crack.

Assembling instruction:

- hand tighten the joint
- make a longitudinal mark on one of the flats of hex and continue it on the body hex as shown in Fig.1
- tighten the joint further by the number of flat as shown in Tab.1

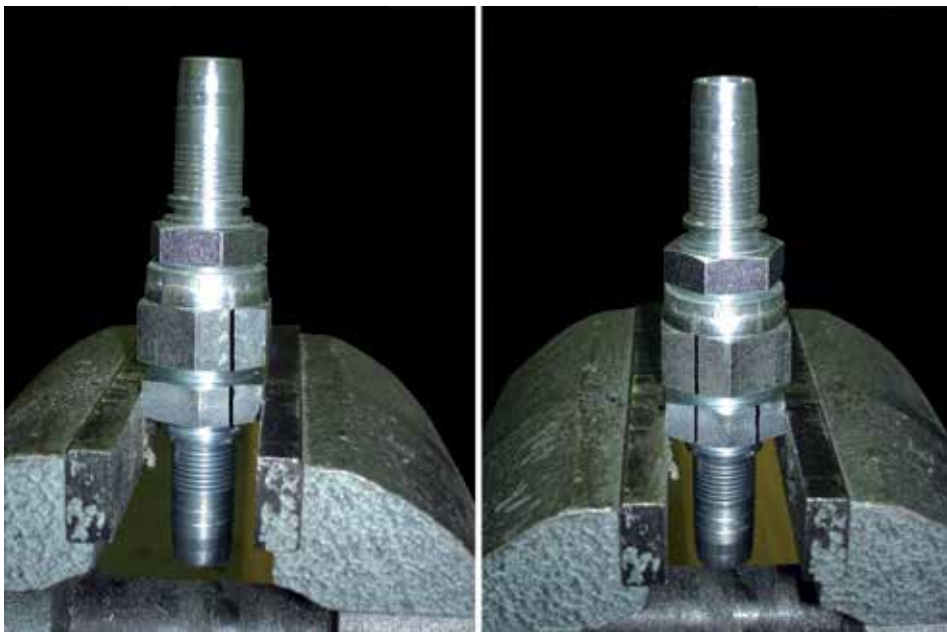

Fig. 1

Assembling value - carbon steel material - SAE J514 JIC 37° flare						
Dash size	Thread	Lb*ft		N*m		FFFT
		min	max	min	max	
-4	7/16-20	11	12	15	16	2
-5	1/2-20	14	15	19	21	2
-6	9/16-18	18	20	24	28	2
-8	3/4-16	36	39	49	53	1.5
-10	7/8-14	57	63	77	85	1.5
-12	1 1/16-12	79	88	107	119	1
-14	1 3/16-12	94	103	127	140	1
-16	1 5/16-12	108	113	147	154	1
-20	1 5/8-12	127	133	172	181	1
-24	1 7/8-12	158	167	215	226	1
-32	2 1/2-12	245	258	332	350	1

Tab. 1

HOW TO DETERMINE THE THREAD TYPE USING CALLIPERS

By measuring with a caliper the outside diameter of the thread of a male or the inside diameter of the thread of a female you will get a measure in mm. By finding this value in mm on the below table, you'll be able to find the relevant thread type.

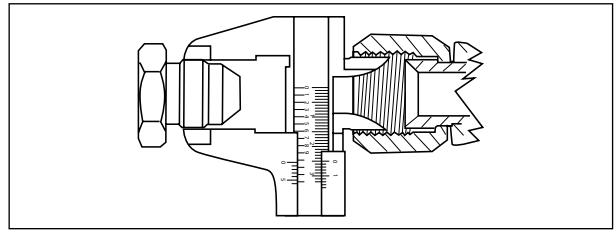

Male OD	mm	Female ID
	8,7	G1/8" BSP
1/8" – 27 NPTF	9,5	
G1/8" BSP	9,6	
M 10 x 1	9,8	
	9,9	7/16" – 20 JIC
	10,5	M 12 x 1,5
7/16" – 20 JIC	11,0	
	11,4	1/2" – 20 SAE
	11,6	G1/4" BSP
M 12 x 1,5	11,9	
1/4" – 18 NPTF	12,5	
	12,5	M 14 x 1,5
1/2" – 20 SAE	12,6	
	12,9	9/16" – 18 JIC
G1/4" BSP	13,0	
M 14 x 1,5	13,9	
9/16" – 18 JIC	14,2	
	14,5	M16 x 1,5
	15,1	G3/8" BSP
M 16 x 1,5	15,8	
3/8" – 18 NPTF	15,9	
	16,5	M18 x 1,5
G3/8" BSP	16,6	
	17,5	3/4" – 16 JIC
M 18 x 1,5	17,9	
	18,4	20 x 1,5 DKF
3/4" – 16 JIC	18,8	
	18,8	G1/2" BSP
1/2" – 14 NPT	19,8	
20 x 1,5 CEF	19,9	
	20,4	7/8" – 14 SAE
	20,5	M 22 x 1,5
G1/2" BSP	20,8	
	20,9	G5/8" BSP
M 22 x 1,5	21,9	
7/8" – 14 SAE	22,1	
	22,5	24 x 1,5 DKF
G5/8" BSP	22,8	
24 x 1,5 CEF	23,9	
	24,5	G3/4" BSP
	24,8	1 1/16" – 12 JIC
3/4" – 14 NPTF	25,1	
	25,5	M26 x 1,5
M 26 x 1,5	25,9	
G3/4" BSP	26,3	
1 1/16" – 12 JIC	26,8	

Male OD	mm	Female ID
	27,9	1 3/16" – 12 JIC
	28,0	M 30 x 2
	28,5	30 x 1,5 DKF
M 30 x2	29,8	
30 x 1,5 CEF	29,9	
1 3/16" – 12 JIC	30,1	
	30,7	G1" BSP
	31,2	1 5/16" – 12 JIC
1" – 11 1/2 NPTF	31,4	
	31,5	M 33 x 1,5
G1" BSP	33,1	
1 5/16" – 12 JIC	33,2	
	34,0	M 36 x 2
	34,5	36 x 1,5 DKF
M 36 x 2	35,8	
36 x 1,5 CEF	35,9	
	36,5	M 36 x 1,5
M 38 x 1,5	37,9	
	38,8	1 5/8" – 12 JIC
	39,4	G1 1/4" BSP
	39,8	M 42 x 1,5
1 1/4"–11 1/2 NPTF	40,2	
	40,5	M 42 x 1,5
1 5/8" – 12 JIC	41,1	
1 1/4" – 11 BSP	41,7	
M 42 x2	41,8	
	42,4	M 45 x 2
	43,3	45 x 1,5 DKF
M 45 x2	44,8	
45 x 1,5 CEF	44,9	
	45,1	1 7/8" – 12 JIC
	45,2	G1 1/2" BSP
1 1/2"–11 1/2 NPTF	46,3	
1 7/8" – 12 JIC	47,5	
G1 1/2" BSP	47,7	
	49,6	M 52 x 2
	50,3	52 x 1,5 DKF
M 52 x2	51,8	
52 x 1,5 CEF	51,9	
	57,4	G2" BSP
2" – 11 1/2 NPTF	58,3	
G2" BSP	59,4	
	61,1	2 1/2" – 12 JIC
	62,5	M 65 x 2
2 1/2" – 12 JIC	63,3	

PRESSURE CONVERSION TABLES

Metric to psi (1 KPa = .145 psi)

Kilo Pascal (KPa)	Mega Pascal (KPa)	Bar (Bar)	Pounds per Square Inch (psi)
100	0,1	1	14,5
200	0,2	2	29,0
300	0,3	3	43,5
400	0,4	4	58,0
500	0,5	5	72,5
600	0,6	6	87,0
700	0,7	7	101,5
800	0,8	8	116,0
900	0,9	9	130,5
1000	1	10	145,0
2000	2	20	290,1
3000	3	30	435,1
4000	4	40	580,2
5000	5	50	725,5
6000	6	60	870,2
7000	7	70	1015
8000	8	80	1160
9000	9	90	1305
10000	10	100	1450
20000	20	200	2901
30000	30	300	4351
40000	40	400	5802
50000	50	500	7252
60000	60	600	8702
70000	70	700	10153
80000	80	800	11603
90000	90	900	13053
100000	100	1000	14504
200000	200	2000	29008
300000	300	3000	43511

psi to metric (1 psi = 6,89 KPa)

Pounds per Square Inch (psi)	Kilo Pascal (KPa)	Mega Pascal (MPa)	Bar (Bar)
10	68,9	0,07	0,7
20	137,9	0,14	1,4
30	206,8	0,21	2,1
40	275,8	0,28	2,8
50	344,7	0,34	3,4
60	413,7	0,41	4,1
70	482,6	0,48	4,8
80	551,6	0,55	5,5
90	620,5	0,62	6,2
100	689	0,70	6,9
200	1379	1,4	13,8
300	2068	2,1	20,7
400	2758	2,8	27,6
500	3447	3,4	34,5
600	4137	4,1	41,4
700	4826	4,8	48,3
800	5516	5,5	55,2
900	6205	6,2	62,1
1000	6895	6,9	68,9
2000	13790	13,8	147,9
3000	20684	20,7	206,8
4000	27579	27,6	275,8
5000	34474	34,5	344,7
6000	41369	41,4	413,7
7000	48263	48,3	482,6
8000	55158	55,2	551,6
9000	62053	62,1	620,5
10000	68948	68,9	689
20000	137895	147,9	1379
30000	206843	206,8	2068
40000	275790	275,8	2758

CONVERSION TABLES FROM IMPERIAL SYSTEM TO METRIC SYSTEM

Inches	mm	Inches	mm	Inches	mm	Inches	mm				
1/64	.0156	.397	17/64	.2656	6.747	33/64	.5156	13.097	49/64	.7656	19.447
1/32	.0312	.794	9/32	.2812	7.144	17/32	.5312	13.494	25/32	.7812	19.844
3/64	.0468	1.191	19/64	.2968	7.541	35/64	.5468	13.891	51/64	.7968	20.241
1/16	.0625	1.588	15/16	.3125	7.938	9/16	.5625	14.288	13/16	.8125	20.638
5/64	.0781	2.381	21/64	.3281	8.334	37/64	.5781	14.684	53/64	.8281	21.034
3/32	.0937	2.381	11/32	.3437	8.731	19/32	.5937	15.081	27/32	.8437	21.431
7/64	.1093	2.778	23/64	.3593	9.128	39/64	.6093	15.478	55/64	.8593	21.828
1/8	.1250	3.175	3/8	.3750	9.525	5/8	.6250	15.875	7/8	.8750	22.225
9/64	.1406	3.572	25/64	.3906	9.922	41/64	.6406	16.272	57/64	.8906	22.622
5/32	.1562	3.969	13/32	.4062	10.319	21/32	.6562	16.669	29/32	.9062	23.019
11/64	.1718	4.366	27/64	.4218	10.716	43/64	.6718	17.066	59/64	.9218	23.416
3/16	.1875	4.763	7/16	.4375	11.113	11/16	.6875	17.463	15/16	.9375	23.813
13/64	.2031	5.159	29/64	.4531	11.509	45/64	.7031	17.859	61/64	.9531	24.209
7/32	.2187	5.556	15/32	.4687	11.906	23/32	.7187	18.256	31/32	.9687	24.606
15/64	.2343	5.963	31/64	.4843	12.303	47/64	.7343	18.653	63/64	.9843	25.003
1/4	.2500	6.350	1/2	.5000	12.700	3/4	.7500	19.050	1	1000	25.400

// ADAPTERS GUIDELINES

ADAPTER SELECTION

Selection of an appropriate ALFAGOMMA adapter for a given application depends on the fluid system operating parameters listed below and the tube material and wall thickness they require:

1. Type of fluid
2. Operating temperature range
3. Type of line - pressure, return or suction
4. Maximum flow rate through the line
5. Maximum operating / service pressure
6. Severity of service
7. Environment

Then, based on the tube selected and appropriate fluid system operating parameters, determine adapter type(s) and material(s) using the features comparison table below.

FEATURES COMPARISON OF TUBE FITTINGS				
Feature		ORFS	JIC 37°	BSP
Performance	Pressure capability*	Very High	Medium to High	Medium to High
	Seal Reliability	Excellent	Good	Very Good
		Elastomeric Seal	Metal to Metal Seal	Elastomeric Seal
		High tolerance to minor surface imperfections and damage. High tolerance to assembly variations.	Low tolerance to minor surface imperfections and damage. Low tolerance to assembly variations.	Low tolerance to minor surface imperfections and damage. Low tolerance to assembly variations.
Vibration Resistance in Rigid Systems	Excellent	Good	Very Good	
Tube Compatibility	Wall Thickness	All	Medium	Medium
	Critical Features	OD tolerance and hardness for flat tube, OD tolerance only for brazed tube	ID finish, wall thickness uniformity (concentricity) and hardness	OD tolerance and hardness
Assembly	Tube Preparation	Easy and quick (slower for sleeve brazing)	Easy and quick	Easy and quick (slower for welded nipple)
	Inspection	Easy and quick	Easy and quick	Critical, need experience
	Ease of Installation	Excellent, Minimum skill and training are necessary because of high tolerances to assembly variations	Good, Low tolerance to assembly variations. Requires skilled and trained personnel	
	Ease of Maintenance	Excellent, no tube entry	Very Good, Small tube entry	Good, Large tube entry
Temperature Capability Adapters without O-Ring	Steel	To be used only with O-ring	-65° F to 500° F	-65° F to 500° F
	Stainless Steel		-425° F to 1200° F	==
	Brass		-40° F to 400° F	==
Temperature Capability Adapters with O-Ring**	All Style of Adapter	-30 F to 250° F	-30 F to 250° F	-30 F to 250° F
* For details see Working Pressure Charts in the individual adapters section				
** For details concerning O-ring see section "O-ring selection" and "Fluid Resistance Table"				

JIC 37° ADAPTER (ISO 8434-2, SAE J514)

Main Features

SAE J514 and ISO 8434-2, and commonly called 37° JIC adapters.

37° JIC adapter performs extremely well in all high pressure applications.

The seal is made by connecting a 37° flared tube surface to a 37° flare male and tightening by means of a nut and a sleeve. The flared tube avoids welded connection, so high performances are guaranteed even in case of severe vibrations, mechanic/hydraulic shocks and multiple assembly/disassembly operations.

When tightened, sleeve provides tube and adapter self alignment and helps to reduce the vibrations on the tube during application.

An appropriate choice of sleeve gives the possibility of assembling adapters with both metric and inch-tubes

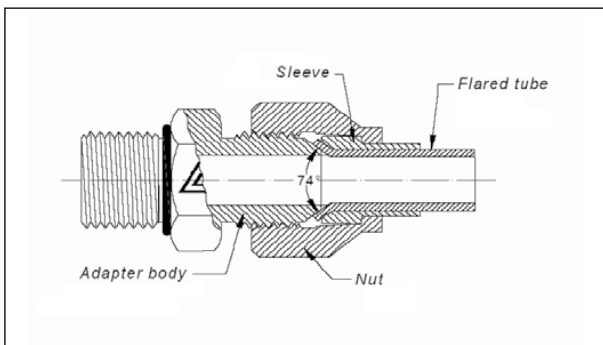

Flaring Operations

Perfect sealing is guaranteed with tubes having physical and mechanical characteristics obtained by cold-drawing and a ductility expressed as 21% of minimum elongation.

- Cut end of tube must be perpendicular to its axis . Note: cutting operation reduces the whole length of tube (almost $0,5 \pm 1$ mm for each end).
- Dimensions of the end of the tube shall allow the correct placing on the flaring machine.
- Flared surface must be inspected to avoid excessive roughness and defects such as cracks or exfoliation.
- Length of flared zone shall be enough to allow a sufficient sealing surface and avoid the blowing off of the tube, but not excessive to prevent the contact with thread of the nut.

A well followed flaring procedure assures no leakage even after frequent assembling and disassembling operations.

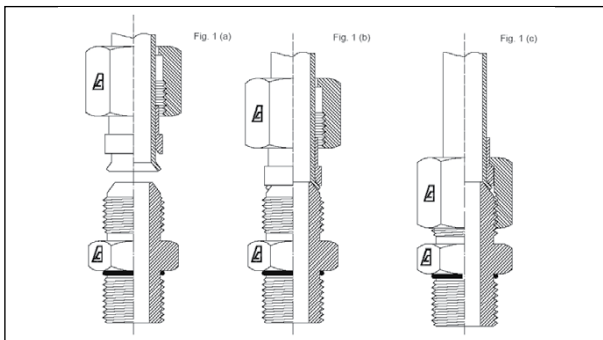

ORFS ADAPTER (ISO 8434-3, SAE J1453)

Main Features

Adapters are designed and manufactured according to standard SAE J1453 and commonly called ORFS adapters.

O-Ring Face Seal adapters performs extremely well in all high pressure applications where elastomeric seals are needed to overcome leakage and leak resistance is crucial.

A seal is made when the O-Ring in the male contacts the 180° flat face of the tube. The male connector has a straight thread and a machined flat face. The seal takes place by compressing the O-Ring onto the flat face of the female.

ORFS system is composed by:.

- Nut.
- Sleeve for flat tube and a shouldered sleeve for brazing. An appropriate choice of sleeve gives the possibility of assembling adapters with both metric and inch-tubes.
- Various kind and size of adapter body.
- O-Ring material is NBR, Shore "A": 90, suitable for a temperature range of: $-30^{\circ}\text{C}/+130^{\circ}\text{C}$ ($-22^{\circ}\text{F}/+266^{\circ}\text{F}$).

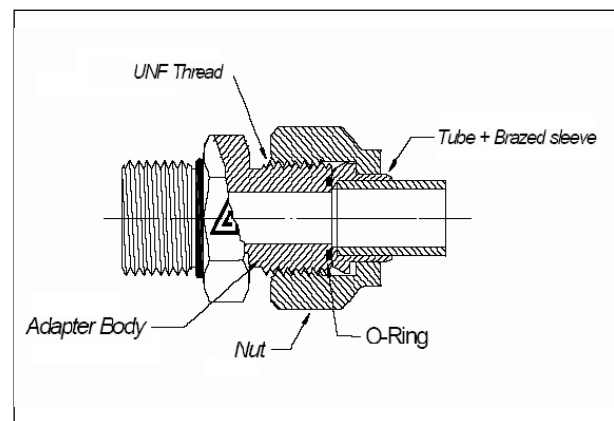

Flaring Tube Operations

Perfect sealing is guaranteed with tubes having physical and mechanical characteristics obtained by cold-drawing and a ductility expressed as 21% of minimum elongation.

- Cut end of tube must be perpendicular to its axis.
- Cutting operation reduces the whole length of tube.
- Dimensions of the end of the tube shall allow the correct placing on the flaring machine.
- Flared surface must be inspected to avoid excessive roughness and defects such as cracks or exfoliation.
- Brazing sleeve guarantees the same performances as the flared tube, and shall be used in the following cases:
- Tube is not in accordance with the above mechanical characteristics.
- The straight part of the tube is not of a sufficient length (see quote L2 and values listed in table of figure O-3).
- Tube thickness is lower than values listed in table (O-1).
- For cutting length consider shoulder of the sleeve (quote L1 of table O-1).

A well followed flaring procedure assures no leakage even after frequent assembling and disassembling operations.

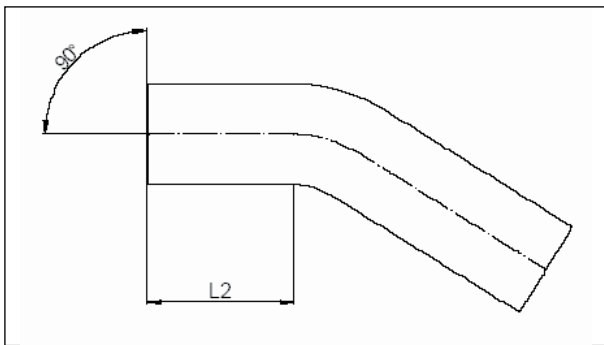

Hose mm	L2 Min mm
Ø 6 - Ø 12	73
Ø 14 - Ø 18	100
Ø 20 - Ø 22	120
Ø 25 - Ø 42	130

Only a few simple operations are required for assembling ORFS tube/adapter.

Sleeve and Tube Flared:

- 1a) Place nut and sleeve on the tube with the appropriate orientation.
- 2a) Flare the tube (see procedure)
- 3a) Place the tube near seal surface of the adapter and screw by hand.
- 4a) Lock the adapter and tighten with a torque wrench

Brazed sleeve

- 1b) Cut the tube considering quote L1 of the sleeve (See Figure O-5);
- 2b) Clean and degrease accurately the end of the tube and the sleeve;
- 3b) Put the brazing ring into the sleeve
- 4b) Apply flux at the end of the tube and in the sleeve, then assemble the sleeve on the tube;
- 5b) Start brazing and be aware of not overheating flux material;
- 6b) Clean the connecting part and verify the good quality of weld around the external diameter of the hose;
- 7b) Complete the assembly procedure as described in points 3a) and 4a). See the correct installation torque in the attached table (O-2).

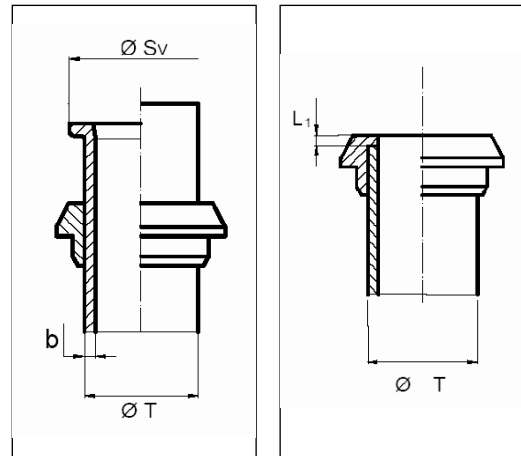

Hose		SV	
mm	In	mm	In
6	1/4	12,0	12,7
8	5/16	14,7	15,7
10	3/8	14,7	15,7
12	1/2	17,9	18,9
15		22,1	23,4
16	5/8	22,1	23,4
18		26,3	27,8
20	3/4	26,3	27,8
22		32,4	34,2
25	1	32,4	34,2
28		39,0	40,5
30		39,0	40,5
32	1.1/4	39,0	40,5
35		46,0	48,5
38	1.1/2	46,0	48,5

BSP ADAPTER (ISO 8434-6, BS 5200)

Main Features

Adapters are designed and manufactured according to standard BS 5200, ISO 8434-6 and ISO 228-1 and they are commonly called BSP adapters (British Standard Pipe). BSP adapter is widely employed, it performs extremely well in all high pressure applications with oil and gas. The seal is made by connecting a 60° coned seat to the 60° male surface and tightening the nut assembly. The O-Ring placed in the tube groove improves the sealing. There are not welded part in the locking area and performances are good even after multiple assembly and disassembly operations, severe vibrations and mechanic/hydraulic shocks.

Assembling Procedure

Only a few simple operations are required for assembling BSP tube/adaptor:

- 1) Carefully align tube and adapter. Otherwise sealing is not guaranteed.
- 2) Lubricate accurately sealing surfaces with mineral oil or suitable lubricant.
- 3) Place the tube near seal surface of the adapter and tight by hand.
- 4) Lock the adapter and tighten with a torque wrench.

See the correct installation torque in the attached table B-1

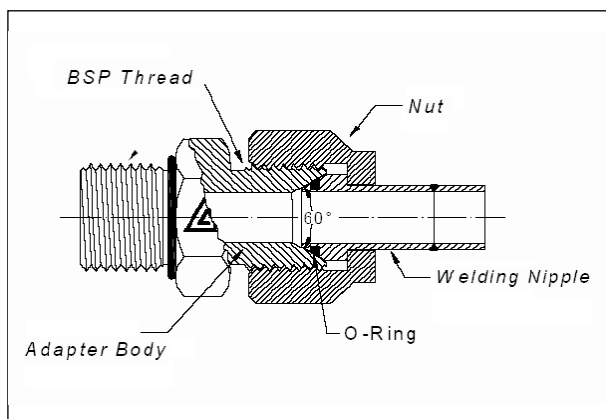

Assembly Instruction For Adjustable Adapter Thread: SAE, UNF, BSPP, Metric

Lubricate the O-Ring with mineral oil. Back off locknut as for as possible.

Make sure that washer is pushed-up as much as possible. Screw by hand the adapter into the port until the O-Ring enter the port.

To align adaptor orientation to tube end or hose assembly, unscrew the adaptor by the required amount, but not more than one full turn.

Hold the adapter in desired position by mean of a wrench and tighten locknut to the suggested torque value by means of a dynamometric wrench.

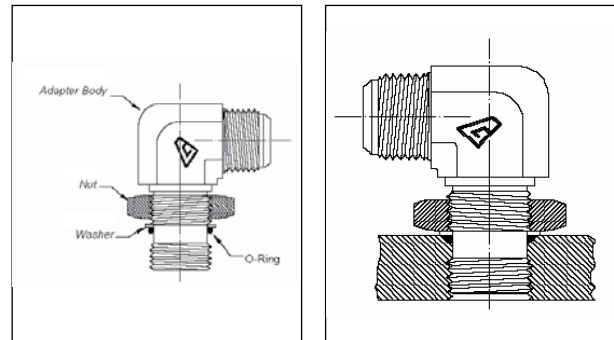

METRIC PORT - ISO 6149 - SAE 2244-1

Metric Thread	D2 ²⁾ min	D3 ³⁾ min	D5 +0,10	D6 +0,50	L1 +0,40	L2 min	L3 max	L4	Z° ±1°	Assembly Torque +10%
D1	mm	mm	mm	mm	mm	mm	mm	mm		Nm
M8x1	17	14	9,1	14	1,6	11,5	1	10	12°	10
M10x1	20	16	11,1	16	1,6	11,5	1	10	12°	20
M12x1,5	23	19	13,8	19	2,4	14	1,5	11,5	15°	35
M14x1,51)	25	21	15,8	21	2,4	14	1,5	11,5	15°	45
M16x1,5	28	24	17,8	24	2,4	15,5	1,5	13	15°	55
M18x1,5	30	28	19,8	26	2,4	17	2	14,5	15°	70
M22x1,5	34	29	23,8	29	2,4	18	2	15,5	15°	100
M27x3	40	34	29,4	34	3,1	22	2	19	15°	170
M33x2	49	43	35,4	43	3,1	22	2,5	19	15°	310
M42x2	60	52	44,4	52	3,1	22,5	2,5	19,5	15°	330
M48x2	66	57	50,4	57	3,1	25	2,5	22	15°	420
M60x2	76	67	52,4	67	3,1	27,5	2,5	24,5	15°	500

- 1) Preferred for diagnostic port application
- 2) Spotface diameter with identification ridge
- 3) Spotface diameter without identification ridge

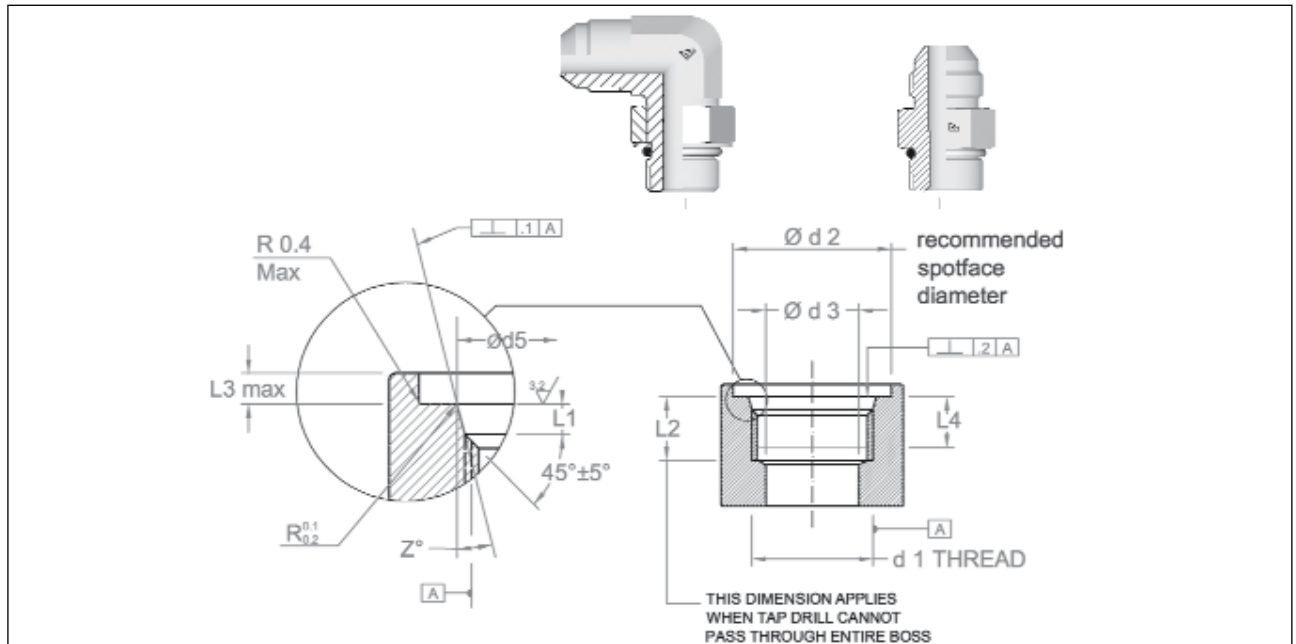

SAE UNF PORT - SAE J1926-1 - ISO 11926

ANSI B1.1	D2	D3 min	D3 +0,13	L1 +0,40	L2 min	L3 max	L4 min	Z° ±1°	Assembly Torque +10%
D1	mm	mm	mm	mm	mm	mm	mm		Nm
7/16"-20	21	4,4	12,4	2,4	14	1,6	11,5	12°	20
1/2"-20	23	6	14	2,4	14	1,6	11,5	12°	25
9/16"-18	25	7,5	15,6	2,5	15,5	1,6	12,7	12°	35
3/4"-16	30	10	20,6	2,5	17,5	2,4	14,3	15°	70
7/8"-14	34	12,5	23,9	3,3	20	2,4	16,7	15°	100
1" 1/16-12	41	16	29,2	3,3	23	2,4	19	15°	170

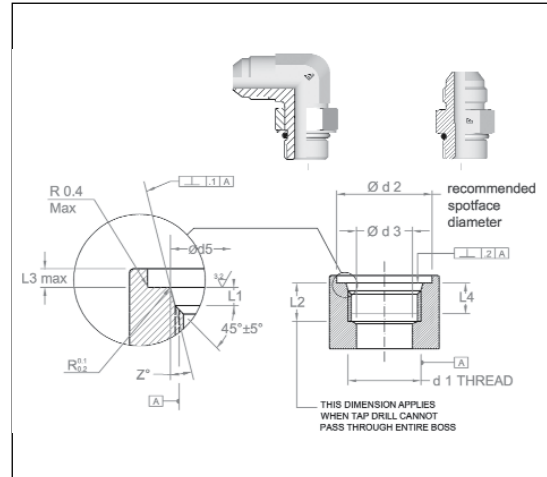
**BSPP PORT - ISO 9974 - DIN 3852-1**

ANSI B1.1 Thread	D3 +0.20	D4	L1 max	L2 min	Assembly Torque +10%
D1	mm	mm	mm	mm	Nm
1/8"-28	9,8	15	1	8	20
1/4"-19	13,2	20	1,5	12	50
3/8"-19	16,7	23	2	12	80
1/2"-14	21	28	2,5	14	100
3/4"-14	26,5	33	2,5	16	200
1"-11	33,3	41	2,5	18	380
1" 1/4-11	42	51	2,5	20	500
1" 1/2-11	47,9	56	2,5	22	600

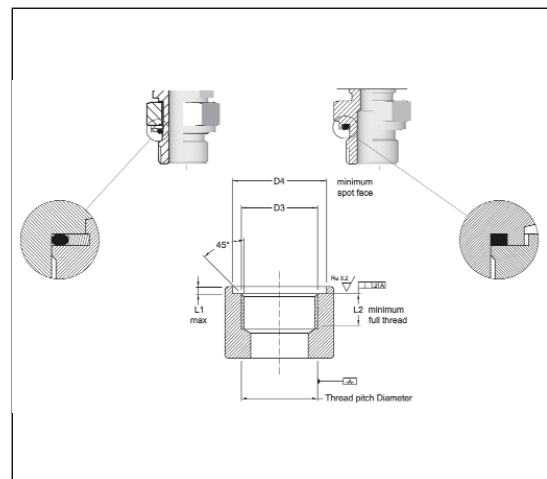
**METRIC_PORT_ISO_9974_DIN_3852_1**

Metric Thread	D3 +0.20	D4 min	L1 max	L2 min	Assembly Torque +10%
D1	mm	mm	mm	mm	Nm
M12x1,5	12	18	1,5	12	35
M14x1,5	14	20	1,5	12	45
M16x1,5	16	23	1,5	12	55
M18x1,5	18	25	2	12	68
M20x1,5	20	27	2	14	80
M22x1,5	22	28	2,5	14	98
M27x2	27	33	2,5	16	180
M33x2	33	41	2,5	18	310
M42x2	42	51	2,5	20	330
M48x2	48	56	2,5	22	400

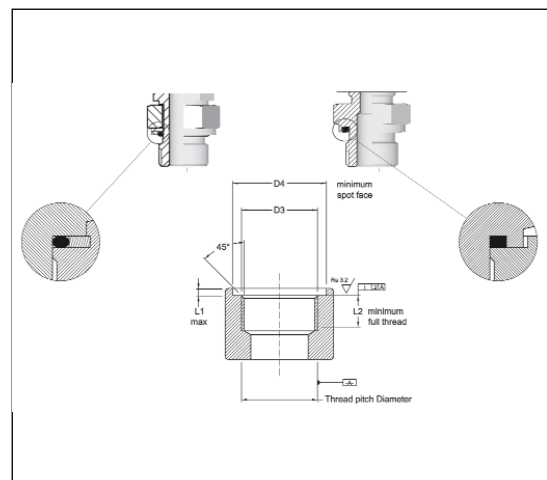

// HYDRAULIC HOSE**// THERMOPLASTIC**

MINIMESS.....	9
FLEXOR 7.....	9
FLEXOR 7 - TWIN.....	10
FLEXOR 8.....	10
FLEXOR TWB1.....	11
FLEXOR TWB1 - TWIN.....	11

// TEXTILE BRAID

ARGUS 1TE/R6 (HF)	12
ARGUS 2TE (HF)	12
ARGUS 3TE/R3 (HF)	13

// WIRE BRAID

2SC RAILWAY.....	14
FLEXOPAK PLT.....	14
FLEXOPAK 1SC.....	15
AT3K - MINETUFF.....	15
FLEXOR 1SN/R1AT (HF)	16
FLEXOR 1SN/R1AT - MINETUFF.....	16
FLEXOR 5.....	17
FLEXOPAK 2SC (HF)	17
FLEXOPAK 2 - MINETUFF.....	18
FLEXOR 2SN/R2AT (HF)	18
FLEXOR 2SN/R2AT - MINETUFF.....	19
FLEXOR ELEVATOR.....	19
ALFAFOREST.....	20

// WIRE SPIRAL

BOP - FIRESAFE 5000.....	21
FLEXOR 4SP.....	21
FLEXOR 4SH.....	22
FLEXOR 12.....	22
FLEXOR 13.....	23
FLEXOR 15 - MINETUFF.....	23
AT7K - MINETUFF.....	24
AT8K - MINETUFF.....	24

// ALFABIOTECH

ALFABIOTECH 2000 - MINETUFF.....	26
ALFABIOTECH 3000 - MINETUFF.....	26
ALFABIOTECH 4000 - MINETUFF.....	27
ALFABIOTECH 5000 - MINETUFF.....	27
ALFABIOTECH 5000 PLUS - MINETUFF.....	28
ALFABIOTECH 6000 - MINETUFF.....	28

// SUPERTUFF

AT3K - SUPERTUFF.....	29
FLEXOPAK 2 - SUPERTUFF.....	29
ALFABIOTECH 5000 - SUPERTUFF.....	30
ALFABIOTECH 6000 - SUPERTUFF.....	30

// HIGH TEMPERATURE

FLEXOPAK 2 HT.....	31
TEMP TECH R5.....	31
TEMP TECH 1SN.....	32
TEMP TECH 2SN.....	32

// LOW TEMPERATURE

FLEXOPAK 2 LT.....	33
ALFAFOREST LT.....	33
FLEXOR 4SP LT.....	34
FLEXOR 4SH LT.....	34

// OIL RETURN LINES

FLEXOR R4 604.....	35
FLEXOR R4 634.....	35
FLEXOR R4 644 HT.....	36

// PRESSURE WASH

ALFAJET 210.....	37
ALFAJET 400.....	37

// PTFE HOSE

9TS OM.....	38
9TC OM.....	39

// HYDRAULIC FITTING**// STANDARD****// FERRULES**

H1100104	Skive Ferrule	47
H1200204	No-skive Ferrule	47
H1100SK1	Skive Ferrule	47
H1100404	Skive Ferrule	47
H1200203	No-skive Ferrule	47
H1200TP0	No-skive Ferrule	47
H2200TF0	No-skive Ferrule	48
H1200AD1	No-skive Ferrule	48
H1200TX2	No-skive Ferrule	48
H1200AD2	No-skive Ferrule	48

// HOSE MENDER

H12C5610	Hose Mender	49
----------	-------------------	----

// BSP INSERTS

H1210510	BSPP Male 60° FlareAGR	50
H1210610	BSPP Male Flat SeatAGR FD	50
H1210710	BSPT MaleAGR K	51
H1220813	BSPP Female 60° Cone with O-RingDKOR	52
H1220843	45° BSPP Female 60° Cone with O-RingDKOR 45Solid one piece	53
H1220893	90° BSPP Female 60° Cone with O-RingDKOR 90Solid one piece	54
H1220581	90° Compact BSPP Female 60° ConeDKR 90	55
H1220613	BSPP Female Flat SeatDKR FD	55
H1230310	BSPP BanjoRNR	56
H10V0210	BSPP Bolt	56

// DIN METRIC INSERTS

H1211110	Metric Male 24° Seat - LightDIN 3853 - CEL	57
H1221513	Metric Female 24° Cone with O-Ring - LightDIN 3865 - DKOL	58
H1221543	45° Metric Female 24° Cone with O-Ring - LightDIN 3865 - DKOL 45Solid one piece	59
H1221593	90° Metric Female 24° Cone with O-Ring - LightDIN 3865 - DKOL 90Solid one piece	60
H1211210	Metric Male 24° Seat - HeavyDIN 3853 - CES	61
H1221613	Metric Female 24° Cone with O-Ring - HeavyDIN 3865 - DKOS	62
H1221643	45° Metric Female 24° Cone with O-Ring - HeavyDIN 3865 - DKOS 45Solid one piece	63
H1221693	90° Metric Female 24° Cone with O-Ring - HeavyDIN 3865 - DKOS 90Solid one piece	64
H1221313	Universal Metric Female	65
H1221343	45° Universal Metric Female	65
H1221393	90° Universal Metric Female	66
H1221013	Metric Female 60° Cone - DIN 3863	66
H1221093	90° Metric Female 60° Cone - DIN 3863Solid one piece	66
H1252010	Metric Straight Standpipe - DIN 2353RSL/RSS	67
H1252040	45° Metric StandpipeRSL 45/RSS 45 - DIN 2353Solid one piece	68
H1252090	90° Metric StandpipeRSL 90/RSS 90 - DIN 2353Solid one piece	69
H1230910	Metric BanjoRNM	70

// HYDRAULIC FITTING

H10V0810 Metric Bolt70

// PRESSURE WASHER

H1224914 Universal Female for Pressure Washer71

// SAE INSERTS

H1213B10 SAE Male Flareless72
 H1226611 SAE Female Swivel 45° Seat72
 H1229710 Female Grease Connection PTF Thread72
 H1213010 SAE Male Solid O-Ring Boss73
 H1213011 SAE Male Swivel O-Ring Boss74
 H1213081 90° Compact SAE Male Swivel O-Ring Boss74

// JIC 37° INSERTS

H1212510 JIC Male 37° Cone AGJ75
 H1222511 JIC Female 37° Seat DKJ76
 H1226511 JIC Female 37° Seat with Stem Hexagon DKJ77
 H1222541-M 45° JIC Female 37° Seat - Medium Drop DKJ 45M Solid one piece78
 H1222591-S 90° JIC Female 37° Seat - Short Drop DKJ 90S Solid one piece79
 H1222591-M 90° JIC Female 37° Seat - Medium Drop DKJ 90M Solid one piece80
 H1222591-L 90° JIC Female 37° Seat - Long Drop DKJ 90L Solid one piece80

// NPTF INSERTS

H1212810 NPTF Male 60° Seat AGN81
 H1222810 NPTF Female Solid82
 H1212811 NPTF Male Swivel 60° Seat82
 H1212881 90° Compact NPTF Male Swivel 60° Seat82

// NPSM INSERTS

H1227311 NPSM Female83

// ORFS INSERTS

H1212410 ORFS Male84
 H1222411 ORFS Female with Stem Hexagon85
 H1222443-M 45° ORFS Female - Medium Drop DK ORFS 45M Solid one piece86
 H1222493-S 90° ORFS Female - Short Drop DK ORFS 90S Solid one piece86
 H1222493-M 90° ORFS Female - Medium Drop DK ORFS 90M Solid one piece87
 H1222493-L 90° ORFS Female - Long Drop DK ORFS 90L Solid one piece87

// FRENCH INSERTS

H1211810 Metric Male French Type88
 H1221813 Metric Female French Type88
 H1221893 90° Metric Female French type88

// JIS INSERTS

H1223711 JIS Female 60° Cone - B 8363 (type C)89
 H1223741 45° JIS Female 60° Cone - B 8363 (type C)89

// HYDRAULIC FITTING

H1223791	90° JIS Female 60° Cone - B 8363 (type C).....	89
H122381Z	JIS Female 60° Seat Flare - B 8363 (type F).....	90
H122384Z	45° JIS Female 60° Seat Flare - B 8363 (type F).....	90
H122389Z	90° JIS Female 60° Seat Flare - B 8363 (type F).....	90

// KOMATSU INSERTS

H1224011	Komatsu Female.....	91
H1244110	Komatsu Flange.....	91
H1244140	45° Komatsu FlangeSolid one piece	92
H1244190	90° Komatsu FlangeSolid one piece	92

// SAE FLANGES

H1243310	Flange SAE 3000 PSI J518 Code 61 - SFL.....	93
H1243320	22° Flange SAE 3000 PSI J518 Code 61 - SFL 22Solid one piece	93
H1243330	30° Flange SAE 3000 PSI J518 Code 61 - SFL 30Solid one piece	94
H1243340	45° Flange SAE 3000 PSI J518 Code 61 - SFL 45Solid one piece	94
H1243360	60° Flange SAE 3000 PSI J518 Code 61 - SFL 60Solid one piece	95
H1243390	90° Flange SAE 3000 PSI J518 Code 61 - SFL 90Solid one piece	95
H1243610	Flange SAE 6000 PSI J518 Code 62 - SFS.....	96
H1243640	45° Flange SAE 6000 PSI J518 Code 62 - SFS 45Solid one piece	96
H1243690	90° Flange SAE 6000 PSI J518 Code 62 - SFS 90Solid one piece	97
H10W3320	Split Flange Clamp 3000 PSI J518 Code 61 - FHL.....	98
H10W3620	Split Flange Clamp 6000 PSI J518 Code 62 - FHS	98
H10W3310	4 Hole Flange Clamp 3000 PSI J518 Code 61 - VHL.....	99
H10W3610	4 Hole Flange Clamp 6000 PSI J518 Code 62 - VHS	99

// MULTISPIRAL**// FERRULES**

H1300SK4	Multispiral Ferrule.....	101
H1300NS6	Multispiral Ferrule.....	101
H1300NS4	Multispiral Ferrule.....	101

// BSP INSERTS

H1310510	BSPP Male 60° FlareAGR.....	102
H1320812	BSPP Female 60° Cone with O-RingDKOR	102
H1320842	45° BSPP Female 60° Cone with O-RingDKOR 45Solid one piece	103
H1320892	90° BSPP Female 60° Cone with O-RingDKOR 90Solid one piece	103

// DIN METRIC INSERTS

H1311210	Metric Male 24° Seat - HeavyDIN 3853 - CES.....	104
H1321613	Metric Female 24° Cone with O-Ring - HeavyDIN 3865 - DKOS	104
H1321643	45° Metric Female 24° Cone with O-Ring - HeavyDIN 3865 - DKOS 45Solid one piece	105
H1321693	90° Metric Female 24° Cone with O-Ring - HeavyDIN 3865 - DKOS 90Solid one piece	105

// HYDRAULIC FITTING**// JIC 37° INSERTS**

H1312510	JIC Male 37° ConeAGJ	106
H1322512	JIC Female 37° SeatDKJ.....	106
H1322542	45° JIC Female 37° Seat - Medium DropDKJ 45MSolid one piece	107
H1322592	90° JIC Female 37° Seat - Medium DropDKJ 90MSolid one piece	107

// NPTF INSERTS

H1312810	NPTF Male 60° SeatAGN.....	108
----------	----------------------------	-----

// ORFS INSERTS

H1312410	ORFS Male	109
H1322411	ORFS Female with Stem Hexagon.....	109
H1322441	45° ORFS Female - Medium DropDK ORFS 45MSolid one piece.....	110
H1322491	90° ORFS Female - Medium DropDK ORFS 90MSolid one piece.....	110

// SAE FLANGES

H1343310	Flange SAE 3000 PSI J518 Code 61 - SFL	111
H1343340	45° Flange SAE 3000 PSI J518 Code 61 - SFL 45Solid one piece	111
H1343390	90° Flange SAE 3000 PSI J518 Code 61 - SFL 90Solid one piece	112
H1343610	Flange SAE 6000 PSI J518 Code 62 - SFS.....	112
H1343640	45° Flange SAE 6000 PSI J518 Code 62 - SFS 45Solid one piece	113
H1343690	90° Flange SAE 6000 PSI J518 Code 62 - SFS 90Solid one piece	113

// SUPERCAT FLANGES

H1343910	Flange SUPERCAT.....	114
H1343940	45° Flange SUPERCATSolid one piece.....	114
H1343990	90° Flange SUPERCATSolid one piece.....	115

// INTERLOCK**// FERRULES**

H1400200	Interlock Ferrule	117
H1400301	Interlock Ferrule	117
H1T00600	Interlock Ferrule	117

// HOSE MENDER

H14C5610	Hose Mender	118
----------	-------------------	-----

// BSP INSERTS

H1410510	BSPP Male 60° FlareAGR.....	119
H1410710	BSPT MaleAGR K.....	119
H1420812	BSPP Female 60° Cone with O-RingDKOR	119
H1420842	45° BSPP Female 60° Cone with O-RingDKOR 45Solid one piece	120
H1420892	90° BSPP Female 60° Cone with O-RingDKOR 90Solid one piece	120

// HYDRAULIC FITTING**// DIN METRIC INSERTS**

H1411210	Metric Male 24° Seat - HeavyDIN 3853 - CES.....	121
H1421613	Metric Female 24° Cone with O-Ring - HeavyDIN 3865 - DKOS	121
H1421643	45° Metric Female 24° Cone with O-Ring - HeavyDIN 3865 - DKOS 45Solid one piece	122
H1421693	90° Metric Female 24° Cone with O-Ring - HeavyDIN 3865 - DKOS 90Solid one piece	122

// JIC 37° INSERTS

H1412510	JIC Male 37° ConeAGJ	123
H1422512	JIC Female 37° SeatDKJ.....	123
H1422542	45° JIC Female 37° SeatDKJ 45Solid one piece	124
H1422592	90° JIC Female 37° SeatDKJ 90Solid one piece	124

// NPTF INSERTS

H1412810	NPTF Male 60° SeatAGN.....	125
----------	----------------------------	-----

// ORFS INSERTS

H1412410	ORFS Male	126
H1422411	ORFS Female with Stem Hexagon.....	126
H1422441	45° ORFS FemaleDK ORFS 45Solid one piece.....	127
H1422491	90° ORFS FemaleDK ORFS 90Solid one piece.....	127

// SAE FLANGES

H1443310	Flange SAE 3000 PSI J518 Code 61 - SFL	128
H1443340	45° Flange SAE 3000 PSI J518 Code 61 - SFL 45Solid one piece	128
H1443390	90° Flange SAE 3000 PSI J518 Code 61 - SFL 90Solid one piece	128
H1443610	Flange SAE 6000 PSI J518 Code 62 - SFS	129
H1443640	45° Flange SAE 6000 PSI J518 Code 62 - SFS 45Solid one piece.....	129
H1443690	90° Flange SAE 6000 PSI J518 Code 62 - SFS 90Solid one piece.....	130
H1T43610	Flange SAE 6000 PSI J518 Code 62 - SFSSpecial version.....	131
H1T43640	45° Flange SAE 6000 PSI J518 Code 62 - SFS 45Solid one pieceSpecial version.....	131
H1T43690	90° Flange SAE 6000 PSI J518 Code 62 - SFS 90Solid one pieceSpecial version.....	131

// SUPERCAT FLANGES

H1443910	Flange SUPERCAT	132
H1443940	45° Flange SUPERCATSolid one piece.....	132
H1443990	90° Flange SUPERCATSolid one piece.....	132

// HAMMER UNION

H1413F13	Male Hammer Union Fig. 1502 integral fitting with Lug Nut.....	133
H1423F10	Female Hammer Union Fig. 1502 integral fitting with Rubber Ring	133
H1T13F13	Male Hammer Union Fig. 1502 integral fitting with Lug NutSpecial version	133
H1T23F10	Female Hammer Union Fig. 1502 integral fitting with Rubber RingSpecial version.....	133

// HYDRAULIC FITTING**// ALFACRIMP C12A****// BSP INSERTS**

C12A10510	BSPP Male 60° FlareAGR.....	135
C12A10710	BSPT MaleAGR K.....	135
C12A20813	BSPP Female 60° Cone with O-RingDKOR.....	136
C12A20843	45° BSPP Female 60° Cone with O-RingDKOR 45Solid one piece.....	136
C12A20893	90° BSPP Female 60° Cone with O-RingDKOR 90Solid one piece.....	137
C12A20581	90° Compact BSPP Female 60° ConeDKR 90.....	137
C12A20613	BSPP Female Flat SeatDKR FD.....	138

// DIN METRIC INSERTS

C12A11110	Metric Male 24° Seat - LightDIN 3853 - CEL.....	139
C12A21513	Metric Female 24° Cone with O-Ring - LightDIN 3865 - DKOL.....	139
C12A21543	45° Metric Female 24° Cone with O-Ring - LightDIN 3865 - DKOL 45Solid one piece.....	140
C12A21593	90° Metric Female 24° Cone with O-Ring - LightDIN 3865 - DKOL 90Solid one piece.....	140
C12A11210	Metric Male 24° Seat - HeavyDIN 3853 - CES.....	141
C12A21613	Metric Female 24° Cone with O-Ring - HeavyDIN 3865 - DKOS.....	141
C12A21643	45° Metric Female 24° Cone with O-Ring - HeavyDIN 3865 - DKOS 45Solid one piece.....	142
C12A21693	90° Metric Female 24° Cone with O-Ring - HeavyDIN 3865 - DKOS 90Solid one piece.....	142
C12A52010	Metric Straight Standpipe - DIN 2353RSL/RSS.....	143

// SAE INSERTS

C12A13B10	SAE Male Flareless.....	144
C12A26611	SAE Female Swivel 45° Seat.....	144
C12A13010	SAE Male SolidO-Ring Boss.....	145
C12A13081	90° Compact SAE Male SwivelO-Ring Boss.....	145

// JIC 37° INSERTS

C12A12510	JIC Male 37° ConeAGJ.....	146
C12A22511	JIC Female 37° SeatDKJ.....	147
C12A26511	JIC Female 37° Seat with Stem HexagonDKJ.....	148
C12A22541-M	45° JIC Female 37° Seat - Medium DropDKJ 45MSolid one piece.....	148
C12A22591-S	90° JIC Female 37° Seat - Short DropDKJ 90SSolid one piece.....	149
C12A22591-M	90° JIC Female 37° Seat - Medium DropDKJ 90MSolid one piece.....	149
C12A22591-L	90° JIC Female 37° Seat - Long DropDKJ 90LSolid one piece.....	150

// NPTF INSERTS

C12A12810	NPTF Male 60° SeatAGN.....	151
C12A22810	NPTF Female Solid.....	151
C12A12811	NPTF Male Swivel 60° Seat.....	152
C12A12881	90° Compact NPTF Male Swivel 60° Seat.....	152

// NPSM INSERTS

C12A27311	NPSM Female.....	153
-----------	------------------	-----

// HYDRAULIC FITTING**// ORFS INSERTS**

C12A12410	ORFS Male	154
C12A22411	ORFS Female with Stem Hexagon.....	154
C12A22443-M	45° ORFS Female - Medium DropDK ORFS 45MSolid one piece.....	155
C12A22493-S	90° ORFS Female - Short DropDK ORFS 90SSolid one piece.....	155
C12A22493-M	90° ORFS Female - Medium DropDK ORFS 90MSolid one piece.....	156
C12A22493-L	90° ORFS Female - Long DropDK ORFS 90LSolid one piece.....	156

// JIS INSERTS

C12A2381Z	JIS Female 60° Seat Flare - B 8363 (type F).....	157
-----------	--	-----

// KOMATSU INSERTS

C12A24011	Komatsu Female.....	158
-----------	---------------------	-----

// SAE FLANGES

C12A43310	Flange SAE 3000 PSI J518 Code 61 - SFL.....	159
C12A43340	45° Flange SAE 3000 PSI J518 Code 61 - SFL 45Solid one piece	159
C12A43390	90° Flange SAE 3000 PSI J518 Code 61 - SFL 90Solid one piece	159
C12A43610	Flange SAE 6000 PSI J518 Code 62 - SFS.....	160
C12A43640	45° Flange SAE 6000 PSI J518 Code 62 - SFS 45Solid one piece.....	160
C12A43690	90° Flange SAE 6000 PSI J518 Code 62 - SFS 90Solid one piece.....	160

// ALFACRIMP C124**// BSP INSERTS**

C12410510	BSPP Male 60° FlareAGR.....	162
C12410710	BSPT MaleAGR K.....	162
C12420813	BSPP Female 60° Cone with O-RingDKOR	163
C12420843	45° BSPP Female 60° Cone with O-RingDKOR 45Solid one piece	163
C12420893	90° BSPP Female 60° Cone with O-RingDKOR 90Solid one piece	164

// DIN METRIC INSERTS

C12411110	Metric Male 24° Seat - LightDIN 3853 - CEL.....	165
C12421513	Metric Female 24° Cone with O-Ring - LightDIN 3865 - DKOL	165
C12421543	45° Metric Female 24° Cone with O-Ring - LightDIN 3865 - DKOL 45Solid one piece	166
C12421593	90° Metric Female 24° Cone with O-Ring - LightDIN 3865 - DKOL 90Solid one piece	166
C12411210	Metric Male 24° Seat - HeavyDIN 3853 - CES.....	167
C12421613	Metric Female 24° Cone with O-Ring - HeavyDIN 3865 - DKOS	167
C12421643	45° Metric Female 24° Cone with O-Ring - HeavyDIN 3865 - DKOS 45Solid one piece	168
C12421693	90° Metric Female 24° Cone with O-Ring - HeavyDIN 3865 - DKOS 90Solid one piece	168

// SAE INSERTS

C12413010	SAE Male SolidO-Ring Boss	169
-----------	---------------------------------	-----

// HYDRAULIC FITTING**// JIC 37° INSERTS**

C12412510	JIC Male 37° ConeAGJ	170
C12422511	JIC Female 37° SeatDKJ.....	170
C12426511	JIC Female 37° Seat with Stem HexagonDKJ.....	171
C12422541-M	45° JIC Female 37° Seat - Medium DropDKJ 45MSolid one piece	171
C12422591-S	90° JIC Female 37° Seat - Short DropDKJ 90SSolid one piece	172
C12422591-M	90° JIC Female 37° Seat - Medium DropDKJ 90MSolid one piece	172
C12422591-L	90° JIC Female 37° Seat - Long DropDKJ 90LSolid one piece	173

// NPTF INSERTS

C12412810	NPTF Male 60° SeatAGN.....	174
C12422810	NPTF Female Solid	174
C12412811	NPTF Male Swivel 60° Seat	175

// ORFS INSERTS

C12412410	ORFS Male	176
C12422411	ORFS Female with Stem Hexagon.....	176
C12422443-M	45° ORFS Female - Medium DropDK ORFS 45MSolid one piece.....	177
C12422493-S	90° ORFS Female - Short DropDK ORFS 90SSolid one piece.....	177
C12422493-M	90° ORFS Female - Medium DropDK ORFS 90MSolid one piece.....	178
C12422493-L	90° ORFS Female - Long DropDK ORFS 90LSolid one piece.....	178

// SAE FLANGES

C12443310	Flange SAE 3000 PSI J518 Code 61 - SFL	179
C12443340	45° Flange SAE 3000 PSI J518 Code 61 - SFL 45Solid one piece	179
C12443390	90° Flange SAE 3000 PSI J518 Code 61 - SFL 90Solid one piece	180
C12443610	Flange SAE 6000 PSI J518 Code 62 - SFS	180
C12443640	45° Flange SAE 6000 PSI J518 Code 62 - SFS 45Solid one piece.....	181
C12443690	90° Flange SAE 6000 PSI J518 Code 62 - SFS 90Solid one piece.....	181

// C122 SAE FLANGES

C12243310	Flange SAE 3000 PSI J518 Code 61 - SFL	182
C12243340	45° Flange SAE 3000 PSI J518 Code 61 - SFL 45Solid one piece	182
C12243390	90° Flange SAE 3000 PSI J518 Code 61 - SFL 90Solid one piece	182

// ALFACRIMP C126**// JIC 37° INSERTS**

C12626512	JIC Female 37° Seat with Stem HexagonDKJ.....	184
C12622542	45° JIC Female 37° SeatDKJ 45Solid one piece	184
C12622592	90° JIC Female 37° SeatDKJ 90Solid one piece	184

// NPTF INSERTS

C12612810	NPTF Male 60° SeatAGN.....	185
-----------	----------------------------	-----

// HYDRAULIC FITTING**// API INSERTS**

C1261281Z	API Male.....	186
-----------	---------------	-----

// ORFS INSERTS

C12622411	ORFS Female with Stem Hexagon.....	187
C12622441	45° ORFS FemaleDK ORFS 45Solid one piece.....	187
C12622491	90° ORFS FemaleDK ORFS 90Solid one piece.....	187

// SAE FLANGES

C12643310	Flange SAE 3000 PSI J518 Code 61 - SFL.....	188
C12643610	Flange SAE 6000 PSI J518 Code 62 - SFS.....	188
C12643640	45° Flange SAE 6000 PSI J518 Code 62 - SFS 45Solid one piece.....	189
C12643690	90° Flange SAE 6000 PSI J518 Code 62 - SFS 90Solid one piece.....	189

// SUPERCAT FLANGES

C12643910	Flange SUPERCAT.....	190
C12643930	30° Flange SUPERCATSolid one piece.....	190
C12643940	45° Flange SUPERCATSolid one piece.....	190
C12643960	60° Flange SUPERCATSolid one piece.....	191
C12643970	67,5° Flange SUPERCATSolid one piece.....	191
C12643990	90° Flange SUPERCATSolid one piece.....	191

// HAMMER UNION

C12R13F13	Male Hammer Union Fig. 1502 Integral Fitting with Lug Nut.....	192
C12R23F10	Female Hammer Union Fig. 1502 Integral Fitting with Rubber Ring.....	192

// HYDRAULIC ADAPTER**// JIC 37° ADAPTERS****// MALE UNION**

R1A25M125M	Straight union JIC - JIC Male	194
R1A25M925M	90° union JIC - JIC Male.....	194
R1A25MT25M	Tee union JIC - JIC Male.....	195
R1A25MX25M	Cross union JIC - JIC Male.....	195

// MALE / FEMALE UNION

R1A253125M	Straight reducing JIC Female - JIC Male	196
R1A25M4251	45° union JIC Male - JIC Female	196
R1A25M9251	90° union JIC Male - JIC Female	197
R1A25MT251	Branch Tee union JIC Male - JIC Female	197
R1A25ML251	Run Tee union JIC Male - JIC Female	198

// BULKHEAD

R1A25M125T	Straight union JIC - JIC Bulkhead	199
R1A25M425T	45° union JIC - JIC Bulkhead.....	199
R1A25M925T	90° union JIC - JIC Bulkhead.....	200
R1A25MT25T	Branch Tee union JIC - JIC Bulkhead	200
R1A25ML25T	Run Tee union JIC - JIC Bulkhead	201

// BSPP

R1A25M105M	Straight connector JIC Male - BSPP cylindric Male 60°	202
R1A25M106I	Straight connector JIC Male - BSPP cylindric Male with elastomer	203
R1A25M106H	Long connector JIC Male - BSPP cylindric Male with elastomer	204
R1A25M406N	45° adjustable elbow connector JIC Male - BSPP cylindric Male with O-Ring and retaining ring.....	205
R1A25M906N	90° adjustable elbow connector JIC Male - BSPP cylindric Male with O-Ring and retaining ring.....	206
R1A25M906Y	90° adjustable long elbow connector JIC Male - BSPP cylindric Male with O-Ring and retaining ring	207
R1A25MT06N	Branch Tee adjustable elbow connector JIC Male - BSPP cylindric Male with O-Ring and retaining ring	208
R1A25ML06N	Run Tee adjustable elbow connector JIC Male - BSPP cylindric Male with O-Ring and retaining ring	209
R1A25M107M	Straight connector JIC Male - BSPT Male.....	210
R1A25M907M	90° elbow connector JIC Male - BSPT Male.....	211

// METRIC

R1A2511525	Straight connector JIC Female - Metric Male with O-Ring	212
R1A25M1525	Straight connector JIC Male - Metric Male with O-Ring.....	213
R1A25M152I	Straight connector JIC Male - Metric Male with elastomer	214
R1A25M152H	Long connector JIC Male - Metric Male with elastomer.....	214
R1A25M952Q	90° adjustable elbow connector JIC Male - Metric Male with O-Ring and retaining ring	215
R1A25M952Y	90° adjustable long elbow connector JIC Male - Metric Male with O-Ring and retaining ring	216
R1A25MT52Q	Branch Tee adjustable elbow connector JIC Male - Metric Male with O-Ring and retaining ring.....	217
R1A25ML52Q	Run Tee adjustable elbow connector JIC Male - Metric Male with O-Ring and retaining ring	217

// SAE UNF

R1A25M1305	Straight connector JIC Male - SAE UNF/UN Male with O-Ring	218
R1A25M130J	Long connector JIC Male - SAE UNF/UN Male with O-Ring	219

// HYDRAULIC ADAPTER

R1A2511305	Straight connector JIC Female - SAE UNF/UN Male with O-Ring	220
R1A25M4305	45° adjustable elbow connector JIC Male - SAE UNF/UN Male with O-Ring	221
R1A25M9305	90° adjustable elbow connector JIC Male - SAE UNF/UN Male with O-Ring	222
R1A25M930J	90° adjustable long elbow connector JIC Male - SAE UNF/UN Male with O-Ring	223
R1A25MT305	Branch Tee adjustable elbow connector JIC Male - SAE UNF/UN Male with O-Ring	224
R1A25ML305	Run Tee adjustable elbow connector JIC Male - SAE UNF/UN Male with O-Ring	225

// NPTF

R1A25M128M	Straight connector JIC - NPTF Male	226
R1A251128M	Straight connector JIC Female - NPTF Male	227
R1A25M428M	45° elbow connector JIC - NPTF Male	227
R1A25M928M	90° elbow connector JIC - NPTF Male	228

// FLANGES

R1A25M133W	Straight flange SAE J518 code 61 - JIC - Low pressure	229
R1A25M136W	Straight flange SAE J518 code 62 - JIC - High pressure	229
R1A25M933W	90° flange SAE J518 code 61 - JIC - Low pressure	230
R1A25M936W	90° flange SAE J518 code 62 - JIC - High pressure	230
R1A25M9334	90° adjustable split flange SAE J518 code 61 - JIC - Low pressure	231
R1A25M9364	90° adjustable split flange SAE J518 code 62 - JIC - High pressure	231

// ACCESSORIES

RXA25D0000	Nut JIC	232
R1A25R0000	Sleeve JIC	232

// PLUG

R1A2531000	Cap JIC Female	233
R1A25M1000	Plug JIC Male	233

// ORFS ADAPTERS**// MALE UNION**

R1A2451245	Straight union ORFS Male	235
R1A2459245	90° union ORFS Male	235
R1A245T245	Branch Tee union ORFS Male	236
R1A245X245	Cross union ORFS Male	236

// MALE / FEMALE UNION

R1A2431245	Straight union ORFS Female - ORFS Male	237
R1A2454241	45° union ORFS Male - ORFS Female	237
R1A2459241	90° union ORFS Male - ORFS Female	238
R1A245T241	Branch Tee union ORFS Male - ORFS Female	238
R1A245L241	Run Tee union ORFS Male - ORFS Female	238

// BULKHEAD

R1A245124T	Straight union ORFS Bulkhead	239
R1A245424T	45° union ORFS Bulkhead	239

// HYDRAULIC ADAPTER

R1A245924T	90° union ORFS Bulkhead	240
R1A245T24T	Branch Tee union ORFS Bulkhead	240
R1A245L24T	Run Tee union ORFS Bulkhead	241

// BSPP

R1A245106I	Straight connector ORFS Male - BSPP cylindric Male with elastomer	242
R1A245406N	45° adjustable elbow connector ORFS Male - BSPP cylindric Male with O-Ring and retaining ring	243
R1A245906N	90° adjustable elbow connector ORFS Male - BSPP cylindric Male with O-Ring and retaining ring	244
R1A245906Y	90° adjustable long elbow connector ORFS Male - BSPP cylindric Male with O-Ring and retaining ring	245
R1A245T06N	Branch Tee adjustable elbow connector ORFS Male - BSPP cylindric Male with O-Ring and retaining ring	245
R1A245L06N	Run Tee adjustable elbow connector ORFS Male - BSPP cylindric Male with O-Ring and retaining ring	246

// METRIC

R1A2451525	Straight connector ORFS Male - Metric Male with O-Ring	247
R1A245152I	Straight connector ORFS Male - Metric Male with elastomer	248
R1A245452Q	45° adjustable elbow connector ORFS Male - Metric Male with O-Ring and retaining ring	249
R1A245952Q	90° adjustable elbow connector ORFS Male - Metric Male with O-Ring and retaining ring	249
R1A245952Y	90° adjustable long elbow connector ORFS Male - Metric Male with O-Ring and retaining ring	250
R1A245T52Q	Branch Tee adjustable elbow connector ORFS Male - Metric Male with O-Ring and retaining ring	250
R1A245L52Q	Run Tee adjustable elbow connector ORFS Male - Metric Male with O-Ring and retaining ring	251

// SAE UNF

R1A2451305	Straight connector ORFS Male - SAE UNF/UN Male with O-Ring	252
R1A245130J	Long connector ORFS Male - SAE UNF/UN Male with O-Ring	252
R1A2454305	45° adjustable elbow connector ORFS Male - SAE UNF/UN Male with O-Ring	253
R1A2459305	90° adjustable elbow connector ORFS Male - SAE UNF/UN Male with O-Ring	254
R1A245930J	90° adjustable long elbow connector ORFS Male - SAE UNF/UN Male with O-Ring	255
R1A2411305	Straight connector ORFS Female - SAE UNF/UN Male with O-Ring	255
R1A245T305	Branch Tee adjustable elbow connector ORFS Male - SAE UNF/UN Male with O-Ring	256
R1A245L305	Run Tee adjustable elbow connector ORFS Male - SAE UNF/UN Male with O-Ring	256

// FLANGES

R1A245133W	Straight flange SAE J518 code 61 - ORFS Male - Low pressure	257
R1A245136W	Straight flange SAE J518 code 62 - ORFS Male - High pressure	257
R1A245933W	90° flange SAE J518 code 61 - ORFS Male - Low pressure	258
R1A245936W	90° flange SAE J518 code 62 - ORFS Male - High pressure	258
R1A2459334	90° adjustable flange SAE J518 code 61 - ORFS Male - Low pressure	259
R1A2459364	90° adjustable flange SAE J518 code 62 - ORFS Male - High pressure	259

// ACCESSORIES

HX0D2403	Nut ORFS	260
----------	----------------	-----

// PLUG

R1A2431000	Cap ORFS Female	261
R1A2451000	Plug ORFS Male	261

// HYDRAULIC ADAPTER**// BSP ADAPTERS****// MALE UNION**

R1A05M105M	Straight union BSP 60° Male	263
R1A05M905M	90° union BSP 60° Male.....	264
R1A05MT05M	Branch Tee union BSP 60° Male	264
R1A05MX05M	Cross union BSP 60° Male.....	264

// MALE / FEMALE UNION

R1A05M1051	Straight union BSP 60° Male - Female.....	265
R1A05M4051	45° union BSP 60° Male - Female	265
R1A05M9051	90° union BSP 60° Male - Female	266
R1A05MT051	Branch Tee union BSP 60° Male - Female.....	266
R1A05ML051	Run Tee union BSP 60° Male - Female.....	266

// FEMALE UNION

R1A0511051	Straight union BSP 60° Female.....	267
R1A0519051	90° union BSP 60° Female	267
R1A051T051	Branch Tee union BSP 60° Female.....	267

// BULKHEAD

R1A05M105T	Straight union BSP 60° Bulkhead.....	268
R1A05M905T	90° elbow connector BSP 60° Bulkhead	268
R1A05MT05T	Branch Tee union BSP 60° Bulkhead	269
R1A05ML05T	Run Tee union BSP 60° Bulkhead	269

// BSPP

R1A05M106N	Straight connector BSP 60° Male - BSPP cylindric Male with O-Ring and retaining ring	270
R1A05M406N	45° adjustable elbow connector BSP 60° Male - BSPP cylindric Male with O-Ring and retaining ring.....	270
R1A05M906N	90° adjustable elbow connector BSP 60° Male - BSPP cylindric Male with O-Ring and retaining ring.....	271
R1A05MT06N	Branch Tee adjustable elbow connector BSP 60° Male - BSPP cylindric Male with O-Ring and retaining ring	271
R1A05ML06N	Run Tee adjustable elbow connector BSP 60° Male - BSPP cylindric Male with O-Ring and retaining ring	272

// FLANGES

R1A05M133W	Straight flange SAE J518 code 61 - BSP - Low pressure	273
R1A05M136W	Straight flange SAE J518 code 62 - BSP - High pressure	273
R1A05M933W	90° flange SAE J518 code 61 - BSP - Low pressure.....	274
R1A05M936W	90° flange SAE J518 code 62 - BSP - High pressure	274
R1A05M9334	90° adjustable flange SAE J518 code 61 - BSP - Low pressure	275
R1A05M9364	90° adjustable flange SAE J518 code 62 - BSP - High pressure.....	275

// PLUG

R1A0531000	Cap BSP 60° Female	276
R1A05M1000	Plug BSP 60° Male	276

// HYDRAULIC ADAPTER**// DIN 24° ADAPTERS****// ACCESSORIES**

R1A11D0000	Nut DIN 24° - Light series.....	278
R1A12D0000	Nut DIN 24° - Heavy series.....	278
R1A11R0000	Double cutting ring DIN 24° - Light series.....	279
R1A12R0000	Double cutting ring DIN 24° - Heavy series.....	279
R1A11R000B	Double cutting ring with tight sealing DIN 24° - Light seriesDIN 2353.....	280
R1A12R000B	Double cutting ring with tight sealing DIN 24° - Heavy seriesDIN 2353.....	280

// MALE UNION

R1A11M111M	Straight union DIN 24° Male - Light series.....	281
R1A12M112M	Straight union DIN 24° Male - Heavy series.....	281
R1A11M911M	90° union DIN 24° Male - Light series.....	282
R1A12M912M	90° union DIN 24° Male - Heavy series.....	282
R1A11MT11M	Branch Tee union DIN 24° Male - Light series.....	283
R1A12MT12M	Branch Tee union DIN 24° Male - Heavy series.....	283
R1A11MX11M	Cross union DIN 24° Male - Light series.....	284
R1A12MX12M	Cross union DIN 24° Male - Heavy series.....	284

// MALE / FEMALE UNION

R1A11M1113	Reducers DIN 24° pre-assembled - Light series.....	285
R1A12M1123	Reducers DIN 24° pre-assembled - Heavy series.....	286
R1A11M1152	Reducers DIN 24° with O-Ring - Light series.....	287
R1A12M1162	Reducers DIN 24° with O-Ring - Heavy series.....	288
R1A11M4152	45° adjustable elbow connector DIN 24° Male - Female with O-Ring - Light series.....	289
R1A12M4162	45° adjustable elbow connector DIN 24° Male - Female with O-Ring - Heavy series.....	289
R1A11M9113	90° adjustable elbow connector DIN 24° Male - Female pre-assembled - Light series.....	290
R1A12M9123	90° adjustable elbow connector DIN 24° Male - Female pre-assembled - Heavy series.....	290
R1A11M9152	90° adjustable elbow connector DIN 24° Male - Female with O-Ring - Light series.....	291
R1A12M9162	90° adjustable elbow connector DIN 24° Male - Female with O-Ring - Heavy series.....	291
R1A11MT113	Branch Tee adjustable elbow connector DIN 24° Male - Female pre-assembled - Light series.....	292
R1A12MT123	Branch Tee adjustable elbow connector DIN 24° Male - BSPP Male with O-Ring - Heavy series.....	292
R1A11MT152	Branch Tee adjustable elbow connector DIN 24° Male - Female with O-Ring - Light series.....	293
R1A12MT162	Branch Tee adjustable elbow connector DIN 24° Male - Female with O-Ring - Heavy series.....	293
R1A11ML113	Run Tee adjustable elbow connector DIN 24° Male - Female pre-assembled - Light series.....	294
R1A12ML123	Run Tee adjustable elbow connector DIN 24° Male - Female pre-assembled - Heavy series.....	294
R1A11ML152	Run Tee adjustable elbow connector DIN 24° Male - Female with O-Ring - Light series.....	295
R1A12ML162	Run Tee adjustable elbow connector DIN 24° Male - Female with O-Ring - Heavy series.....	295

// BULKHEAD

R1A11T111M	Straight union DIN 24° Bulkhead - Light series.....	296
R1A12T112M	Straight union DIN 24° Bulkhead - Heavy series.....	296
R1A11T911M	90° union DIN 24° Bulkhead - Light series.....	297
R1A12T912M	90° union DIN 24° Bulkhead - Heavy series.....	297

// HYDRAULIC ADAPTER

// METRIC

R1A11M150M	Straight connector DIN 24° Male - Metric cylindric Male - Light series.....	298
R1A12M150M	Straight connector DIN 24° Male - Metric cylindric Male - Heavy series.....	298
R1A11M950M	90° elbow connector DIN 24° Male - Metric cylindric Male - Light series.....	299
R1A12M950M	90° elbow connector DIN 24° Male - Metric cylindric Male - Heavy series.....	299
R1A11M452Q	45° adjustable elbow connector DIN 24° Male - Metric Male with O-Ring and retaining ring - Light series.....	300
R1A12M452Q	45° adjustable elbow connector DIN 24° Male - Metric Male with O-Ring and retaining ring - Heavy series.....	300
R1A11M952Q	90° adjustable elbow connector DIN 24° Male - Metric Male with O-Ring and retaining ring - Light series.....	301
R1A12M952Q	90° adjustable elbow connector DIN 24° Male - Metric Male with O-Ring and retaining ring - Heavy series.....	301
R1A11MT52Q	Branch Tee adjustable elbow connector DIN 24° Male - Metric Male with O-Ring and retaining ring - Light series.....	302
R1A12MT52Q	Branch Tee adjustable elbow connector DIN 24° Male - Metric Male with O-Ring and retaining ring - Heavy series.....	302
R1A11ML52Q	Run Tee adjustable elbow connector DIN 24° Male - Metric Male with O-Ring and retaining ring - Light series.....	303
R1A12ML52Q	Run Tee adjustable elbow connector DIN 24° Male - Metric Male with O-Ring and retaining ring - Heavy series.....	303
R1A11M152I	Straight connector DIN 24° Male - Metric cylindric Male with elastomer - Light series.....	304
R1A12M152I	Straight connector DIN 24° Male - Metric cylindric Male with elastomer - Heavy series.....	304
R1A113152I	Straight connector DIN 24° Female pre-assembled - Metric cylindric Male with elastomer - Light series.....	305
R1A123152I	Straight connector DIN 24° Female pre-assembled - Metric cylindric Male with elastomer - Heavy series.....	305
R1A152152I	Straight connector DIN 24° Female with O-Ring - Metric cylindric Male with elastomer - Light series.....	306
R1A162152I	Straight connector DIN 24° Female with O-Ring - Metric cylindric Male with elastomer - Heavy series.....	306
R1A11M962M	90° elbow connector DIN 24° Male - Metric conic Male - Light series.....	307
R1A12M962M	90° elbow connector DIN 24° Male - Metric conic Male - Heavy series.....	307
R1A11ME505	Banjo adjustable - Type A - Metric cylindric DIN 24° - Light series.....	308
R1A12ME505	Banjo adjustable - Type A - Metric cylindric DIN 24° - Heavy series.....	308
R1A11ME50M	Banjo adjustable - Type B - Metric cylindric DIN 24° - Light series.....	309
R1A12ME50M	Banjo adjustable - Type B - Metric cylindric DIN 24° - Heavy series.....	309

// BSPP

R1A11M106M	Straight connector DIN 24° Male - BSPP cylindric flat Male - Light series.....	310
R1A12M106M	Straight connector DIN 24° Male - BSPP cylindric flat Male - Heavy series.....	310
R1A11M106F	Straight connector DIN 24° Male - BSPP cylindric Female - Light series.....	311
R1A12M106F	Straight connector DIN 24° Male - BSPP cylindric Female - Heavy series.....	311
R1A11M106I	Straight connector DIN 24° Male - BSPP cylindric Male with elastomer - Light series.....	312
R1A12M106I	Straight connector DIN 24° Male - BSPP cylindric Male with elastomer - Heavy series.....	312
R1A11M406N	45° adjustable elbow connector DIN 24° Male - BSPP cylindric Male with O-Ring and retaining ring - Light series.....	313
R1A12M406N	45° adjustable elbow connector DIN 24° Male - BSPP cylindric Male with O-Ring and retaining ring - Heavy series.....	313
R1A11M906N	90° adjustable elbow connector DIN 24° Male - BSPP cylindric Male with O-Ring and retaining ring - Light series.....	314
R1A12M906N	90° adjustable elbow connector DIN 24° Male - BSPP cylindric Male with O-Ring and retaining ring - Heavy series.....	314
R1A11MT06N	Branch Tee adjustable elbow connector DIN 24° Male - BSPP Male with O-Ring and retaining ring - Light series.....	315
R1A12MT06N	Branch Tee adjustable elbow connector DIN 24° Male - BSPP Male with O-Ring and retaining ring - Heavy series.....	315
R1A11ML06N	Run Tee adjustable elbow connector DIN 24° Male - BSPP Male with O-Ring and retaining ring - Light series.....	316
R1A12ML06N	Run Tee adjustable elbow connector DIN 24° Male - BSPP Male with O-Ring and retaining ring - Heavy series.....	316
R1A152106I	Straight connector DIN 24° Female with O-Ring - BSPP cylindric Male with elastomer - Light series.....	317
R1A162106I	Straight connector DIN 24° Female with O-Ring - BSPP cylindric Male with elastomer - Heavy series.....	317
R1A113106I	Straight connector DIN 24° Female pre-assembled - BSPP cylindric Male with elastomer - Light series.....	318
R1A123106I	Straight connector DIN 24° Female pre-assembled - BSPP cylindric Male with elastomer - Heavy series.....	318
R1A11ME06M	Banjo elbow - Type B - BSPP Male DIN 24° - Light series.....	319
R1A12ME06M	Banjo elbow - Type B - BSPP Male DIN 24° - Heavy series.....	319

// HYDRAULIC ADAPTER

R1A11ME035	Banjo elbow - Type A - BSPP Male DIN 24° - Light series	320
R1A12ME035	Banjo elbow - Type A - BSPP Male DIN 24° - Heavy series.....	320
R1A06F106I	Straight connector BSPP Female - BSPP Male with elastomer.....	321

// BSPT

R1A11M107M	Straight connector DIN 24° Male - BSPT cylindric flat Male - Light series	322
R1A12M107M	Straight connector DIN 24° Male - BSPT cylindric flat Male - Heavy series.....	323
R1A11M907M	90° connector DIN 24° Male - BSPT Male - Light series	324
R1A12M907M	90° connector DIN 24° Male - BSPT Male - Heavy series.....	324
R1A11MT07M	Branch Tee connector DIN 24° Male - BSPT Male - Light series	325
R1A12MT07M	Branch Tee connector DIN 24° Male - BSPT Male - Heavy series	325
R1A11ML07M	Run Tee connector DIN 24° Male - BSPT Male - Light series.....	326
R1A12ML07M	Run Tee connector DIN 24° Male - BSPT Male - Heavy series	326

// BUTT WELD

R1A11M100S	Butt Weld straight coupling DIN 24° - Light series.....	327
R1A12M100S	Butt Weld straight coupling DIN 24° - Heavy series.....	327
R1A11M111S	Butt Weld long straight coupling DIN 24° - Light series	328
R1A12M112S	Butt Weld long straight coupling DIN 24° - Heavy series	328

// PLUG

R1A15F0000	Plug with O-Ring 24° DIN 2353 - Light series	329
R1A16F0000	Plug with O-Ring 24° DIN 2353 - Heavy series	329
R1A50I0000	Socket head plug Metric cylindric with elastomer	330
R1A06I0000	Socket head plug BSPP cylindric with elastomer.....	330



HEADQUARTER

Alfagomma SpA

Via Torri Bianche 1

20871 Vimercate (MB) Italy

marketing@alfagomma.com

www.alfagomma.com