



ALFAGOMMA

MINING



HOSE / FITTINGS / ADAPTERS





HYDRAULIC HOSE

TEXTILE BRAID35
 WIRE BRAID36
 WIRE SPIRAL39
 ALFATECH41
 HIGH TEMPERATURE47
 OIL RETURN LINES48

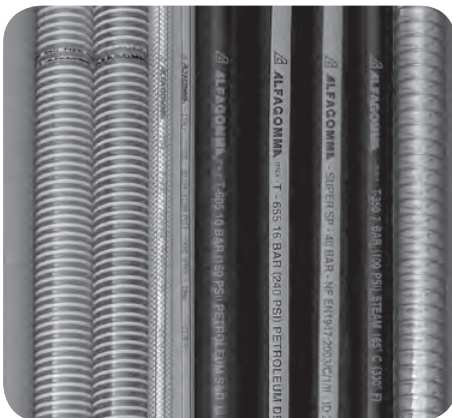

INDUSTRIAL HOSE

MINING - COMPRESSED AIR53
 MINING - WATER & LIQUIDS55
 MINING - CONCRETE56
 MINING - ACID, CHEMICAL & MULTIPURPOSE57
 MINING - HYDROCARBONS58
 MINING59



FERRULES

FERRULE SELECTION CHART66
 STANDARD FERRULES70
 INTERLOCK FERRULES71



INSERTS

RAPID STAPLE-LOCK INSERTS - STANDARD78
 RAPID STAPLE-LOCK INSERTS - INTERLOCK80
 SUPER RAPID STAPLE-LOCK INSERTS - INTERLOCK81
 COMPACT INSERTS - STANDARD82
 COMPACT INSERTS - INTERLOCK83



ADAPTERS

RAPID STAPLE-LOCK ADAPTERS96
 SUPER RAPID STAPLE-LOCK ADAPTERS120
 COMPACT ADAPTERS131
 BULKHEAD ADAPTERS.....135



ACCESSORIES

RAPID ACCESSORIES.....144
 SUPER RAPID ACCESSORIES146
 COMPACT ACCESSORIES148
 GENERAL ACCESSORIES.....149

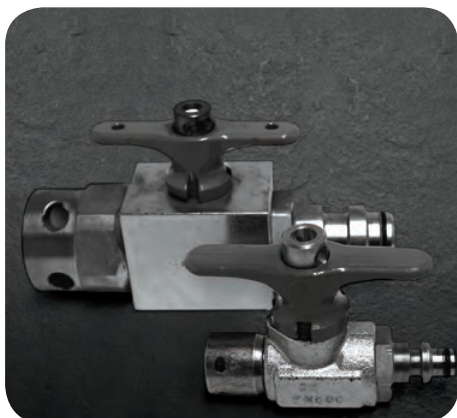

BALL VALVES

RAPID STAPLE-LOCK BALL VALVES153
 SUPER RAPID STAPLE-LOCK BALL VALVES154
 BALL VALVES HANDLE OPTIONS156

CHART SYMBOLS

	Internal diameter		Minimum bend radius
	Outside diameter		Wall thickness
	Maximum working pressure		Weight
	Minimum burst pressure		Vacuum

Alfagomma reserves the right to change technical information in the content of this catalogue without prior notice.

SETTING NEW STANDARDS

ALFAGOMMA is a company that supports Corporate Social Responsibility initiatives and as such adopts environmentally conscious manufacturing methods and product design. A variety of environmental problems are now affecting the entire world and as such the environmental challenges facing industrial companies and governments around the world are numerous and complex. In attempting to make a contribution to find an answer to these challenges, ALFAGOMMA has introduced a replacement of its standard range of hydraulic hose with an HF range of environmental friendly halogen free hose that does not contain Chlorine, Fluorine and Iodine.

DESIGN

Throughout the world ALFAGOMMA has build up a name synonymous with quality, and a reputation based on its range of first class products, a commitment to research and development and ongoing capital investment in the latest manufacturing technology. Through continuous research and development, ALFAGOMMA continues to introduce innovative fluid conveying products that offer better performance and cost saving to our customers. ALFAGOMMA hose and couplings are designed to work together as a matched system for providing problem free performance, no matter what equipment it operates on. The performance of all our products meets or exceeds the ISO, EN, SAE, JIS International Norms and certain hoses have an extremely high abrasion resistance cover which meets the MSHA and LOBA flame resistance requirements.

LEADERSHIP IN HYDRAULIC HOSE AND COUPLING COMPONENTS

ALFAGOMMA has developed into a world leading manufacturer of fluid connector components of fluid power systems. A committed approach towards the requisites from OEMs for products that require special performance for severe applications has resulted in ALFAGOMMA continuously introducing an innovative range of hydraulic hose and couplings. These products are widely used and accepted in all the major industries such as:

- Mining
- Construction / Earthmoving
- Injection & Compression Moulding
- Forestry Agriculture
- Drilling / Piling
- Petroleum
- Waste/Refuse
- Lifting Equipment
- Railroad
- Special Purpose Vehicles
- Cargo Handling

GLOBAL PRESENCE

Alfagomma with a world wide presence in 18 countries through its 85 Sales & Distribution and OEM Hose Assembly facilities together with its Distributor network is able to guarantee a global supply solution to its customers.

MATCHED COMPONENTS PROGRAMME

The Alfagomma range of hose and fittings are designed, engineered and tested to be used as a matched pair when making hose assemblies. The use of Alfagomma fittings on other manufacturer's hose or the use of Alfagomma hose with other manufacturer's fittings may result in the production of unreliable, unsafe, non performing hose assemblies. It is therefore neither recommended nor authorised by Alfagomma.



REFERENCE SPECIFICATIONS

SAE-	Society of Automotive Engineers	MSHA-	U.S. Mine Safety and Health Administration
DNV-	Det Norske Veritas	LOBA-	Landesoberamt Nordrhein-Westfalen
EN-	European Norm	AS-	Australian Standard
DIN-	Deutsches Institut für Normung	BV-	Bureau Veritas
CERCHAR-	Centre d'Etudes et Recherches Des Charbonnages de France	GL-	Germanischer Lloyd
		ISO-	International Organization for Standardization

The listing below are intended only as guides in identifying which ALFAGOMMA hoses comply with requirements of various agencies.

HOSE TYPE	SAE J517	EN	ISO	AG ¹	DNV ²	ABS	GIG	GL	BV	NKK	RINA	MSHA ³	USDOT ⁴
Flexor 2TE		854 2TE											
Flexor 3TE		854 3TE											
Flexor 3	100 R3	854 R3											
Flexor 6	100 R6	854 R6											
Flexor 7	100 R7	855 R7	3949 R7										
Flexor 1SN-R1AT	100 R1AT	853 1SN	1436 1SN-R1AT		X	X		X	X	X	X	X	
Flexor 2SN-R2AT	100 R2AT	853 2SN	1436 2SN-R2AT		X	X	X	X	X	X	X	X	
Flexor 2ST-R2A	100 R2A	853 2ST	1436 2ST		X	X	X	X	X		X	X	
Flexor 5	100 R5												X
Flexopak PLT				X									
Flexopak 1SC		857 1SC											
Flexopak 16			11237 R16										
Flexopak 2SC	100 R16	857 2SC	11237 2SC		X		X		X		X		
Flexopak 3				X									
Flexor 4SP		856 4SP	3862 4SP		X		X		X	X	X	X	
Flexor 4SH		856 4SH	3862 4SH		X			X	X	X	X	X	
Flexor 12	100 R12		3862 R12		X					X	X	X	
Flexor 13	100 R13		3862 R13		X				X	X	X	X	
Alfatech 3K	100 R17			X								X	
Alfatech 4K	100 R19			X								X	
Alfatech 5K				X								X	
Alfatech 6K	100 R15			X	X	X			X		X	X	
Alfatech 7K				X								X	
Alfatech 8K				X								X	
Flexopak 2LT				X									
Flexopak 3LT				X									
Temp Tech 1SN				X									
Temp Tech 2SN				X									
Flexor 1SN-HT				X									
Flexor 4	100 R4												
Alfajet 210				X									
Alfajet 280				X									
Alfajet 315				X									
Alfajet 400				X									
Alfajet 500				X									

1- Alfagomma Proprietary Hose

2- DNV approvals are for hose assemblies only

3- Hose with MSHA approved cover is branded accordingly

4- DOT Type All TYPE All FMVSS 106 approval up to size -12

Listing may vary by style and size, for current and complete information, contact ALFAGOMMA for details.

SAFETY GUIDE AND BASIC FACTORS FOR THE SELECTION, INSTALLATION AND MAINTENANCE OF HOSE AND HOSE ASSEMBLIES

Hydraulic hose (and hose assemblies) has a limited life dependent on service conditions to which is applied. Subjecting hose (and hose assemblies) to conditions more severe than the recommended limits significantly reduce service life. Exposure to combinations of recommended limits (i.e., continuous use at maximum rated working pressure, maximum recommended operating temperature and minimum bend radius) will also reduce service life.

WARNING: FAILURE TO FOLLOW PROPER SELECTION, INSTALLATION AND MAINTENANCE PROCEDURES MAY RESULT IN PREMATURE FAILURES, BODILY INJURY, AND DAMAGE TO PROPERTY.

1. SELECTION-The following is a list of factors which must be considered before the selection of a hose can be made:

1.1 Line size:

In order to achieve maximum efficiency in a hydraulic system, it is necessary to keep pressure losses (resistance to the volumetric flow) to a minimum when a fluid is conveyed by the different types of flow lines.

When a fluid flows through a flow line, heat is generated by friction. Thus part of the energy is lost as heat energy, which results in a pressure loss.

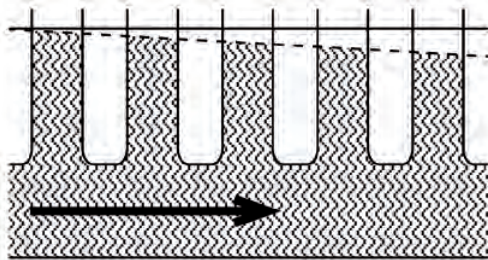

These pressure losses depend upon:

- flow velocity (for a given volumetric flow, the fluid flow velocity increases with a decrease in the cross sectional area of a flow line and vice versa)
- length of the flow line
- the viscosity of the fluid flowing
- the density of the fluid flowing
- the type of flow (laminar or turbulent)

Types of flow-The type of flow changes from laminar to turbulent at a certain flow velocity. This velocity is given by the Reynold's Number Re.

For cylindrical flow lines the following formula applies:

$$Re = \frac{v \times d}{\nu}$$
 Where v = velocity (m/s)
 d = flow line internal dia (m)
 ν = kinematic viscosity (m²/s)

As soon as the value for Re exceeds 2300, the laminar flow changes to turbulent flow.

Laminar flow-In laminar flow, the individual fluid particles move up to certain speeds in uniform layers alongside each other. They scarcely disturb or influence each other.

Turbulent flow-If the value for Re exceeds 2300, flow becomes whirling and turbulent. The individual particles no longer move in one direction in an orderly fashion, but influence and hinder each other.

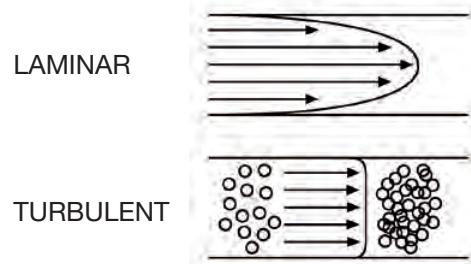

Certain fluid flow velocities have proved to be most suitable for hydraulic flow lines.

Recommended flow velocities:

Suction lines:	0.5 ... 1.2 m/s	1.6 ... 4 feet/s
Return lines:	2.0 ... 3.0 m/s	6.5...10 feet/s
Pressure lines:	4.0 ... 7.5 m/s	13...25 feet/s

It is therefore important to calculate correctly the required flow line sizes. Undersized pressure lines results in high fluid velocity causing an excessive pressure drop, and heat built up, which impair overall system performance. Undersized suction lines can cause cavitation at the hydraulic pump inlet, affecting performance, shortening pump life, and creating excessive noise levels.

The flow capacity normogram on page (49) is an aid to determine the correct hose internal diameter size, desired flow rate and recommended velocity. By the use of any two known factors, the third can be determined.

1.2 Pressure:

After determining the system pressure for a hydraulic system, hose selection must be made so that the recommended maximum operating pressure specified by a given hose, is equal or greater than the system pressure. Dynamic pressure is common for all hydraulic systems. Pressure surges which exceed the maximum working pressure (pressure relief valve setting) affect the service life of system components, including a hose assembly and therefore need to be taken into consideration. Hoses used for suction lines must be selected to ensure the hose will withstand the negative pressure of the system.

1.3 Temperature:

Care must be taken to ensure that the operating temperature of the fluid being conveyed and ambient temperatures, do not exceed the limitations of the hose. Special care must be taken when routing near hot manifolds or molten metal.

1.4 Fluid Compatibility:

Hose selection must assure compatibility of the hose tube, cover, reinforcement, and fittings with the fluid used. Additional caution must be observed in hose selection for gaseous applications. Some fire resistant fluids require the same hose as petroleum oil. Some use a special hose, while a few fluids will not work with any hose at all.

1.5 Permeation:

Permeation (that is, seepage through the hose) will occur from inside the hose to outside when hose is used with gases, liquid and gas fuels, and refrigerants (including but not limited to such materials such as helium, fuel oil, natural gas or freon). This permeation may result in high concentrations of vapours which are potentially flammable, explosive, or toxic and in loss of fluid.

Even though the fluid compatibility is acceptable, you must take into account the fact that permeation will occur and could be hazardous. Permeation of moisture from outside the hose to inside the hose will also occur. If this moisture permeation would have detrimental effects (particularly but not limited to refrigeration and air conditioning systems), incorporation of sufficient drying capacity in the system or other appropriate system safeguards should be selected and used.

1.6 Routing:

Attention must be given to optimum routing to minimise inherent problems. Restrain, protect or guide hose with the use of clamps if necessary to minimise risk or damage due to excessive flexing, whipping or contact with other moving parts or corrosives. Determine hose lengths and configurations that will result in proper routing and protection from abrasion, snagging or kinking and provide leak resistant connections.

1.7 Environment:

Care must be taken to ensure that the hose and fittings are either compatible with or protected from the environment to which they are exposed. Environmental conditions including but not limited to ultraviolet light, heat, ozone, moisture, water, salt water, chemicals, and air pollutants can cause degradation and premature failure and, therefore, must be considered.

1.8 Mechanical Loads:

External forces can significantly reduce hose life. Mechanical loads which must be considered include excessive flexing, twist, kinking, tensile or side loads, bend radius, and vibration. Use of swivel type fittings or adapters may be required to ensure no twist is put into the hose. Unusual applications may require special testing prior to hose selection.

1.9 Abrasion:

While a hose is designed with a reasonable level of abrasion resistance, care must be taken to protect the hose from excessive abrasion which can result in erosion, snagging, and cutting of the hose cover. Exposure of the reinforcement will significantly accelerate hose failure.

1.10 Proper End Fitting:

Care must be taken to ensure proper compatibility exists between the hose and coupling selected based on the manufacturer's recommendations substantiated by testing to industry standards such as SAE J517 EN, ISO.

1.11 Length:

When establishing proper hose length, motion absorption, hose length changes due to pressure, as well as hose and machine tolerances must be considered.

1.12 Specifications and Standards:

When selecting hose and fittings, government, industry, and manufacturer's specifications and recommendations must be reviewed as applicable.

1.13 Hose Cleanliness:

Hose components may vary in cleanliness levels. Care must be taken to ensure that the assemblies selected have an adequate level of cleanliness for the application.

1.14 Welding and Brazing:

Heating of plated parts, including hose fittings and adapters, above 232° C (450° F) such as during welding, brazing, or soldering may emit deadly gases.

1.15 Electrical Conductivity:

Certain applications require that a hose be non-conductive to prevent electrical current flow. Other applications require the hose to be sufficiently conductive to drain off static electricity.

Extreme care must be exercised when selecting hose and fittings for these or any other applications in which electrical conductivity or non-conductivity is a factor.

For applications that require hose to be electrically non-conductive, including but not limited to applications near high voltage electric lines, only special non-conductive hose can be used.

The manufacturer of the equipment in which the non-conductive hose is to be used must be consulted to be certain that the hose and fittings that are selected are proper for the application.

Do not use any **ALFAGOMMA** hose or fitting for any application requiring non-conductive hose, including but not limited to applications near high voltage electric lines, unless the application is expressly approved in the **ALFAGOMMA** technical publication for the product, the non conductive is both orange in colour and marked "non-conductive", and the manufacturer of the equipment on which the hose is to be used specifically approves the particular **ALFAGOMMA** hose and fitting for such use.

ALFAGOMMA does not supply any hose or fittings for conveying paint in airless paint spraying or similar applications and therefore should not be used. A special hose and fitting assembly is required for this application, to avoid static electricity buildup which could cause a spark that may result in an explosion and/or fire.

The electrical conductivity or non-conductivity of hose and fittings is dependant upon many factors and may be susceptible to change. These factors include but are not limited to the various materials used to make the hose and the fittings, manufacturing methods (including moisture control), how the fittings make contact with the hose, age and amount of deterioration or damage or other changes, moisture content of the hose at and particular time, and others factors.

HOSE GUIDELINE



2. INSTALLATION-After the selection of the correct hose, the following factors must be considered prior to hose and fitting assembly and installation.

2.1 Pre-Installation Inspection:

Prior to installation, a careful examination of the hose must be performed. All components must be checked for correct style, size, and length. The hose must be examined for cleanliness, obstructions, cover condition, or any leaks. or any other visible defects.

2.2 Hose and Fitting Assembly:

Do not use any **ALFAGOMMA** fluid connector components (including but not limited to ferrules or inserts) except with the correct matching **ALFAGOMMA** component in accordance with **ALFAGOMMA**'s published hose assembly instructions.

2.3 Related Accessories:

Crimp or swage **ALFAGOMMA** hose or fittings only with **ALFAGOMMA** approved swage or crimp machines and in accordance with the **ALFAGOMMA** published hose assembly instructions.

2.4 Parts:

Do not use any **ALFAGOMMA** hose fitting part (including but not limited to sockets, or inserts) except with the correct **ALFAGOMMA** mating parts, in accordance with **ALFAGOMMA** published hose assembly

2.5 Reusable/Permanent:

Do not reuse any reusable hose coupling that has blown or pulled off a hose. Do not reuse an **ALFAGOMMA** permanent (that is, crimped or swaged) hose fitting or any part thereof.

2.6 Minimum Bend Radius:

Installation of a hose at less than the minimum listed bend radius may significantly reduce the hose life. Particular attention must be given to avoid sharp bending at the hose/ fitting juncture.

2.7 Twist Angle and Orientation:

Hose installations must be such that relative motion of machine components does not produce twisting.

2.8 Securement:

In many applications, it may be necessary to restrain, protect, or guide the hose to protect it from damage by unnecessary flexing, pressure surges, and contact with other mechanical components. Care must be taken to ensure such restraints do not introduce additional stress or wear points.

2.9 Proper Connection of Ports:

Proper physical installation of the hose requires a correctly installed port connection while ensuring that no twist or torque is transferred to the hose.

2.10 External Damage:

Proper installation is not complete without ensuring that

tensile loads, side loads, kinking, flattening, potential abrasion, thread damage, or damage to sealing surfaces are corrected or eliminated.

2.11 System Checkout:

After completing the installation, all the entrapped air must be eliminated by correctly bleeding the system after which it can be pressurised to the maximum system pressure and checked for proper function without any leaks.any leaks. Personnel must stay out of potential hazardous areas while testing.

3. HOSE AND FITTING MAINTENANCE INSTRUCTIONS

Even with proper selection and installation, hose life may be significantly reduced without a continuing maintenance program. Frequency should be determined by the severity of the application and risk potential. A maintenance program must be established and followed to include the following as a minimum:

3.1 Visual Inspection Hose/Fitting:

Any of the following conditions require immediate shut down and replacement of the hose assembly:

- Fitting slippage on hose.
- Damaged, cut or abraded cover (any reinforcement exposed).
- Hard, stiff, heat cracked, or charred hose.
- Cracked, damaged, or badly corroded fittings.
- Leaks at fitting or in hose.
- Kinked, crushed, flattened or twisted hose.
- Blistered, soft, degraded, or loose cover.

3.2 Visual Inspection all other:

The following items must be tightened, repaired or replaced as required:

- Leaking port conditions
- Remove excess dirt build-up
- Clamp, guards, shields
- System fluid level, fluid type and any air entrapment

3.3. Functional Test:

Operate the system at maximum operating pressure and check for possible malfunctions and freedom from leaks. Personnel must stay out of potential hazardous areas while testing.

3.4 Replacement Intervals:

Specific replacement intervals must be considered based on previous service life, government or industry recommendations, or when failures could result in unacceptable downtime, damage, or injury risk.

FLOW / VELOCITY NOMOGRAM (METRIC)

The nomogram is based on the following formula:

$$d = \sqrt{\frac{Q \times 21.22}{v}}$$

Where Q = Flow (l/min)
v = Velocity (m/s)
d = Hose ID (mm)

Use the nomogram below to determine the Hose ID (d) based on the Flow (Q) and Fluid Velocity (v). Conversely, it can be used to determine the Velocity (v), based on Flow (Q) and Hose ID (d), or the Flow (Q) based on Velocity (v) and Hose ID (d).

To use the nomogram, draw a straight line across the entire nomogram, intersecting the scale for the two known quantities.

In the example shown, considering an application with a Flow of 150 l/min and a desired Velocity of 5 m/s by drawing a straight line to intersect these two known quantities, the line intersects the Hose ID scale at 25 mm. Therefore, a hose with a 1" (DN 25 -16) internal diameter is recommended for the application.

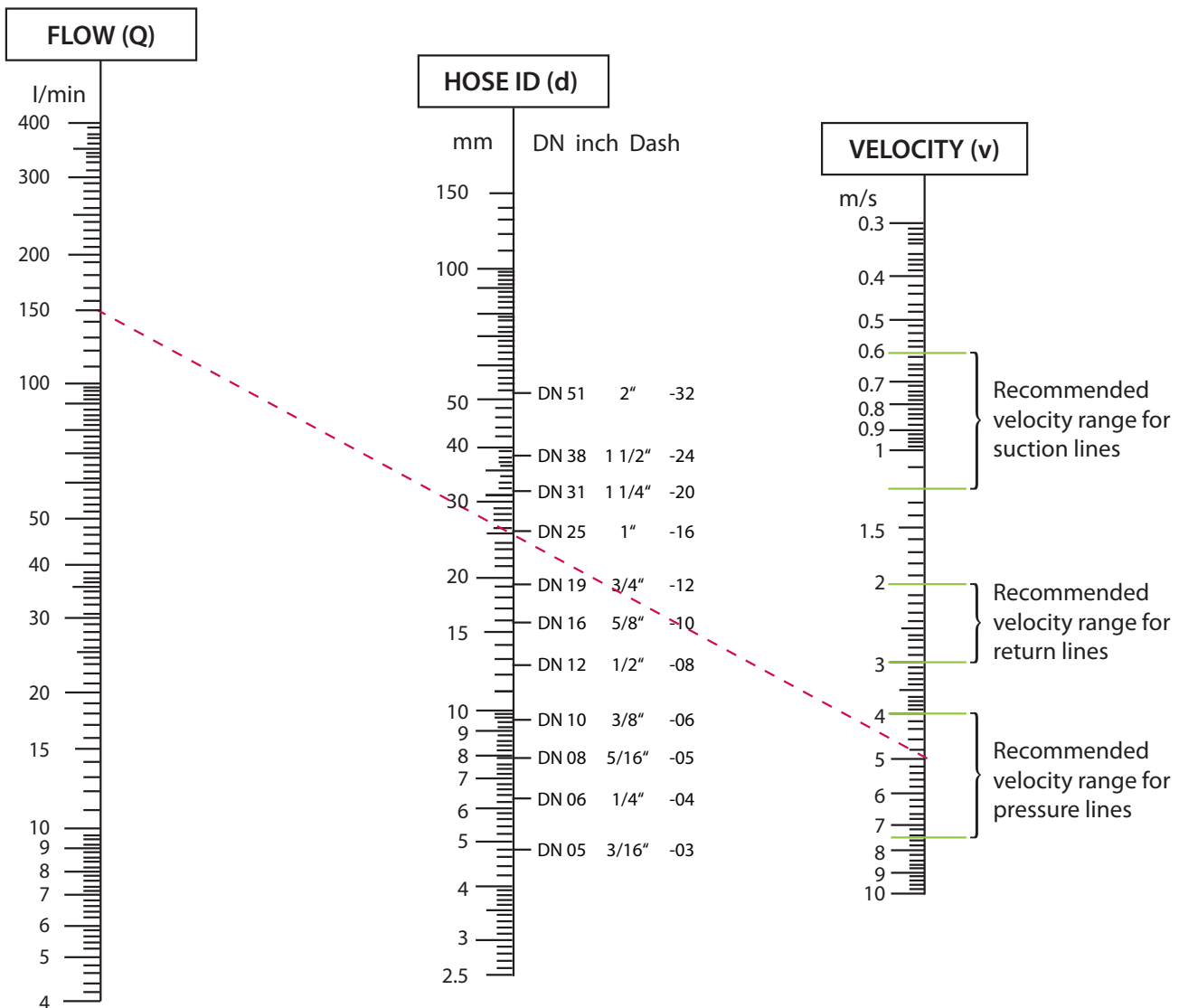

CORRECT ASSEMBLY INSTALLATION

Satisfactory performance and appearance depend upon proper hose installation. Excessive length destroys the trim appearance of an installation and adds unnecessarily to the cost of the equipment. Hose assemblies of insufficient length to permit adequate flexing, expansion or contraction will cause poor power transmission and shorten the life of the hose. The diagrams below offer suggestions for proper hose installations to obtain the maximum in performance and economy.

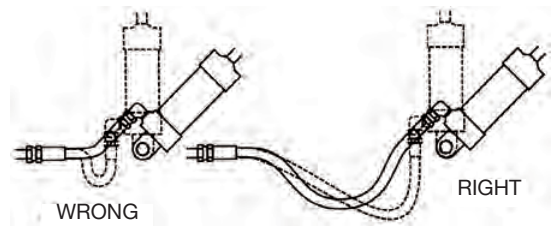

Adequate hose length is most important to distribute movement on flexing applications and to avoid abrasion.

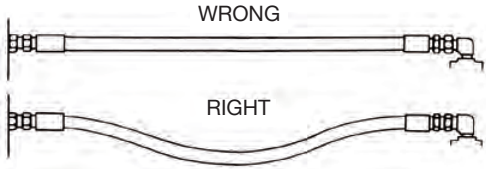

Since hose may change in length from +2% to -4% under the surge of high pressure, provide sufficient slack for expansion and contraction.

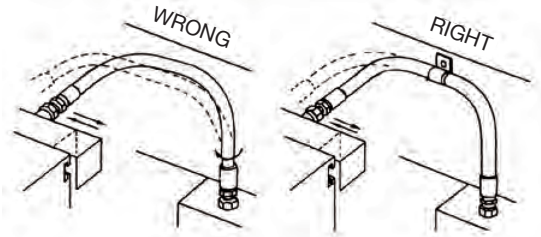

To avoid twisting in hose lines bent in two planes, clamp hose at change of plane, as shown.

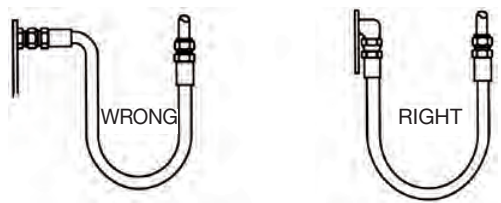

Avoid sharp twist or bend in hose by using proper angle adapters.

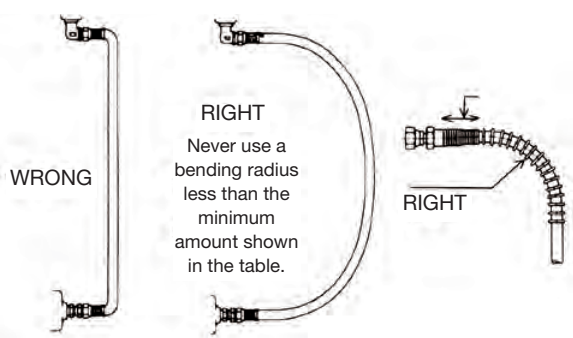

To prevent twisting and distortion, hose should be bent in the same plane as the motion of the boss to which the hose is connected.

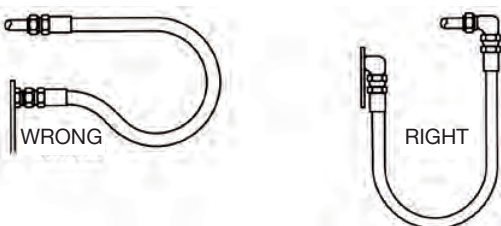

Where the radius falls below the required minimum, an angle adapter should be used as shown above to avoid sharp bends in hose.

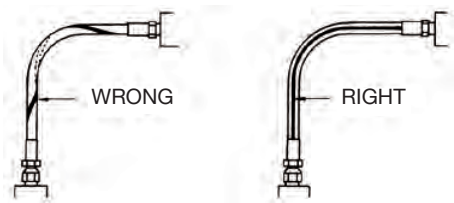

Hose should not be twisted. Hose is weakened when installed in twisted position. Also pressure in twisted hose tends to loosen fitting connections. Design so that machine motion produces bending rather than twisting.

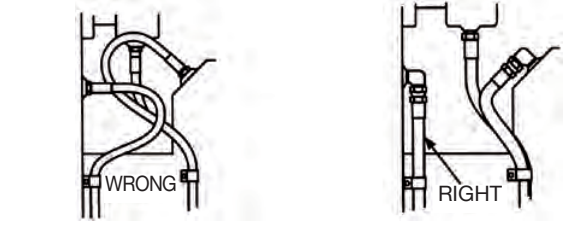

Obtain direct routing of hose through use of 45° and 90° adapters and fittings. Improve appearance by avoiding excessive hose length.

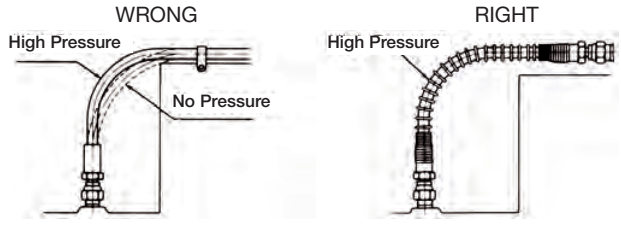

Due to changes in length when hose is pressurised, do not clamp at bends so curves absorb changes and protect the hose with a spring guard. Do not clamp high and low pressure lines together and protect the hose with a spring guard.

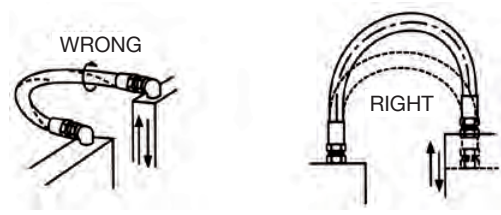

Never use a bending radius less than the minimum shown in the hose specification tables. Avoid sharp bend in hose to reduce collapsing of line and restriction of flow by using proper spring guard. Exceeding minimum bend radius will greatly reduce hose assembly life.

HOW TO DETERMINE CORRECT ASSEMBLY LENGTH

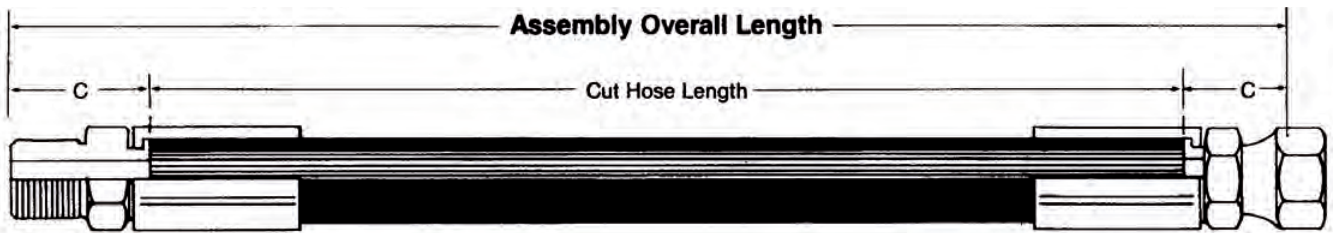

For most assemblies, the correct assembly length may be determined by direct measurement of the equipment or a drawing. Minimum bend radii as shown in the hose specification tables should be observed. Assemblies are measured to the end of the seal.

To determine the length of hose needed in making assemblies with permanent or reusable couplings, subtract Dimension "C" (Cut off factor) for each coupling from the required overall assembly length. Dimension "C" may be found in the coupling specification tables.

HOW TO MEASURE ASSEMBLIES

Length over nipples

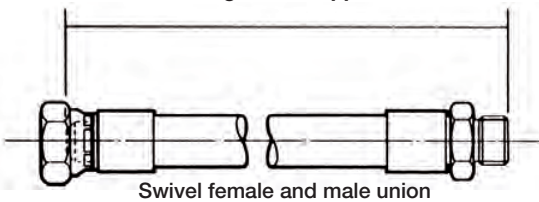

Length between S.P. and nipple ends

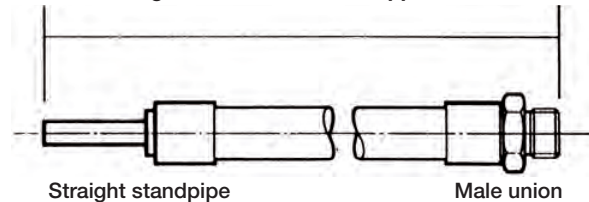

Length between centre lines of angle and banjo

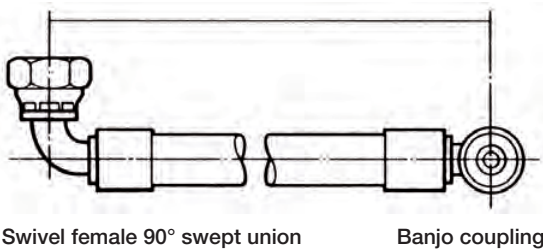

Length between male nipple and centre of female nipple

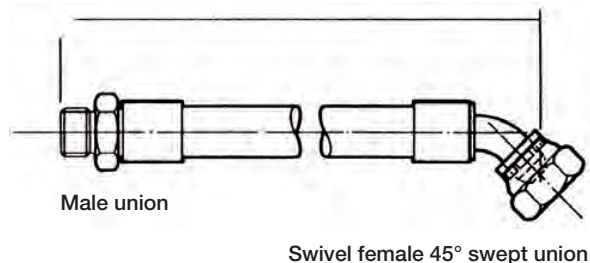

Length between centre lines of S.P. and end of nipple

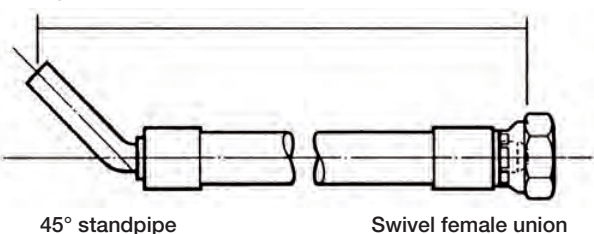

Length between centre of angle and nipple end

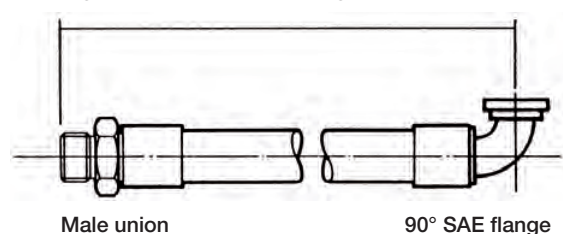

Remember that hydraulic hose under pressure will elongate up to 2% of its length or contract up to 4% depending on pressure, type and size. Sufficient allowance should be made to permit such changes in length.

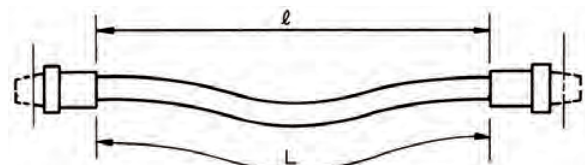

$$L \geq l (1 + 0,04)$$

HOSE GUIDELINE



Occasionally an assembly will be required similar to the sketches to the right. The following equations are helpful in determining the correct length:

FOR 180° TURN APPLICATIONS

#1 $L = 2A + \pi R$

#2 $L = 2A + \pi R + T$

where:

L= overall length of the hydraulic hose assembly, in mm or inches.

A= allowance for a minimum straight section of hydraulic hose at each end of the assembly, measured from the outer end of each coupling, in mm or inches. These two straight sections are necessary to prevent excessive stress concentrations directly back of the couplings. See table below.

R= bending radius of the hose, in mm or inches. See hose specifications tables.

T= amount of travel, in mm or inches.

Often right angle adapters provide a convenient means of avoiding too small a bend radius.

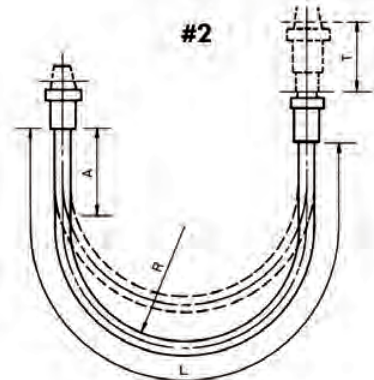
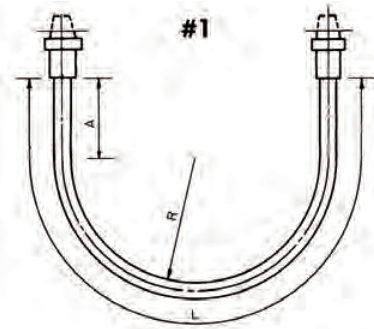

Hose ID	in	1/4	5/16	3/8	1/2	5/8	3/4	1	1 1/4	1 1/2	2
	mm	6,4	7,9	9,5	12,7	15,9	19	25	31,8	38,1	50,8
Min "A"	in	5	5	5	6	6	7	8	9	10	11
	mm	127	127	127	152	152	178	203	229	254	279

Length Tolerance for Hydraulic Hose Assemblies and Specified Hose Lengths

Length	Tolerance
For length > 0 and <= 12" (305 mm)	± 1/8" ± 3 mm
For length > 12" (305 mm) and <= 18" (457 mm)	± 3/16" ± 5 mm
For length > 18" (457 mm) and <= 36" (914 mm)	± 1/4" ± 6 mm
For length > 36" (914 mm) and <= 48" (1219 mm)	± 3/8" ± 10 mm
For length > 48" (1219 mm) and <= 72" (1830 mm)	± 1/2" ± 13 mm
For length > 72" (1830 mm)	± 1%

Elbow angle and angle of Orientation Tolerance ±3

Angle Couplings

To measure angle of offset of a hose assembly, point one end of coupling "A" (the nearest) to a vertical position downward. The angle can then be measured from the centreline of this vertical coupling in an anticlockwise direction to the centreline of coupling "B" (the far coupling) (see illustration). Relationships can then be expressed from 0° to 360°. If angle not given elbows are positioned at 0°.

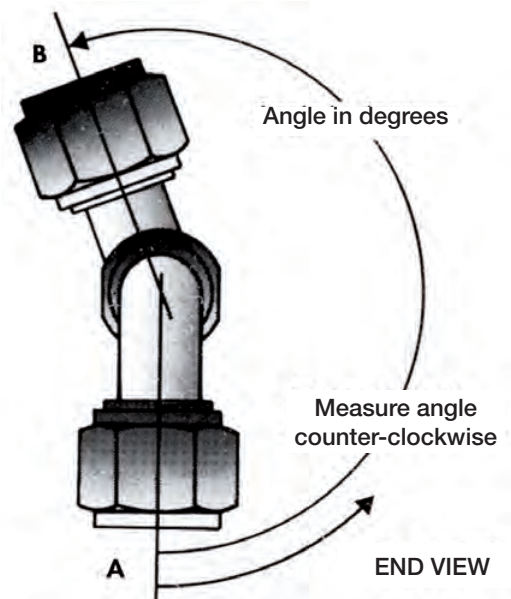

FITTING IDENTIFICATION

DASH NUMBERS

Most fluid piping system sizes are measured by dash numbers. These are universally used abbreviations for the size of component expressed as the numerator of the fraction with the denominator always being 16. For example, a -04 port is 4/16 or 1/4 inch. Dash numbers are usually nominal (in name only) and are abbreviations

that make ordering of components easier. There are many coupling systems used for hydraulic connections. They are identified as:

American, British, French, German, Japanese

This section lists the origin and coupling style.

Descriptions and dimensional data follows each coupling style.

AMERICAN THREAD TYPES

NPTF - (National Pipe Tapered Fuel)

This is a dryseal thread, the National pipe tapered thread for fuels. This is used for both male and female ends. This connection is still widely used in fluid power systems, even through it is not recommended by the National Fluid Power Association (N.F.P.A.) for use in hydraulic applications.

The NPTF male will mate with the NPTF, NPSF or NPSM female.

The NPTF male has tapered threads and a 30° inverted seat. The NPTF female has tapered threads and no seat. The seal takes place by deformation of the threads. The NPSM female has straight threads and a 30° inverted seat. The seal takes place on the 30° seat.

The NPTF connector is similar to, but not interchangeable with, the BSPT connector. The thread pitch is different in most sizes. Also, the thread angle is 60° instead of the 55° angle found on BSPT threads.

NPSF - (National Pipe Straight Thread for Fuels)

The National pipe straight thread for fuels. This is sometimes used for female ends and properly mates with the NPTF male end. However, the SAE recommends the NPTF thread in preference to the NPSF for female ends.

NPSM - (National Pipe Straight Mechanical)

National pipe straight thread for mechanical joint. This is used on the female swivel nut of iron pipe swivel adapters. The leak-resistant joint is not made by the sealing fit of threads, but by a tapered seat in the coupling end. This connection is sometimes used in fluid power systems.

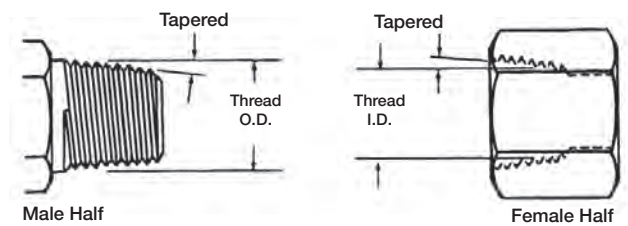

Thread Identification Table

National Pipe Straight Mechanical (NPSM)

National Pipe Tapered for Fuels (NPTF)

Tube Size Dash	Tube Size	Thread Size in-TPI	Female Thread I.D.		Male Thread O.D.	
			mm	in	mm	in
-02	1/8	1/8-27	8.7	0.34	10.3	0.41
-04	1/4	1/4-18	11.9	0.47	14.3	0.56
-06	3/8	3/8-18	15.1	0.59	17.5	0.69
-08	1/2	1/2-14	18.3	0.72	21.4	0.84
-12	3/4	3/4-14	23.8	0.94	27.0	1.06
-16	1	1-11.5	30.2	1.19	33.3	1.31
-20	1 1/4	1.1/4-11.5	38.9	1.53	42.9	1.69
-24	1 1/2	1.1/2-11.5	44.5	1.75	48.4	1.91
-32	2	2-11.5	57.2	2.25	60.3	2.38

SAE J514 Straight Thread O-Ring Boss (ORB)

This port connection is recommended by the N.F.P.A. for optional leakage control in medium and high pressure hydraulic systems. The O’ring boss male will mate with an O’ring boss female only. The female is generally found on ports.

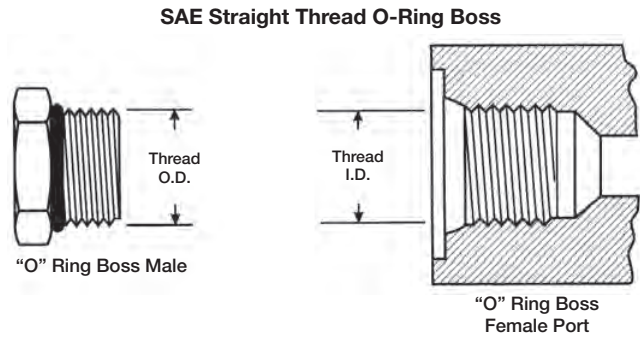

**Thread Identification Table
SAE J514 Straight Thread O-Ring Boss**

Dash Size	Inch Size in	Thread Size in-TPI	Female Thread I.D.		Male Thread O.D.	
			mm	in	mm	in
-02	1/8	5/16-24	6.9	0.27	7.8	0.31
-03	3/16	3/8-24	8.5	0.34	9.4	0.37
-04	1/4	7/16-20	9.9	0.39	11.2	0.44
-05	5/16	1/2-20	11.5	0.45	12.6	0.49
-06	3/8	9/16-18	12.9	0.51	14.1	0.56
-08	1/2	3/4-16	17.5	0.69	18.9	0.74
-10	5/8	7/8-14	20.5	0.81	22.1	0.87
-12	3/4	1.1/16-12	24.9	0.98	26.9	1.06
-14	7/8	1.3/16-12	28.1	1.11	30.3	1.18
-16	1	1.5/16-12	31.3	1.23	33.1	1.31
-20	1 1/4	1.5/8-12	39.2	1.54	41.1	1.62
-24	1 1/2	1.7/8-12	45.6	1.79	47.4	1.87
-32	2	2.1/2-12	61.4	2.42	63.3	2.49

The male has straight threads and an O’ring. The female has straight threads and a sealing face. The seal is made at the O’ring on the male and the sealing face on the female. The threads hold the connection mechanically.

SAE J514 37° (JIC)

The Society of Automotive Engineers (SAE) specifies a 37° angle flare or seat be used with high pressure hydraulic tubing. These are commonly called JIC couplings. The JIC 37° flare male will mate with a JIC female only. The JIC male has straight threads and a 37° flare seat. The JIC female has straight threads and a 37° flare seat. The seal is made on the 37° flare seat by establishing a line contact between the male flare and the female cone seat. The threads hold the connection mechanically.

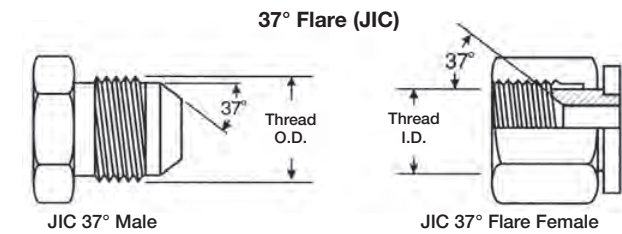

**Thread Identification Table
SAE J514 37° Flare (JIC)**

Tube Size Dash	Tube Size Inch	Thread Size in-TPI	Female Thread I.D.		Male Thread O.D.	
			mm	in	mm	in
-02	1/8	5/16-24	6.9	0.27	7.8	0.31
-03	3/16	3/8-24	8.5	0.34	9.4	0.37
-04	1/4	7/16-20	9.9	0.39	11.2	0.44
-05	5/16	1/2-20	11.5	0.45	12.6	0.49
-06	3/8	9/16-18	12.9	0.51	14.1	0.56
-08	1/2	3/4-16	17.5	0.69	18.9	0.74
-10	5/8	7/8-14	20.5	0.81	22.1	0.87
-12	3/4	1.1/16-12	24.9	0.98	26.9	1.06
-14	7/8	1.3/16-12	28.1	1.11	30.3	1.18
-16	1	1.5/16-12	31.3	1.23	33.1	1.31
-20	1 1/4	1.5/8-12	39.2	1.54	41.1	1.62
-24	1 1/2	1.7/8-12	45.6	1.79	47.4	1.87
-32	2	2.1/2-12	61.4	2.42	63.3	2.49

CAUTION: In the -02, -03, -04, -05, -08 and -10 sizes, the threads of the SAE 45° flare and the SAE 37° flare are the same. However, the sealing surface angles are not the same. Carefully measure the seat angle to differentiate.

SAE J512 45°

A term usually applied to fittings having a 45° angle flare or seat. Soft copper tubing is generally used in such applications as it is easily flared to the 45° angle. These are for low pressure applications-commonly used in refrigeration, automotive and truck piping systems. The SAE 45° flare male will mate with an SAE 45° flare female only. The SAE male has straight threads and a 45° flare seat. The SAE female has straight threads and a 45° flare seat. The seal is made on the 45° flare seat.

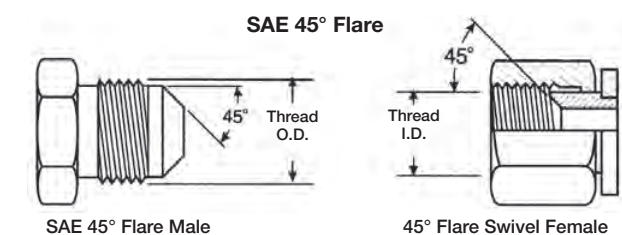

**Thread Identification Table
SAE J512 45°**

Tube Size Dash	Tube Size Inch	Thread Size in-TPI	Female Thread I.D.		Male Thread O.D.	
			mm	in	mm	in
-02	1/8	5/16-24	6.9	0.27	7.9	0.31
-03	3/16	3/8-24	8.6	0.34	9.6	0.38
-04	1/4	7/16-20	9.9	0.39	11.2	0.44
-05	5/16	1/2-20	11.4	0.45	12.7	0.50
-06	3/8	5/8-18	14.2	0.56	15.7	0.62
-07	7/16	11/16-16	15.7	0.62	17.3	0.68
-08	1/2	3/4-16	17.0	0.68	19.0	0.75
-10	5/8	7/8-14	20.3	0.80	22.3	0.88
-12	3/4	1.1/16-14	25.1	0.99	26.9	1.06
-14	7/8	1.1/4-12	29.5	1.16	31.7	1.25
-16	1	1.3/8-12	32.5	1.28	35.0	1.38

The threads hold the connection mechanically. CAUTION: In the -02, -03, -04, -05, -08 and -10 sizes, the threads of the SAE 45° flare and the SAE 37° flare are the same. However, the sealing surface angles are not the same. Carefully measure the seat angle to differentiate.

SAE J1453 O-Ring Face Seal (ORFS)

A seal is made when the O-ring in the male contacts the flat face on the female. Couplings are intended for hydraulic systems where elastomeric seals are acceptable to overcome leakage and leak resistance is crucial. This connection offers the very best leakage control available today.

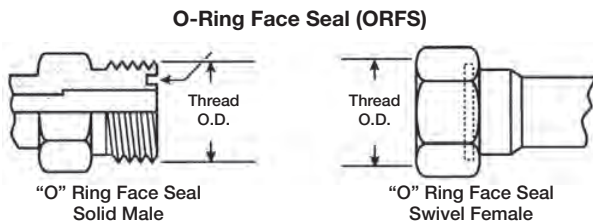

Thread Identification Table SAE J1453 O-Ring Face Seal (ORFS)

Tube Size Dash	Tube Size Inch	Thread Size in-TPI	Female Thread I.D.		Male Thread O.D.	
			mm	in	mm	in
-04	1/4	9/16-18	12.9	0.51	14.1	0.56
-06	3/8	11/16-16	15.9	0.63	17.3	0.68
-08	1/2	13/16-16	19.1	0.75	20.5	0.81
-10	5/8	1-14	23.6	0.93	25.2	0.99
-12	3/4	1.3/16-12	28.1	1.11	30.0	1.18
-16	1	1.7/16-12	34.4	1.36	36.3	1.43
-20	1 1/4	1.11/16-12	40.8	1.61	42.7	1.68
-24	1 1/2	2-12	48.7	1.92	50.6	1.99

The male connector has a straight thread and a machined flat face. The female has a straight thread and a machined flat face. The seal takes place by compressing the O-Ring onto the flat face of the female, similar to the split flange type fitting. The threads hold the connection mechanically.

SAE J512 Inverted Flare

This connection is frequently used in automotive systems. The male connector can either be a 45° flare in the tube fitting form or a 42° seat in the machined adapter form. The female has a straight thread with a 42° inverted flare. The seal takes place on the flared surface. The threads hold the connection mechanically.

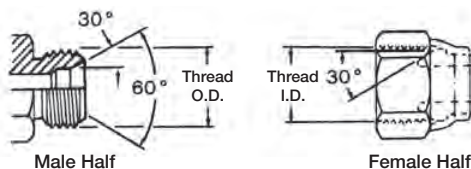

Thread Identification Table SAE J512 Inverted Flare

Tube Size Dash	Tube Size Inch	Thread Size in-TPI	Female Thread I.D.		Male Thread O.D.	
			mm	in	mm	in
-02	1/8	5/16-28	6.9	0.27	7.9	0.31
-03	3/16	3/8-24	8.6	0.34	9.6	0.38
-04	1/4	7/16-24	9.9	0.39	11.2	0.44
-05	5/16	1/2-20	11.4	0.45	12.7	0.50
-06	3/8	5/8-18	14.2	0.56	15.7	0.62
-07	7/16	11/16-18	15.7	0.62	17.3	0.68
-08	1/2	3/4-18	17.0	0.68	19.0	0.75
-10	5/8	7/8-18	20.3	0.80	22.3	0.88
-12	3/4	1.1/16-16	25.1	0.99	26.9	1.06

SAE J1467 Clip Fastener

This is a radial O-Ring seal connection commonly used for hydraulic applications in underground mines. The male contains an exterior O-Ring and backup ring, plus a groove to accept the "staple". The female has a smooth bore with two holes for the staple.

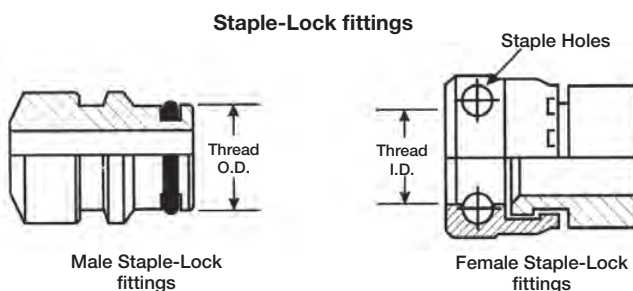

Identification Table SAE J1467 Clip Fastener

Dash Size	Inch Size in	Female Staple-Lock I.D.		Male Staple-Lock O.D.	
		mm	in	mm	in
-04	1/4	14.9	19/32	15.1	19/32
-06	3/8	19.9	51/64	20.1	51/64
-08	1/2	23.9	61/64	24.1	61/64
-12	3/4	28.9	1.9/64	29.1	1.9/64
-16	1	38.9	1.35/64	39.1	1.35/64
-20	1 1/4	45.9	1.13/16	46.1	1.13/16
-24	1 1/2	54.9	1.11/64	55.2	2.11/64
-32	2	63.9	1.17/32	64.2	2.17/32

A "U" shaped retaining clip or staple is inserted through the two holes, passing through the groove in the male to lock the connection together. The seal takes place by contact between the O-Ring in the male and the smooth bore of the female.

SAE J518/ISO-DIS 6162/JIS B8363 O-Ring Flange

This connection is commonly used in fluid power system. There are two pressure ratings. Code 61 Form R, PN 35/350 bar, Type I, is referred to as the “standard” series and Code 62 Form S, PN 415 bar, Type II, is the “heavy duty” “6000 psi” series. The design concept for both series is the same, but the bolt hole spacing and flanged head diameters are larger for the higher pressure, Code 62 connection.

The female (port) is an unthreaded hole with four bolt holes in a rectangular pattern around the port.

The male consists of a flanged head, grooved for an O-Ring, and either a captive flange or split flange halves with bolt holes to match the port. The seal take place on the O-Ring, which is compressed between the flange head and the flat surface surrounding the port. The threaded bolts hold the connection together.

SAE J518, DIN 20066, ISO/DIS 6162 and JIS B 8363 are interchangeable, except for bolt sizes.

*All Code 61 flange head hose couplings meet or exceed SAE J518 Code 61 requirements for hydraulic split flange connections. The Code 61 flange head design can withstand a maximum operating pressure of 3000 to 5000 psi depending on size.

SAE Code 61 and Code 62 flange 4 holes

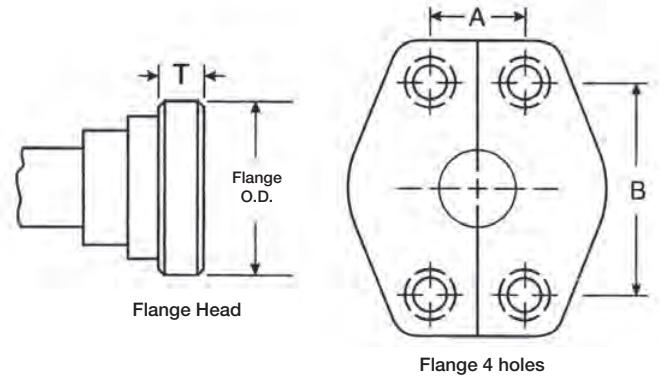

Flange Dash Size	SAE CODE 61 - 3000 psi								SAE CODE 62 - 6000 psi								CATERPILLAR								
	Flange Head Size		Flange Head T		A		B		Flange Head Size		Flange Head T		A		B		Flange Head Size		Flange Head T		A		B		
	in	mm	in	mm	in	mm	in	mm	in	mm	in	mm	in	mm	in	mm	in	mm	in	mm	in	mm	in	mm	
-08	1.19	30.2	.265	6.7	.69	17.5	1.50	38.1	1.25	31.8	.305		.71	18.2	1.59	40.5									
-10*	1.34	34.0	.265	6.7	.78	19.8	1.69	42.9																	
-12	1.50	38.1	.265	6.7	.87	22.2	1.89	47.6	1.63	41.3	.345	8.7	.94	23.8	2.00	50.8	1.63	41.3	.56	14.2	.94	23.8	2.00	50.8	
-16	1.75	44.5	.315	8.0	1.03	26.2	2.05	52.4	1.88	47.6	.375	9.5	1.10	27.8	2.25	57.2	1.88	47.6	.56	14.2	1.10	27.8	2.25	57.2	
-20	2.00	50.8	.315	8.0	1.19	30.2	2.31	58.7	2.13	54.0	.405	10.3	1.26	31.8	2.63	66.7	2.13	54.0	.56	14.2	1.26	31.8	2.63	66.7	
-24	2.38	60.3	.315	8.0	1.41	35.7	2.75	69.9	2.50	63.5	.495	12.6	1.44	36.6	3.13	79.4	2.50	63.5	.56	14.2	1.44	36.6	3.13	79.4	
-32	2.81	71.4	.375	9.5	1.69	42.9	3.06	77.8	3.13	79.4	.495	12.6	1.73	44.4	3.81	96.8	3.13	79.4	.56	14.2	1.73	44.4	3.81	96.8	
-40	3.31	84.1	.375	9.5	2.00	50.8	3.50	88.9																	

T = Thickness
 -10 is a non SAE size flange

How to measure

Four Bolt Flange-First measure the port hole diameter using the caliper. Next, measure the longest bolt hole spacing from centre-to-centre (Dimension “A”) or measure the flanged head diameter. O.D.

There are three exceptions:

1. The size -10, which is common outside of North America is not an SAE Standard size.
2. Caterpillar flanges, which are the same flange O.D. as SAE Code 62, have a thicker flange head.
3. Poclairn flanges, which are completely different from SAE flanges.

BRITISH CONNECTIONS

British Standard Pipe Parallel (BSPP)

Popular couplings British Standard Pipe (BSP) threads, also known as Whitworth threads.

The BSPP (parallel) male will mate with a BSPP (parallel) female or a female port.

The BSPP male has straight threads and a 30° seat.

The BSPP female has straight threads and a 30° seat.

The female port has straight threads and a spotface.

The seal on the port is made with an O-Ring or soft metal washer on the male. The BSPP (parallel) connector is similar to, but not interchangeable with, the NPSM connector. The thread pitch is different in most sizes, and the thread angle is 55° instead of the 60° angle found on NPSM threads. The female swivel BSPP has a tapered nose which seals on the cone seat of the male.

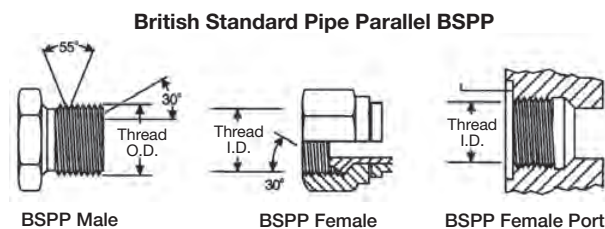

British Standard Pipe Tapered (BSPT)

The BSPT (tapered) male will mate with a BSPT (tapered) female, or a BSPP (parallel) female. The BSPT male has tapered threads. When mating with either the BSPT (tapered) female or the BSPP (parallel) female port, the seal is made on the threads accomplished by thread distortion. A thread sealant is recommended.

The BSPT connector is similar to, but not interchangeable with, the NPTF connector. The thread pitch is different in most cases, and the thread angle is 55° instead of the 60° angle found on NPTF threads.

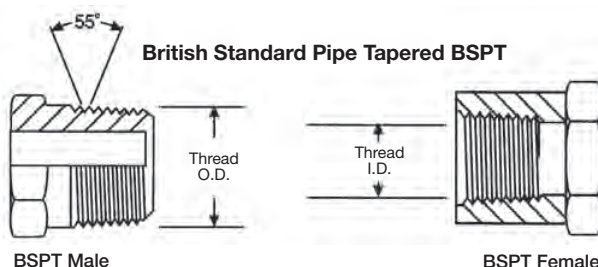

Thread Identification Table

BSPP-(British Standard Pipe Parallel)

BSPT-(British Standard Pipe Tapered)

Dash Size	Inch Size in	Thread Size in-TPI	Female Thread I.D.		Male Thread O.D.	
			mm	in	mm	in
-02	1/8	1/8-27	8.7	0.34	9.5	0.38
-04	1/4	1/4-18	11.1	0.44	13.5	0.56
-06	3/8	3/8-18	15.1	0.59	16.7	0.66
-08	1/2	1/2-14	18.3	0.72	20.6	0.81
-10	5/8	5/8-14	20.6	0.81	23.0	0.91
-12	3/4	3/4-14	23.8	0.94	26.2	1.03
-16	1	1-11	30.2	1.19	33.3	1.31
-20	1 1/4	1.1/4-11	38.9	1.53	41.1	1.66
-24	1 1/2	1.1/2-11	45.2	1.78	47.6	1.88
-32	2	2-11	56.4	2.22	59.5	2.34

FRENCH CONNECTIONS

French GAZ have a 24° seat and metric threads. These are similar to German DIN couplings, but the threads are different in some sizes, the French use fine threads in all sizes. French flanges are different than SAE, they have a lip that protrudes from the flange face. These are Poclairn style flanges.

Millimetrique and GAZ 24°

This connection consists of a common male and two different females. The French Metric (GAZ) male will mate with the female 24° cone or the female tube fitting. The male has a 24° seat and straight metric threads. The female has a 24° seat or a tubing sleeve and straight metric threads. The Millimetrique Series is used with whole number metric O.D. tubing and the GAZ Series is used with fractional number metric O.D. pipe size tubing.

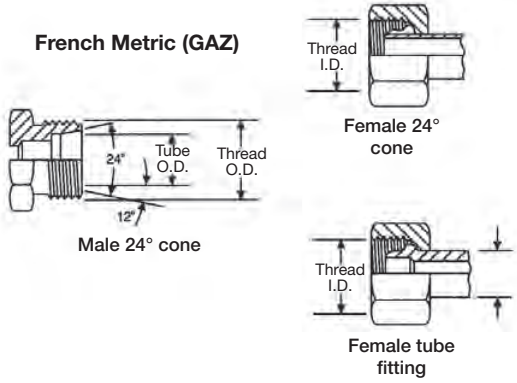

**Thread Identification Table
French Metric Millimetrique**

Metric Thread (dia x pitch)	Female Thread I.D.		Male Thread O.D.		Tube O.D.	
	mm	in	mm	in	mm	in
M12 X 1.0	11.0	0.43	12.0	0.47	6	0.24
M14 X 1.5	12.5	0.49	14.0	0.55	8	0.31
M16 X 1.5	14.5	0.57	16.0	0.63	10	0.39
M18 X 1.5	16.5	0.65	18.0	0.71	12	0.47
M20 X 1.5	18.5	0.73	20.0	0.79	14	0.55
M22 X 1.5	20.5	0.81	22.0	0.87	15	0.59
M24 X 1.5	22.5	0.89	24.0	0.94	16	0.63
M27 X 1.5	25.5	1.00	27.0	1.06	18	0.71
M30 X 1.5	28.5	1.12	30.0	1.18	22	0.87
M33 X 1.5	31.5	1.24	33.0	1.30	25	0.98
M36 X 1.5	34.5	1.36	36.0	1.42	28	1.10
M39 X 1.5	37.5	1.48	39.0	1.54	30	1.18
M42 X 1.5	40.5	1.59	42.0	1.65	32	1.26
M45 X 1.5	43.5	1.71	45.0	1.77	35	1.38
M48 X 1.5	46.5	1.83	48.0	1.89	38	1.50
M52 X 1.5	50.5	1.99	52.0	2.05	40	1.57
M54 X 2.0	51.9	2.04	54.0	2.13	45	1.77

**Thread Identification Table
French Metric GAZ 24° Cone**

Dash Size (dash)	Metric Thread (dia x pitch)	Female Thread I.D.		Male Thread O.D.		Tube O.D.	
		mm	in	mm	in	mm	in
-06	M20 X 1.5	18.5	0.73	20.0	0.78	13.25	0.52
-08	M24 X 1.5	22.5	0.89	24.0	0.94	16.75	0.66
-10	M30 X 1.5	28.5	1.12	30.0	1.18	21.25	0.83
-12	M36 X 1.5	34.5	1.36	36.0	1.41	26.75	1.05
-16	M45 X 1.5	43.5	1.71	45.0	1.77	33.50	1.32
-20	M52 X 1.5	50.5	1.99	52.0	2.04	42.25	1.66

GAZ Poclairn 24° Flange

The Poclairn (French GAZ) 24° high pressure flange is usually found on Poclairn equipment. The male flange will mate with a female flange or a port. The seal is made on the 24° seat.

Nominal Size in	A		B		E	
	mm	in	mm	in	mm	in
1/2	39.9	1.57	18.3	.72	14	.55
5/8	39.9	1.57	18.3	.72	14	.55
3/4	50.8	2	23.9	.94	18	.71

GERMAN DIN CONNECTIONS

A coupling referred to as metric, usually means a DIN coupling. Flanges are standard Code 61 or Code 62.

DIN 2353 24° Cone

The DIN 24° cone male will mate with any of the three females shown below.

The male has a 24° seat, straight metric threads, and a recessed counterbore which matches the tube O.D. used with it. The mating female may be a 24° cone with O'ring, (DKO type) a metric tube fitting or a universal 24° or 60° cone.

DIN 24° Male and Mating Females

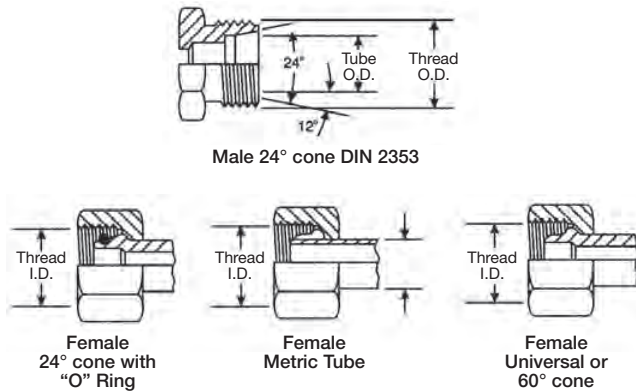

Thread Identification Table DIN 24° Cone

Metric Thread (dia x pitch)	Female Thread I.D.		Male Thread O.D.		Tube O.D.			
	mm	in	mm	in	Light Series		Heavy Series	
	mm	in	mm	in	mm	in	mm	in
M12 X 1.5	10.5	0.41	12	0.47	6	0.24		
M14 X 1.5	12.5	0.49	14	0.55	8	0.31	6	0.24
M16 X 1.5	14.5	0.57	16	0.63	10	0.39	8	0.31
M18 X 1.5	16.5	0.65	18	0.71	12	0.47	10	0.39
M20 X 1.5	18.5	0.73	20	0.79			12	0.47
M22 X 1.5	20.5	0.81	22	0.87	15	0.59	14	0.55
M24 X 1.5	22.5	0.89	24	0.94			16	0.63
M26 X 1.5	24.5	0.96	26	1.02	18	0.71		
M30 X 2.0	27.9	1.10	30	1.18	22	0.87	20	0.79
M36 X 2.0	33.9	1.33	36	1.42	28	1.10	25	0.98
M42 X 2.0	39.9	1.57	42	1.65			30	1.18
M45 X 2.0	42.9	1.69	45	1.77	35	1.38		
M52 X 2.0	49.9	1.96	52	2.05	42	1.65	38	1.50

There is a light and heavy series DIN coupling. Proper identification is made by measuring both the thread size and the tube O.D. (The heavy series has a smaller tube O.D. than the light, but has a thicker wall section).

DIN 3863 60° Cone

This connection is frequently used in hydraulic systems. The DIN 60° cone male will mate with the female universal 24° or 60° cone only.

The male has a 60° seat and straight metric threads. The female has a 24° and 60° universal seat and straight metric threads. The seal takes place by contact between the cone of the male and the nose of the flareless swivel. The threads hold the connection mechanically.

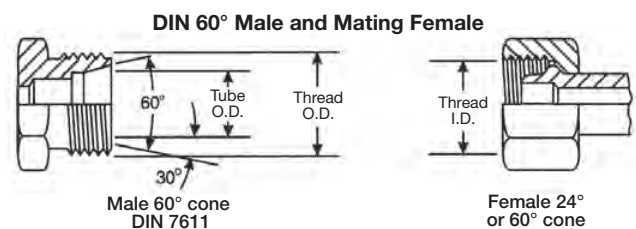

Thread Identification Table DIN 60°

Metric Thread (dia x pitch)	Female Thread I.D.		Male Thread O.D.		Tube O.D.	
	mm	in	mm	in	mm	in
M12 X 1.5	10.5	0.41	12	0.47	6	0.24
M14 X 1.5	12.5	0.49	14	0.55	8	0.31
M16 X 1.5	14.5	0.57	16	0.63	10	0.39
M18 X 1.5	16.5	0.65	18	0.71	12	0.47
M22 X 1.5	20.5	0.81	22	0.87	15	0.59
M26 X 1.5	24.5	0.96	26	1.02	18	0.71
M30 X 1.5	28.5	1.12	30	1.18	22	0.87
M38 X 1.5	36.5	1.44	38	1.50	28	1.10
M45 X 1.5	43.5	1.71	45	1.77	35	1.38
M52 X 1.5	50.5	1.99	52	2.05	42	1.65

Metric Standpipe

A metric standpipe is comprised of three components attached to a male fitting. The components are a Standpipe, Bite Sleeve and Metric Nut. The nut is placed over the Standpipe, followed by the Bite Sleeve (see illustration below). For DIN light assemblies, a DIN light metric nut is used. For DIN heavy assemblies, a DIN heavy metric nut is used. Bite Sleeve and Standpipe are selected on the basis of tube O.D.

Metric Standpipe Assembly

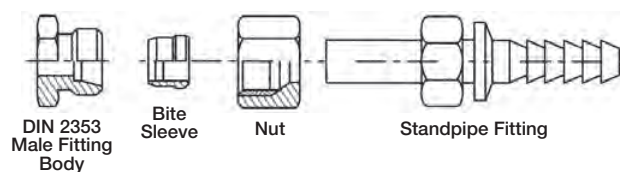

Tube O.D. mm	Metric Nut Thread	
	Light	Heavy
6	M12 X 1.5	
8	M14 X 1.5	M16 X 1.5
10	M16 X 1.5	M18 X 1.5
12	M18 X 1.5	M20 X 1.5
15	M22 X 1.5	
16		M24 X 1.5
18	M26 X 1.5	
20		M30 X 2.0
22	M30 X 1.5	
25		M36 X 2.0
28	M36 X 2.0	
30		M42 X 2.0
35	M45 X 2.0	
38		M52 X 2.0
42	M52 X 2.0	

JAPANESE CONNECTIONS

Japanese equipment uses JIS (Japanese Industrial Standard) couplings with a 30° seat and British Standard Pipe Parallel threads. All flanges are Code 61 or Code 62 (except -10).

JIS 30° Flare Parallel Pipe Threads - JIS B 0202

These Japanese 30° flare male coupling will mate with a Japanese 30° flare female only. The male and female have straight threads and a 30° seat. The seal is made on the 30° seat. The threads on the Japanese 30° flare connector conform to JIS B 0202, the same as the BSPP threads. Both the British and Japanese connectors have a 30° seat, but they are not interchangeable, because the British seat is inverted.

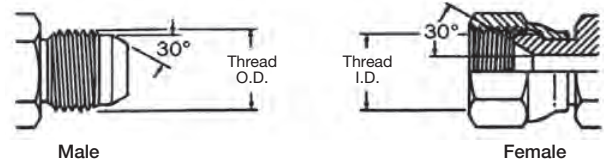

JIS 30° Inverted Seat, Parallel Pipe Threads - JIS B 0202

The JIS parallel is similar to the BSPP connection. The JIS parallel thread and the BSPP connection are interchangeable.

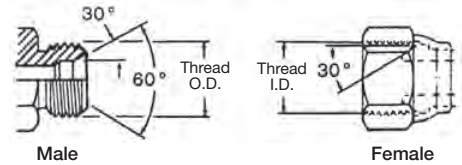

JIS Tapered Pipe Thread (PT) - JIS B 0203

The JIS tapered pipe thread connection is similar to the BSPT connection and fully interchangeable. The Japanese connection does not have a 30° Flare, and will not mate with the BSPP female. The thread conform to JIS B 0203, same as BSPT threads. The seal on the JIS tapered pipe thread connection is made on the threads.

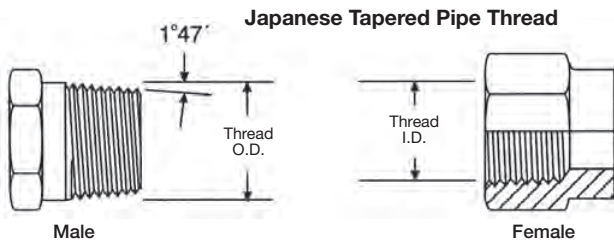

Thread Identification Table

Dash Size	Inch Size	Thread Size in-TPI	Female Thread I.D.		Male Thread O.D.	
			mm	in	mm	in
-02	1/8	1/8-27	8.7	0.34	9.5	0.38
-04	1/4	1/4-18	11.1	0.44	13.5	0.56
-06	3/8	3/8-18	15.1	0.59	16.7	0.66
-08	1/2	1/2-14	18.3	0.72	20.6	0.81
-10	5/8	5/8-14	20.6	0.81	23.0	0.91
-12	3/4	3/4-14	23.8	0.94	26.2	1.03
-16	1	1-11	30.2	1.19	33.3	1.31
-20	1 1/4	1.1/4-11	38.9	1.53	41.1	1.66
-24	1 1/2	1.1/2-11	45.2	1.78	47.6	1.88
-32	2	2-11	56.4	2.22	59.5	2.34

Komatsu Style 30° Flare Parallel Threads

The Komatsu style 30° Flare Parallel thread coupling is identical to the Japanese 30° Flare parallel except for the threads. The Komatsu uses Metric fine threads which conform to JIS B 0207. The Komatsu connector seals on the 30° Flare.

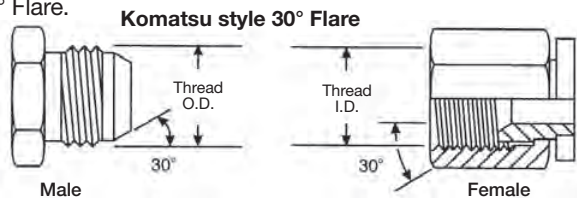

Dash Size	Inch Size	Metric Thread Size	Male Thread O.D. mm	B Thread I.D. mm
-06	3/8	M18 X 1.5	18	16.4
-08	1/2	M22 X 1.5	22	20.4
-10	5/8	M24 X 1.5	24	22.4
-12	3/4	M30 X 1.5	30	28.4
-16	1	M33 X 1.5	33	31.4
-20	1.1/4	M36 X 1.5	36	34.4
-24	1.1/2	M42 X 1.5	42	40.4

Komatsu Flange Fitting

The Komatsu Flange fitting is nearly identical to and fully interchangeable with the SAE Code 61 flange fitting. In all sizes the O-ring dimensions are different. When replacing a Komatsu flange with an SAE style flange, an SAE style O-ring must be used.

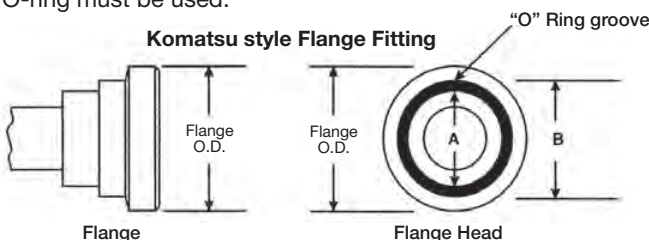

Flange Dash Size	Flange Size in	A in	B in
-08	1.19	.73	.98
-10*	1.34	.73	1.10
-12	1.50	.85	1.22
-16	1.75	1.12	1.50
-20	2.00	1.36	1.73
-24	2.38	1.75	2.12
-32	2.81	2.22	2.56

*is a non SAE size flange

RECOMMENDED FITTING AND ADAPTER INSTALLATION TORQUE
SAE J514 37° CONE (JIC)

Dash	Thread	Lb.ft		N.m	
		Min	Max	Min	Max
-04	7/16-20	11	12	15	16
-05	1/2-20	14	15	19	21
-06	9/16-18	18	20	24	28
-08	3/4-16	36	39	49	53
-10	7/8-14	57	63	77	85
-12	1.1/16-12	79	88	107	119
-14	1.3/16-12	94	103	127	140
-16	1.5/16-12	108	113	147	154
-20	1.5/8-12	127	133	172	181
-24	1.7/8-12	158	167	215	226
-32	2.1/2-12	245	258	332	350

BSPP without O-Ring

Dash	Thread	Lb.ft	N.m
-02	1/8-28	7	10
-04	1/4-19	15	20
-06	3/8-19	26	35
-08	1/2-14	44	60
-10	5/8-14	52	70
-12	3/4-14	85	115
-16	1-11	103	140
-20	1.1/4-11	155	210
-24	1.1/2-11	214	290
-32	2-11	295	400

SAE J1453 O-Ring Face Seal (ORFS)

Dash	Thread	Lb.ft		N.m	
		Min	Max	Min	Max
-04	9/16-18	10	12	14	16
-06	11/16-16	18	20	24	27
-08	13/16-16	32	35	43	47
-10	1-14	46	50	60	68
-12	1.3/16-12	65	70	90	95
-16	1.7/16-12	92	100	125	135
-20	1.11/16-12	125	140	170	190
-24	2-12	150	165	200	225

BSPP with O-Ring

Dash	Thread	Lb.ft	N.m
-02	1/8-28	N/A	N/A
-04	1/4-19	15	20
-06	3/8-19	26	35
-08	1/2-14	37	50
-10	5/8-14	44	60
-12	3/4-14	63	85
-16	1-11	85	115
-20	1.1/4-11	140	190
-24	1.1/2-11	177	240
-32	2-11	221	300

SAE Flange J518 Code 61

Dash	Flange size	Lb.ft		N.m	
		Min	Max	Min	Max
-08	1/2	15	19	20	25
-12	3/4	21	29	28	40
-16	1	27	35	37	48
-20	1.1/4	35	46	48	62
-24	1.1/2	46	58	62	79
-32	2	54	66	73	90
-40	2.1/2	79	91	107	124
-48	3	137	149	186	203

JIS (B8363)

Dash	Thread	Lb.ft	N.m
-04	1/4-19	19	25
-06	3/8-19	25	34
-08	1/2-14	49	64
-10	5/8-14	100	132
-12	3/4-14	100	132
-16	1-11	149	196
-20	1.1/4-11	171	225
-24	1.1/2-11	194	255
-32	2-11	240	316

SAE Flange J518 Code 62

Dash	Flange size	Lb.ft		N.m	
		Min	Max	Min	Max
-08	1/2	15	19	20	25
-12	3/4	21	29	28	40
-16	1	27	35	37	48
-20	1 1/4	35	46	48	62
-24	1 1/2	46	58	62	79
-32	2	54	66	73	90

Metric

Thread	Lb.ft		N.m	
	Min	Max	Min	Max
M12 X 1.5	8	11	15	20
M14 X 1.5	13	18	25	30
M16 X 1.5	19	26	35	40
M18 X 1.5	22	30	40	45
M20 X 1.5	24	33	45	50
M22 X 1.5	32	44	60	70
M24 X 1.5	41	55	75	85
M26 X 1.5	46	63	85	95
M30 X 2	57	77	105	120
M36 X 2	74	100	135	150
M42 X 2	111	151	205	230
M45 X 2	136	184	250	280
M52 X 2	147	199	270	300

JIC FFFT TORQUE METHOD

The FFFT (Flats From Finger Tight) method allows to assemble fittings and adapters at the correct torque value without a dynamometric wrench. The rotation applied according the value shown in tab.1 ensure a good sealing, avoid unscrewing and over torque that can cause nut or cone crack.

Assembling instruction:

- hand tighten the joint
- make a longitudinal mark on one of the flats of hex and continue it on the body hex as shown in Fig.1
- tighten the joint further by the number of flat as shown in Tab.1

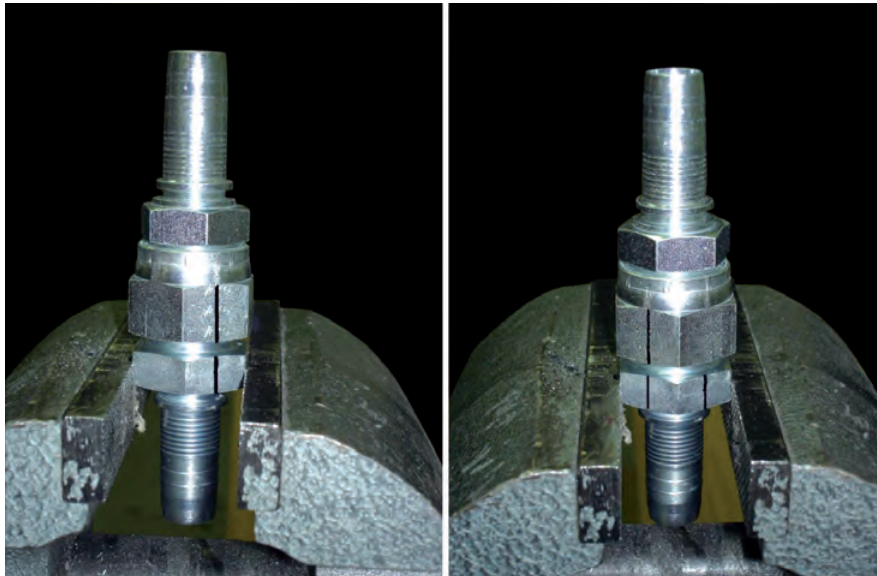

Fig.1

Assembling value - Carbon steel material - SAE J514 JIC 37° flare						
Dash	Thread	Lb.ft		N.m		FFFT 0/+0.25
		min	min	max	max	
-04	7/16-20	11	12	15	16	2
-05	1/2-20	14	15	19	21	2
-06	9/16-18	18	20	24	28	2
-08	3/4-16	36	39	49	53	1.5
-10	7/8-14	57	63	77	85	1.5
-12	1.1/16-12	79	88	107	119	1
-14	1.3/16-12	94	103	127	140	1
-16	1.5/16-12	108	113	147	154	1
-20	1.5/8-12	127	133	172	181	1
-24	1.7/8-12	158	167	215	226	1
-32	2 1/2-12	245	258	332	350	1

Tab.1

HOW TO DETERMINE THE THREAD TYPE USING CALLIPERS

By measuring with a caliper the outside diameter of the thread of a male or the inside diameter of the thread of a female you will get a measure in mm. By finding this value in mm on the below table, you'll be able to find the relevant thread type.

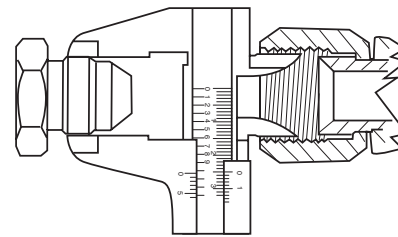

Male OD	mm	Female ID	Male OD	mm	Female ID
1/4" - 18 NPTF	12.5		G1" BSP	33.1	
	12.5	M14 X 1.5	1 5/16" - 12 JIC	33.2	
1/2" - 20 SAE	12.6			34.0	M36 X 2
	12.9	9/16" - 18 JIC		34.5	36 X 1.5 DKF
G1/4" BSP	13.0		M36 X 2	35.8	
M14 X 1.5	13.9		36 X 1.5 CEF	35.9	
9/16" - 18 JIC	14.2			36.5	M36 X 1.5
	14.5	M16 X 1.5	M38 X 1.5	37.9	
	15.1	G3/8" BSP		38.8	1 5/8" 12 JIC
M16 X 1.5	15.8			39.4	G1 1/4" BSP
3/8" - 18 NPTF	15.9			39.8	M42 X 2
	16.5	M18 X 1.5	1 1/4" - 11 1/2 NPTF	40.2	
G3/8" BSP	16.6			40.5	M42 X 1.5
	17.5	3/4" - 16 JIC	1 5/8" 12 JIC	41.1	
M18 X 1.5	17.9		1 1/4" - 11 BSP	41.7	
	18.4	20 X 1.5 DKF	M42 X 2	41.8	
3/4" - 16 JIC	18.8			42.4	M45 X 2
	18.8	G1/2" BSP		43.3	45 X 1.5 DKF
1/2" - 14 NPT	19.8		M45 X 2	44.8	
20 X 1.5 CEF	19.9		45 X 1.5 CEF	44.9	
	20.4	7/8" - 14 SAE		45.1	1 7/8" - 12 JIC
	20.5	M22 X 1.5		45.2	G1 1/2" BSP
G1/2" BSP	20.8		1 1/2" - 11 1/2 NPTF	46.3	
	20.9	G5/8" BSP	1 7/8" - 12 JIC	47.5	
M22 X 1.5	21.9		G1 1/2" BSP	47.7	
7/8" - 14 SAE	22.1			49.6	M52 X 2
	22.5	24 X 1.5 DKF		50.3	52 X 1.5 DKF
G5/8" BSP	22.8		M52 X 2	51.8	
24 X 1.5 CEF	23.9		52 X 1.5 CEF	51.9	
	24.5	G3/4" BSP		57.4	G2" BSP
	24.8	1 1/16" - 12 JIC	2" - 11 1/2 NPTF	58.3	
3/4" - 14 NPTF	25.1		G2" BSP	59.4	
	25.5	M26 X 1.5		61.1	2 1/2" - 12 JIC
M26 X 1.5	25.9			62.5	M65 X 2
G3/4" BSP	26.3		2 1/2" - 12 JIC	63.3	
1 1/16" - 12 JIC	26.8				

PRESSURE CONVERSION TABLES

Metric to psi (1 KPa = .145 psi)

Kilo Pascal (KPa)	Mega Pascal (MPa)	Bar (Bar)	Pounds per Square Inch (psi)
100	0.1	1	14.5
200	0.2	2	29.0
300	0.3	3	43.5
400	0.4	4	58.0
500	0.5	5	72.5
600	0.6	6	87.0
700	0.7	7	101.5
800	0.8	8	116.0
900	0.9	9	130.5
1000	1	10	145.0
2000	2	20	290.1
3000	3	30	435.1
4000	4	40	580.2
5000	5	50	725.5
6000	6	60	870.2
7000	7	70	1015
8000	8	80	1160
9000	9	90	1305
10000	10	100	1450
20000	20	200	2901
30000	30	300	4351
40000	40	400	5802
50000	50	500	7252
60000	60	600	8702
70000	70	700	10153
80000	80	800	11603
90000	90	900	13053
100000	100	1000	14504
200000	200	2000	29008
300000	300	3000	43511

psi to metric (1 psi = 6.89 KPa)

Pounds per Square Inch (psi)	Kilo Pascal (KPa)	Mega Pascal (MPa)	Bar (Bar)
10	68.9	0.07	0.7
20	137.9	0.14	1.4
30	206.8	0.21	2.1
40	275.8	0.28	2.8
50	344.7	0.34	3.4
60	413.7	0.41	4.1
70	482.6	0.48	4.8
80	551.6	0.55	5.5
90	620.5	0.62	6.2
100	689	0.70	6.9
200	1379	1.4	13.8
300	2068	2.1	20.7
400	2758	2.8	27.6
500	3447	3.4	34.5
600	4137	4.1	41.4
700	4826	4.8	48.3
800	5516	5.5	55.2
900	6205	6.2	62.1
1000	6895	6.9	68.9
2000	13790	13.8	147.9
3000	20684	20.7	206.8
4000	27579	27.6	275.8
5000	34474	34.5	344.7
6000	41369	41.4	413.7
7000	48263	48.3	482.6
8000	55158	55.2	551.6
9000	62053	62.1	620.5
10000	68948	68.9	689
20000	137895	147.9	1379
30000	206843	206.8	2068
40000	275790	275.8	2758

CONVERSION TABLES FROM IMPERIAL SYSTEM TO METRIC SYSTEM

Inches	mm
1/64	.0156
1/32	.0312
3/64	.0468
1/16	.0625
5/64	.0781
3/32	.0937
7/64	.1093
1/8	.1250
9/64	.1406
5/32	.1562
11/64	.1718
3/16	.1875
13/64	.2031
7/32	.2187
15/64	.2343
1/4	.2500

Inches	mm
17/64	.2656
9/32	.2812
19/64	.2968
15/16	.3125
21/64	.3281
11/32	.3437
23/64	.3593
3/8	.3750
25/64	.3906
13/32	.4062
27/64	.4218
7/16	.4375
29/64	.4531
15/32	.4687
31/64	.4843
1/2	.5000

Inches	mm
33/64	.5156
17/32	.5312
35/64	.5468
9/16	.5625
37/64	.5781
19/32	.5937
39/64	.6093
5/8	.6250
41/64	.6406
21/32	.6562
43/64	.6718
11/16	.6875
45/64	.7031
23/32	.7187
47/64	.7343
3/4	.7500

Inches	mm
49/64	.7656
25/32	.7812
51/64	.7968
13/16	.8125
53/64	.8281
27/32	.8437
55/64	.8593
7/8	.8750
57/64	.8906
29/32	.9062
59/64	.9218
15/16	.9375
61/64	.9531
31/32	.9687
63/64	.9843
1	1000

ADAPTER SELECTION

Selection of an appropriate ALFAGOMMA adapter for a given application depends on the fluid system operating parameters listed below and the tube material and wall thickness they require:

1. Type of fluid
2. Operating temperature range
3. Type of line-pressure, return or suction
4. Maximum flow rate through the line
5. Maximum operating / service pressure
6. Severity of service
7. Environment

Then, based on the tube selected and appropriate fluid system operating parameters, determine adapter type(s) and material(s) using the features comparison table below.

FEATURES COMPARISON OF TUBE FITTINGS				
Feature		ORFS	JIC 37°	BSP
Performance	Pressure capability*	Very High	Medium to High	Medium to High
	Seal Reliability	Excellent	Good	Very Good
		Elastomeric Seal	Metal to Metal Seal	Elastomeric Seal
		High tolerance to minor surface imperfections and damage. High tolerance to assembly variations.	Low tolerance to minor surface imperfections and damage. Low tolerance to assembly variations.	Low tolerance to minor surface imperfections and damage. Low tolerance to assembly variations.
Vibration Resistance in Rigid Systems	Excellent	Good	Very Good	
Tube Compatibility	Wall Thickness	All	Medium	Medium
	Critical Features	OD tolerance and hardness for flat tube, OD tolerance only for brazed tube	ID finish, wall thickness uniformity (concentricity) and hardness	OD tolerance and hardness
Assembly	Tube Preparation	Easy and quick (slower for sleeve brazing)	Easy and quick	Easy and quick (slower for welded nipple)
	Inspection	Easy and quick	Easy and quick	Critical, need experience
	Ease of Installation	Excellent, Minimum skill and training are necessary because of high tolerances to assembly variations	Good. Low tolerance to assembly variations. Requires skilled and trained personnel	
	Ease of Maintenance	Excellent, no tube entry	Very Good, Small tube entry	Good, Large tube entry
Temperature Capability Adapters without O-Ring	Steel	To be used only with O-ring	-65° F to 500° F	-65° F to 500° F
	Stainless Steel		-425° F to 1200° F	==
	Brass		-40° F to 400° F	==
Temperature Capability Adapters with O-Ring**	All Style of Adapter	-30 F to 250° F	-30 F to 250° F	-30 F to 250° F

* For details see Working Pressure Charts in the individual adapters section

** For details concerning O-ring see section "O-ring selection" and "Fluid Resistance Table"

ADAPTERS GUIDELINES

JIC 37° ADAPTER (ISO 8431-2, SAE J514)

Main Features

Adapters are designed and manufactured according to SAE J514 and ISO 8434-2, and commonly called 37° JIC Adapters.

37° JIC adapter performs extremely well in all high pressure applications.

The seal is made by connecting a 37° flared tube surface to a 37° flare male and tightening by means of a nut and a sleeve.

The flared tube avoids welded connection, so high performances are guaranteed even in case of severe vibrations, mechanic/hydraulic shocks and multiple assembly/disassembly operations.

When tightened, sleeve provides tube and adapter self alignment and helps to reduce the vibrations on the tube during application.

An appropriate choice of sleeve gives the possibility of assembling adapters with both metric and inch-tubes

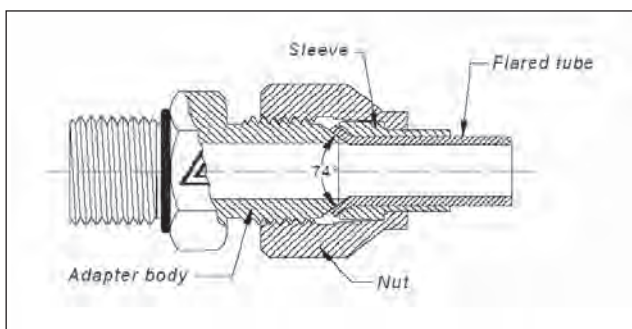

Flaring Operations

Perfect sealing is guaranteed with tubes having physical and mechanical characteristics obtained by cold-drawing and a ductility expressed as 21% of minimum elongation.

Also is necessary to follow a correct flaring procedure:

- Cut end of tube must be perpendicular to its axis . Note: cutting operation reduces the whole length of tube (almost $0,5\pm 1\text{mm}$ for each end).
- Dimensions of the end of the tube shall allow the correct placing on the flaring machine.
- Flared surface must be inspected to avoid excessive roughness and defects such as cracks or exfoliation.
- Length of flared zone shall be enough to allow a sufficient sealing surface and avoid the blowing off of the tube, but not excessive to prevent the contact with thread of the nut.

A well followed flaring procedure assures no leakage even after frequent assembling and disassembling operations.

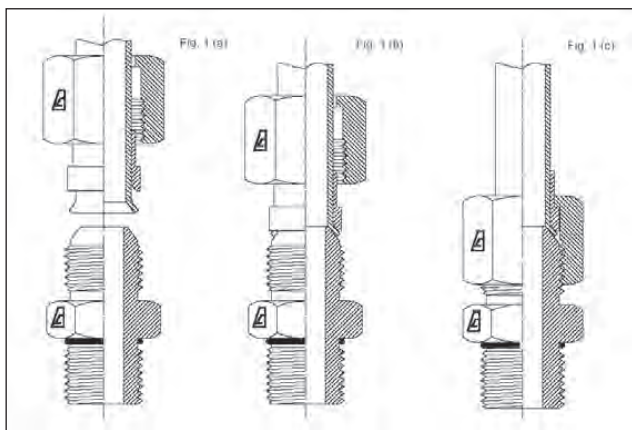

ORFS ADAPTER (ISO 8431-3, SAE J1453)

Main Features

Adapters are designed and manufactured according to standard SAE J1453 and commonly called ORFS adapters. O-Ring Face Seal adapters performs extremely well in all high pressure applications where elastomeric seals are needed to overcome leakage and leak resistance is crucial.

A seal is made when the O-Ring in the male contacts the 180° flat face of the tube. The male connector has a straight thread and a machined flat face. The seal takes place by compressing the O-Ring onto the flat face of the female.

ORFS system is composed by:

- Nut.
- Sleeve for flat tube and a shouldered sleeve for brazing. An appropriate choice of sleeve gives the possibility of assembling adapters with both metric and inch-tubes.
- Various kind and size of adapter body.
- O-Ring material is NBR, Shore "A": 90, suitable for a temperature range of: $-30^{\circ}\text{C}/+130^{\circ}\text{C}$ ($-22^{\circ}\text{F}/+266^{\circ}\text{F}$).

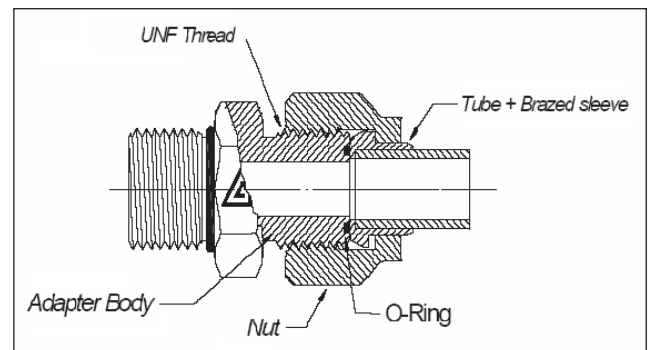

Flaring Tube Operations

Perfect sealing is guaranteed with tubes having physical and mechanical characteristics obtained by cold-drawing and a ductility expressed as 21% of minimum elongation.

Also it is necessary to follow a correct flaring procedure:

- Cut end of tube must be perpendicular to its axis.
- Cutting operation reduce the whole length of tube.
- Dimensions of the end of the tube shall allow the correct placing on the flaring machine.
- Flared surface must be inspected to avoid excessive roughness and defects such as cracks or exfoliation.
- Brazing sleeve guarantees the same performances as the flared tube, and shall be used in the following cases:
 - Tube is not in accordance with the above mechanical characteristics.
 - The straight part of the tube is not of a sufficient length (see quote L2 and values listed in table of figure O-3).
 - Tube thickness is lower than values listed in table (O-1).
 - For cutting length consider shoulder of the sleeve (quote L1 of table O-1).

A well followed flaring procedure assures no leakage even after frequent assembling and disassembling operations.

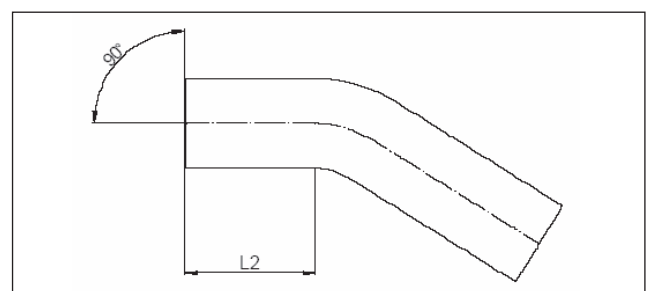

Hose mm	L2 Min mm
Ø 6-Ø 12	73
Ø 14-Ø 18	100
Ø 20-Ø 22	120
Ø 25-Ø 42	130

Only a few simple operations are required for assembling ORFS tube/adaptor.

1) Sleeve and Tube Flared:

- Place nut and sleeve on the tube with the appropriate orientation.
- Flare the tube (See procedure)
- Place the tube near seal surface of the adapter and screw by hand.
- Lock the adapter and tighten with a torque wrench.

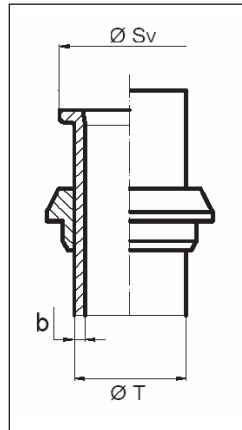

2) Brazed sleeve

- Cut the tube considering quote L1 of the sleeve (See Figure O-5);
- Clean and degrease accurately the end of the tube and the sleeve;
- Put the brazing ring into the sleeve
- Apply flux at the end of the tube and in the sleeve, then assemble the sleeve on the tube;
- Start brazing and be aware of not overheating flux material;
- Clean the connecting part and verify the good quality of weld around the external diameter of the hose;
- Complete the assembly procedure as described in points 3a) and 4a). See the correct installation torque in the attached table (O-2).

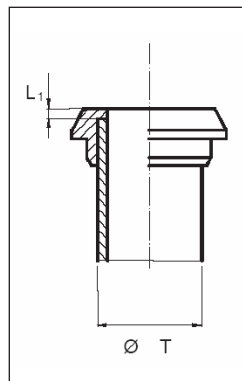

BSP ADAPTER (ISO 8431-6, BS 5200)

Main Features

Adapters are designed and manufactured according to standard BS 5200, ISO 8434-6 and ISO 228-1 and they are commonly called BSP adapters (British Standard Pipe) BSP adapter is widely employed, it performs extremely well in all high pressure applications with oil and gas.

The seal is made by connecting a 60° coned seat to the 60° male surface and tightening the nut assembly. The O-Ring placed in the tube groove improves the sealing.

There are not welded part in the locking area and performances are good even after multiple assembly and disassembly operations, severe vibrations and mechanic/hydraulic shocks.

Assembling Procedure

Only a few simple operations are required for assembling BSP tube/adaptor:

- Carefully align tube and adapter. Otherwise sealing is not guaranteed.
- Lubricate accurately sealing surfaces with mineral oil or suitable lubricant.
- Place the tube near seal surface of the adapter and tight by hand.
- Lock the adapter and tighten with a torque wrench. See the correct installation torque in the attached table B-1

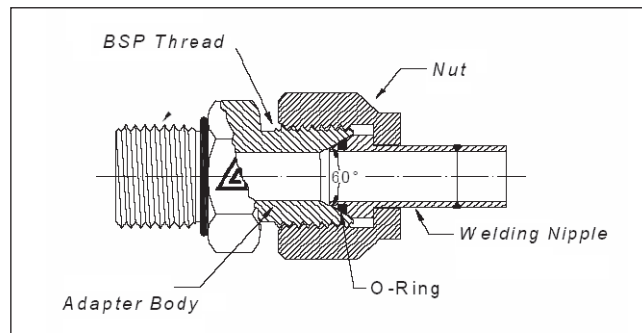

Assembly Instruction For Adjustable Adapter Thread: SAE, UNF, BSPP, Metric

Lubricate the O-Ring with mineral oil. Back off locknut as for as possible.

Make sure that washer is pushed-up as much as possible. Screw by hand the adapter into the port until the ORing enter the port.

To align adapter orientation to tube end or hose assembly, unscrew the adapter by the required amount, but not more than one full turn.

Hold the adapter in desired position by mean of a wrench and tighten locknut to the suggested torque value by means of a dynamometric wrench.

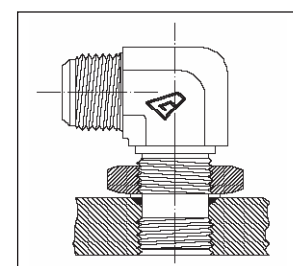
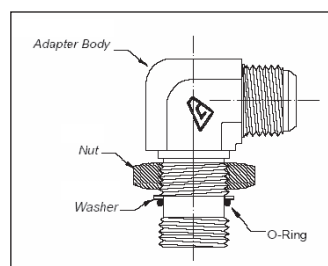

Hose		SV	
mm	in	min	max
6	1/4	12.0	12.7
8	5/16	14.7	15.7
10	3/8	14.7	15.7
12	1/2	17.9	18.9
15		22.1	23.4
16	5/8	22.1	23.4
18		26.3	27.8
20	3/4	26.3	27.8
22		32.4	34.2
25	1	32.4	34.2
28		39.0	40.5
30		39.0	40.5
32	1 1/4	39.0	40.5
35		46.0	48.5
38	1 1/2	46.0	48.5

METRIC PORT - ISO 6149 - SAE 2244-1

Metric Thread	D2 ²⁾ min	D3 ³⁾ min	D5 +0,1 0	D6 +0,5 0	L1 +0,4 0	L2 min	L3 max	L4	Z° +-1°	Assembly Torque +10% 0
D1	mm	mm	mm	mm	mm	mm	mm	mm		Nm
M8 X 1	17	14	9.1	14	1.6	11.5	1	10	12°	10
M10 X 1	20	16	11.1	16	1.6	11.5	1	10	12°	20
M12 X 1.5	23	19	13.8	19	2.4	14	1.5	11.5	15°	35
M14 X 1.5 ¹⁾	25	21	15.8	21	2.4	14	1.5	11.5	15°	45
M16 X 1.5	28	24	17.8	24	2.4	15.5	1.5	13	15°	55
M18 X 1.5	30	28	19.8	26	2.4	17	2	14.5	15°	70
M22 X 1.5	34	29	23.8	29	2.4	18	2	15.5	15°	100
M27 X 3	40	34	29.4	34	3.1	22	2	19	15°	170
M33 X 2	49	43	35.4	43	3.1	22	2.5	19	15°	310
M42 X 2	60	52	44.4	52	3.1	22.5	2.5	19.5	15°	330
M48 X 2	66	57	50.4	57	3.1	25	2.5	22	15°	420
M60 X 2	76	67	52.4	67	3.1	27.5	2.5	24.5	15°	500

- 1) Preferred for diagnostic port application
- 2) Spotface diameter with identification ridge
- 3) Spotface diameter without identification ridge

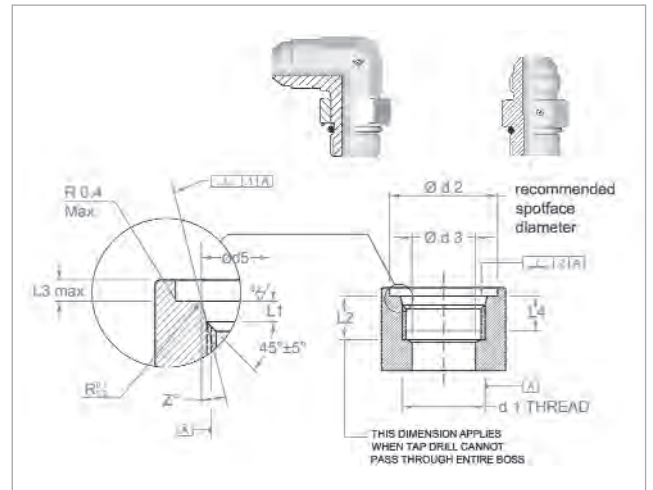

SAE UNF PORT - SAE J1926-1 - ISO 11926

ANSI B1.1 Thread	D2	D3 +0,13 min	D3 +0,4 0	L1 +0,4 0	L2 min	L3 max	L4	Z° +-1°	Assembly Torque +10% 0
D1	mm	mm	mm	mm	mm	mm	mm		Nm
7/16-20	21	4.4	12.4	2.4	14	1.6	11.5	12°	20
1/2-20	23	6	14	2.4	14	1.6	11.5	12°	25
9/16-18	25	7.5	15.6	2.5	15.5	1.6	12.7	12°	35
3/4-16	30	10	20.6	2.5	17.5	2.4	14.3	15°	70
7/8-14	34	12.5	23.9	3.3	20	2.4	16.7	15°	100
1.1/16-12	41	16	29.2	3.3	23	2.4	19	15°	170

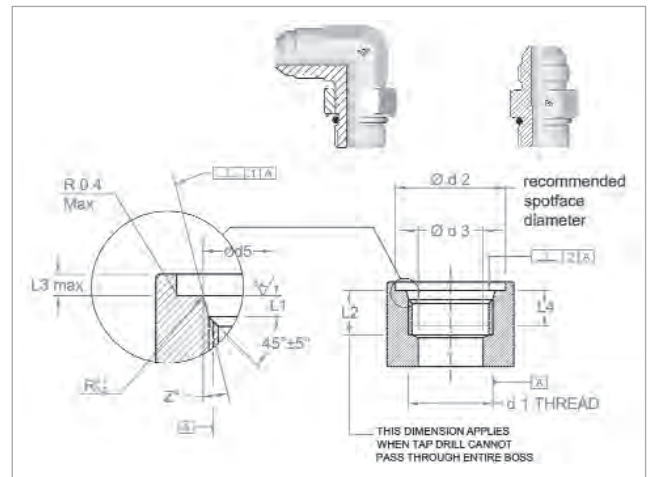

BSPP PORT - ISO 9974 - DIN 3852-1

ANSI B1.1 Thread	D3 +0.2 0	D4	L1 max	L2 min	Assembly Torque +10% 0
D1	mm	mm	mm	mm	Nm
1/8-28	9.8	15	1	8	20
1/4-19	13.2	20	1.5	12	50
3/8-19	16.7	23	2	12	80
1/2-14	21	28	2.5	14	100
3/4-14	26.5	33	2.5	16	200
1-11	33.3	41	2.5	18	380
1.1/4-11	42	51	2.5	20	500
1.1/2-11	47.9	56	2.5	22	600

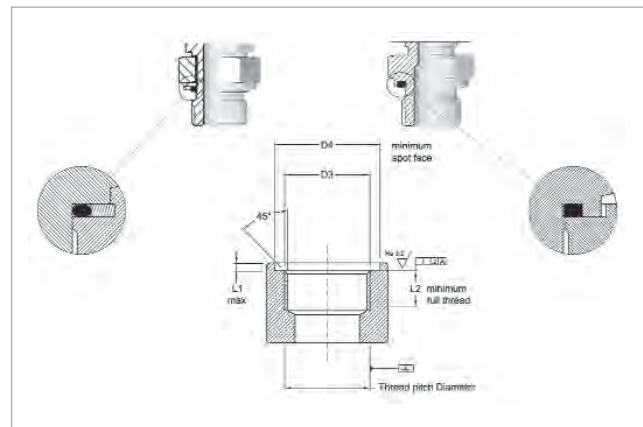

METRIC PORT - ISO 9974 - DIN 3852-1

Metric Thread	D3 +0.2 0	D4 min	L1 max	L2 min	Assembly Torque +10% 0
D1	mm	mm	mm	mm	Nm
M12 X 1.5	12	18	1.5	12	35
M14 X 1.5	14	20	1.5	12	45
M16 X 1.5	16	23	1.5	12	55
M18 X 1.5	18	25	2	12	68
M20 X 1.5	20	27	2	14	80
M22 X 1.5	22	28	2.5	14	98
M27 X 2	27	33	2.5	16	180
M33 X 2	33	41	2.5	18	310
M42 X 2	42	51	2.5	20	330
M48 X 2	48	56	2.5	22	400

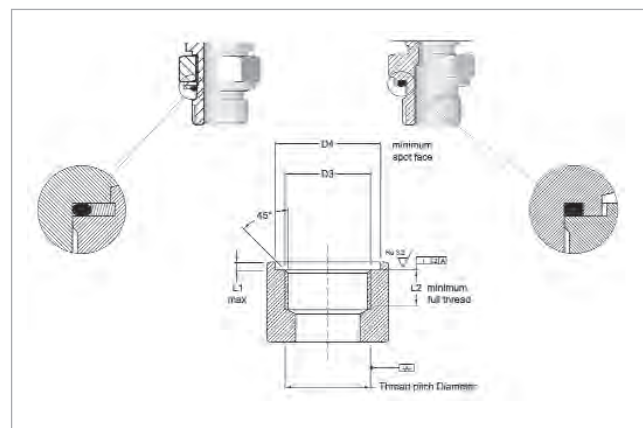



HYDRAULIC HOSE

TEXTILE BRAID35

WIRE BRAID.....36

WIRE SPIRAL39



ALFATECH41

HIGH TEMPERATURE47

OIL RETURN LINES48

VISUAL INDEX

TEXTILE BRAID

	FLEXOR 6 EN 854 R6, SAE 100 R6	35
	FLEXOR 3 EN 854 R3, SAE 100 R3	35

WIRE BRAID

	FLEXOR 1SN-R1AT MSHA EN 853 1SN, SAE 100 R1AT, ISO 1436 1SN/R1AT	36
	FLEXOR 2SN-R2AT MSHA EN 853 2SN, SAE 100 R2AT, ISO 1436 2SN/R2AT	36
	FLEXOR 2ST-R2A MSHA EN 853 2ST, SAE 100 R2A, ISO 1436 2ST	37
	FLEXOR 5 SAE 100 R5	37
	FLEXOPAK 1SC EN 857 1SC, ISO 11237 1SC	38
	FLEXOPAK 2SC EN 857 2SC, SAE 100 R16, ISO 11237 2SC	38

WIRE SPIRAL

	FLEXOR 4SP EN 856 4SP, ISO 3862 4SP	39
	FLEXOR 4SH EN 856 4SH, ISO 3862 4SH	39
	FLEXOR 12 SAE 100 R12, EN 856 R12, ISO 3862 R12	40

WIRE SPIRAL



FLEXOR 13
SAE 100 R13, EN 856 R13, ISO 3862 R13

40

ALFATECH

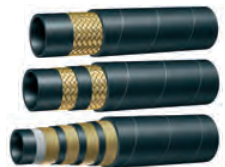

AT3K
AT3K-1B, AT3K-2B, AT3K-4S

41



AT4K
AT4K-2B, AT4K-4S

42



AT5K
AT5K-2B, AT5K-4S, AT5K-6S

43



AT6K
AT6K-4S, AT6K-6S

44



AT7K
AT7K-6S

44



AT8K
AT8K

44



AT4K SUPERTUFF
AT4K-2B, AT4K-4S

45



AT5K SUPERTUFF
AT5K-2B, AT5K-4S, AT5K-6S

46

VISUAL INDEX

ALFATECH

	<p>AT6K SUPERTUFF AT6K-4S, AT6K-6S</p>	<p>46</p>
---	---	------------------

HIGH TEMPERATURE

	<p>TEMP TECH 1SN EN 853 1SN, SAE 100 R1AT, ISO 1436 1SN/R1AT</p>	<p>47</p>
---	---	------------------

	<p>TEMP TECH 2SN EN 853 2SN, SAE 100 R2AT, ISO 1436 2SN/R2AT</p>	<p>47</p>
---	---	------------------

OIL RETURN LINES

	<p>FLEXOR T604 SAE 100 R4</p>	<p>48</p>
--	--	------------------

FLEXOR 6

SAE 100 R6, EN 854 R6 (up to 3/4")

Tube: oil resistant synthetic rubber.

Reinforcement: one high tensile textile braid.

Cover: abrasion, ozone and hydrocarbon resistant synthetic rubber.

Application: low pressure hydraulic lines, fuel oil, antifreeze solutions, air and water. Specially designed for use in "PUSH ON" applications.

Continuous service temperature range:

-40 °C +100 °C (-40 °F +212 °F)

Air max T = +70 °C (+160 °F)

Length: random



Dash	↔		↔		⬇		⬇		⤴		⬆	
	mm	in	mm	in	Mpa	psi	Mpa	psi	mm	in	kg/m	lb/C ft
-04	6	1/4	12.7	0.5	2.8	400	11	1600	64	2.6	0.13	9
-05	8	5/16	14.3	0.56	2.8	400	11	1600	76	3	0.13	9
-06	10	3/8	15.9	0.63	2.8	400	11	1600	76	3	0.17	11
-08	13	1/2	19.8	0.78	2.8	400	11	1600	102	4.1	0.23	15
-10	16	5/8	23	0.91	2.4	350	10	1400	107	4.3	0.27	18
-12	19	3/4	26.9	1.06	2.1	300	8	1200	152	6.1	0.37	25
-16	25	1	33.4	1.31	1.7	250	7	1000	203	8.1	0.49	33

FLEXOR 3

SAE 100 R3, EN 854 R3

Tube: oil resistant synthetic rubber.

Reinforcement: two high tensile textile braids.

Cover: abrasion, ozone and hydrocarbon resistant synthetic rubber.

Application: medium pressure hydraulic lines, fuel oil, antifreeze solutions, air and water.

Continuous service temperature range:

-40 °C +100 °C (-40 °F +212 °F)

Air max T = +70 °C (+160 °F)

Length: random

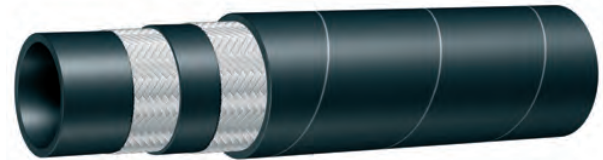

Dash	↔		↔		⬇		⬇		⤴		⬆	
	mm	in	mm	in	Mpa	psi	Mpa	psi	mm	in	kg/m	lb/C ft
-04	6	1/4	14.3	0.56	8.6	1250	35	5000	76	3	0.18	12
-05	8	5/16	17.5	0.69	8.3	1200	33	4800	102	4.1	0.24	16
-06	10	3/8	19.1	0.75	7.8	1125	31	4500	102	4.1	0.25	17
-08	13	1/2	23.8	0.94	7	1000	28	4000	127	5.1	0.38	25
-10	16	5/8	27	1.06	6	875	24	3500	140	5.6	0.46	31
-12	19	3/4	31.8	1.25	5.2	750	21	3000	152	6.1	0.63	42
-16	25	1	38.1	1.5	3.9	565	16	2260	203	8.1	0.76	51
-20	32	1 1/4	45	1.77	2.6	377	10	1508	254	10.2	0.94	63

WIRE BRAID



FLEXOR 1SN-R1AT MSHA

**EN 853 1SN, SAE 100 R1AT
ISO 1436 1SN/R1AT
(up to 2")**



Tube: oil resistant synthetic rubber.
Reinforcement: one high tensile steel braid (1B).
Cover: abrasion, ozone and hydrocarbon resistant synthetic rubber
 MSHA approved.
Application: high pressure hydraulic lines, fuel oil, antifreeze solutions, air and water.
Continuous service temperature range:
 -40 °C +100 °C (-40 °F +212 °F)
 Air max T = +70 °C (+160 °F)
Length: random up to 1" - 40m / 61m max for 1 1/4" and over

Dash	mm	in	mm	in	Mpa	psi	Mpa	psi	mm	in	kg/m	lb/C ft
-03	5	3/16	11.8	0.46	25	3630	100	14520	90	3.6	0.18	12
-04	6	1/4	13.4	0.53	22.5	3270	90	13080	100	4	0.22	15
-05	8	5/16	15	0.59	21.5	3120	86	12480	115	4.6	0.26	17
-06	10	3/8	17.4	0.69	18	2610	72	10460	130	5.2	0.33	22
-08	13	1/2	20.6	0.81	16	2320	64	9280	180	7.2	0.42	28
-10	16	5/8	23.7	0.93	13	1890	52	7560	200	8	0.51	34
-12	19	3/4	27.7	1.09	10.5	1530	42	6120	240	9.6	0.62	42
-16	25	1	35.6	1.4	8.8	1280	35	5120	300	12	0.92	62
-20	32	1 1/4	43.5	1.71	6.3	920	25	3680	420	16.8	1.2	80
-24	38	1 1/2	50.6	1.99	5	730	20	2920	500	20	1.48	99
-32	51	2	64	2.52	4	580	16	2320	630	25.2	2	134
-40	64	2 1/2	79	3.11	5	720	20	2880	760	30.4	2.89	194
-48	76	3	92	3.62	3.5	500	14	2000	900	36	3.43	230

FLEXOR 2SN-R2AT MSHA

**EN 853 2SN, SAE 100 R2AT
ISO 1436 2SN/R2AT**



Tube: oil resistant synthetic rubber.
Reinforcement: two high tensile steel braids (2B).
Cover: abrasion, ozone and hydrocarbon resistant synthetic rubber
 MSHA approved.
Application: high pressure hydraulic lines, fuel oil, antifreeze solutions, air and water.
Continuous service temperature range:
 -40 °C +100 °C (-40 °F +212 °F)
 Air max T = +70 °C (+160 °F)
Length: random up to 1" - 40m / 61m max for 1 1/4" and over

Dash	mm	in	mm	in	Mpa	psi	Mpa	psi	mm	in	kg/m	lb/C ft
-03	5	3/16	13.4	0.53	42	6000	168	24000	90	3.6	0.29	19
-04	6	1/4	15	0.59	40	5800	160	23200	100	4	0.36	24
-05	8	5/16	16.7	0.66	35	5000	140	20000	115	4.6	0.42	28
-06	10	3/8	19.1	0.75	33	4800	132	19200	125	5	0.51	34
-08	13	1/2	22.2	0.87	27.5	4000	110	16000	175	7	0.64	43
-10	16	5/8	25.4	1	25	3630	100	14520	200	8	0.74	50
-12	19	3/4	29.3	1.15	21.5	3120	86	12480	240	9.6	0.91	61
-16	25	1	38.1	1.5	16.5	2400	66	9600	300	12	1.32	88
-20	32	1 1/4	48.3	1.9	12.5	1820	50	7280	420	16.8	1.93	129
-24	38	1 1/2	54.6	2.15	9	1310	36	5240	500	20	2.41	161
-32	51	2	67.4	2.65	8	1160	32	4640	630	25.2	2.96	198

FLEXOR 2ST-R2A MSHA

EN 853 2ST, SAE 100 R2A
ISO 1436 2ST
(up to 2")

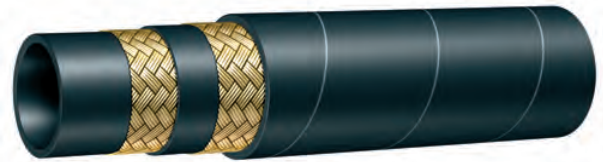

Tube: oil resistant synthetic rubber.

Reinforcement: two high tensile steel braids (2B).

Cover: abrasion, ozone and hydrocarbon resistant synthetic rubber MSHA approved.

Application: high pressure hydraulic lines, fuel oil, antifreeze solutions, air and water.

Continuous service temperature range:

-40 °C +100 °C (-40 °F +212 °F)

Air max T = +70 °C (+160 °F)

Length: random up to 1" - 40m / 61m max for 1 1/4" and over

Dash	↔		↔		⌚		⌚		⌒		⌚	
	mm	in	mm	in	Mpa	psi	Mpa	psi	mm	in	kg/m	lb/C ft
-04	6	1/4	17.5	0.69	40	5714	160	23200	100	4	0.42	28
-05	8	5/16	19.1	0.75	35	5000	140	20000	115	4.6	0.5	34
-06	10	3/8	21.4	0.84	33	4714	132	19200	130	5.2	0.6	40
-08	13	1/2	24.6	0.97	27.5	3929	110	16000	180	7.2	0.74	50
-10	16	5/8	27.8	1.09	25	3571	100	14520	200	8	0.86	58
-12	19	3/4	31.8	1.25	21.5	3071	86	12480	240	9.6	1.05	70
-16	25	1	39.7	1.56	16.5	2357	66	9600	300	12	1.41	94
-20	32	1 1/4	50.8	2	12.5	1786	50	7280	420	16.8	2.14	143
-24	38	1 1/2	57.2	2.25	9	1286	36	5240	500	20	2.55	171
-32	51	2	69.8	2.75	8	1143	32	4640	630	25.2	3.34	224
-40	64	2 1/2	83	3.27	7	1000	28	4000	760	30.4	3.96	265
-48	76	3	96	3.78	5.5	800	22	3200	900	36	4.96	332

FLEXOR 5

SAE 100 R5, J1402 DOT AII FM VSS 106



Tube: oil resistant synthetic rubber.

Reinforcement: one high tensile steel braid.

Cover: braided high tensile textile cord.

Application: medium pressure hydraulic lines, fuel oil, antifreeze solutions, air and water.

Continuous service temperature range:

-40 °C +100 °C (-40 °F +212 °F)

Air max T = +70 °C (+160 °F)

Length: random

Dash	↔		↔		⌚		⌚		⌒		⌚	
	mm	in	mm	in	Mpa	psi	Mpa	psi	mm	in	kg/m	lb/C ft
-04	5	3/16	13.2	0.52	20.7	3000	83	12000	76	3	0.23	15
-05	6	1/4	14.8	0.58	20.7	3000	83	12000	86	3.4	0.27	18
-06	8	5/16	17.3	0.68	15.5	2250	62	9000	102	4.1	0.34	23
-08	11	13/32	19.5	0.77	13.8	2000	55	8000	117	4.7	0.45	30
-10	13	1/2	23.4	0.92	12.1	1750	48	7000	140	5.6	0.56	37
-12	16	5/8	27.4	1.08	10.3	1500	41	6000	165	6.6	0.67	45
-16	22	7/8	31.4	1.24	5.5	800	22	3200	187	7.5	0.69	46
-20	29	1 1/8	38.1	1.5	4.3	625	17	2500	229	9.2	0.84	57
-24	35	1 3/8	44.5	1.75	3.4	500	14	2000	267	10.7	1.06	71
-32	46	1 13/16	56.4	2.22	2.4	350	10	1400	337	13.5	1.35	90

WIRE BRAID



FLEXOPAK 1SC

**EN 857 1SC
ISO 11237 1SC**



Tube: oil resistant synthetic rubber.
Reinforcement: one high tensile steel braid (1B).
Cover: abrasion, ozone and hydrocarbon resistant synthetic rubber.
Application: high pressure hydraulic lines, fuel oil, antifreeze solutions, air and water.
Continuous service temperature range:
 -40 °C +100 °C (-40 °F +212 °F)
 Air max T = +70 °C (+160 °F)
Length: random

Dash	↔		↔		⊕		⊕		⌒		⚖	
	mm	in	mm	in	Mpa	psi	Mpa	psi	mm	in	kg/m	lb/C ft
-04	6	1/4	12.1	0.48	22.5	3250	90	13000	50	2	0.17	11
-05	8	5/16	14.1	0.56	21.5	3100	86	12400	55	2.2	0.19	13
-06	10	3/8	15.6	0.61	21	3000	84	12000	65	2.6	0.26	17
-08	13	1/2	19.5	0.77	16	2286	64	9143	90	3.6	0.41	27
-10	16	5/8	23	0.91	13	1890	52	7560	100	4	0.44	29
-12	19	3/4	26.7	1.05	10.5	1530	42	6120	125	5	0.57	38
-16	25	1	34.9	1.37	8.8	1280	35	5120	150	6	0.74	50

FLEXOPAK 2SC

**EN 857 2SC, SAE 100 R16
ISO 11237 2SC
(up to 2")**



Tube: oil resistant synthetic rubber.
Reinforcement: two high tensile steel braids (2B).
Cover: abrasion, ozone and hydrocarbon resistant synthetic rubber.
Application: high pressure hydraulic lines, fuel oil, antifreeze solutions, air and water.
Continuous service temperature range:
 -40 °C +100 °C (-40 °F +212 °F)
 Air max T = +70 °C (+160 °F)
Length: random

Dash	↔		↔		⊕		⊕		⌒		⚖	
	mm	in	mm	in	Mpa	psi	Mpa	psi	mm	in	kg/m	lb/C ft
-04	6	1/4	13.2	0.52	40	5800	160	23200	75	3	0.27	18
-05	8	5/16	14.5	0.57	35	5000	140	20000	85	3.3	0.31	21
-06	10	3/8	17	0.67	33	4800	132	19200	90	3.5	0.36	24
-08	13	1/2	20.3	0.80	27.5	4000	110	16000	130	5.1	0.47	31
-10	16	5/8	23.9	0.94	25	3630	100	14520	170	6.7	0.57	38
-12	19	3/4	27.7	1.09	21.5	3120	86	12480	200	7.9	0.76	51
-16	25	1	34.6	1.36	16.5	2400	66	9600	250	9.8	1.13	76
-20	32	1 1/4	43.5	1.70	16.5	2400	66	9600	360	14.2	1.50	100
-24	38	1 1/2	50.9	2.00	13.5	1930	54	7720	430	16.9	1.97	131
-32	51	2	63.9	2.51	10	1430	40	5720	550	21.6	2.55	170
-40	63	2 1/2	76.5	3.00	7	1000	28	4000	720	28.3	3.04	202
-48	76	3	91.2	3.59	7	1000	28	4000	880	34.6	4.08	272

FLEXOR 4SP

EN 856 4SP
ISO 3862 4SP

Tube: oil resistant synthetic rubber.

Reinforcement: four high tensile steel spirals (4S).

Cover: abrasion, ozone and hydrocarbon resistant synthetic rubber
MSHA approved.

Application: very high pressure hydraulic lines, fuel oil, antifreeze solutions, air and water.

Continuous service temperature range:

-40 °C +100 °C (-40 °F +212 °F)

Length: random



Dash	mm	in	mm	in	Mpa	psi	Mpa	psi	mm	in	kg/m	lb/C ft
-04	6	1/4	17.9	0.7	45	6550	180	26200	150	6	0.58	39
-06	10	3/8	21.4	0.84	44.5	6450	178	25800	180	7.2	0.74	50
-08	13	1/2	24.6	0.97	41.5	6000	166	24000	230	9.2	0.88	59
-10	16	5/8	28.2	1.11	35	5000	140	20000	250	10	1.05	71
-12	19	3/4	32.2	1.27	38	5510	152	22040	300	12	1.44	96
-16	25	1	39.7	1.56	32	4640	128	18560	340	13.6	1.96	131

FLEXOR 4SH

EN 856 4SH
ISO 3862 4SH

Tube: oil resistant synthetic rubber.

Reinforcement: four high tensile steel spirals (4S).

Cover: abrasion, ozone and hydrocarbon resistant synthetic rubber
MSHA approved.

Application: very high pressure hydraulic lines, fuel oil, antifreeze solutions, air and water.

Continuous service temperature range:

-40 °C +100 °C (-40 °F +212 °F)

Length: random up to 1" - 40m / 61m max for 1 1/4" and over



Dash	mm	in	mm	in	Mpa	psi	Mpa	psi	mm	in	kg/m	lb/C ft
-12	19	3/4	32.2	1.27	42	6000	168	24000	280	11.2	1.57	106
-16	25	1	38.7	1.52	38	5500	152	22000	340	13.6	1.95	131
-20	32	1 1/4	45.5	1.79	35	5000	140	20000	460	18.4	2.47	165
-24	38	1 1/2	53.5	2.11	29	4200	116	16800	560	22.4	3.27	219
-32	51	2	68.1	2.68	25	3650	110	14600	700	28	4.67	313

WIRE SPIRAL



FLEXOR 12

SAE 100 R12, EN 856 R12
ISO 3862 R12



Tube: oil resistant synthetic rubber.
Reinforcement: four high tensile steel spirals (4S).
Cover: abrasion, ozone and hydrocarbon resistant synthetic rubber
 MSHA approved. Grey cover also available.
Application: very high pressure hydraulic lines, fuel oil, antifreeze solutions, air and water.
Continuous service temperature range:
 -40 °C +121 °C (-40 °F +250 °F)
Length: random up to 1" - 40m / 61m max for 1 1/4" and over

Dash	mm	in	mm	in	Mpa	psi	Mpa	psi	mm	in	kg/m	lb/C ft
-06	10	3/8	20.3	0.8	28	4000	112	16000	127	5.1	0.65	44
-08	13	1/2	23.8	0.94	28	4000	112	16000	178	7.1	0.81	54
-10	16	5/8	27.4	1.08	28	4000	112	16000	203	8.1	1.08	72
-12	19	3/4	30.7	1.21	28	4000	112	16000	241	9.6	1.27	85
-16	25	1	38	1.5	28	4000	112	16000	305	12.2	1.79	120
-20	32	1 1/4	47	1.85	21	3000	84	12000	419	16.8	2.74	184
-24	38	1 1/2	53.5	2.11	17.5	2500	70	10000	508	20.3	3.14	210
-32	51	2	66.7	2.63	17.5	2500	70	10000	635	25.4	4.04	217
-40	63	2 1/2	81.2	3.19	14	2030	56	8120	720	28.3	6.36	426

FLEXOR 13

SAE 100 R13, EN 856 R13
ISO 3862 R13



Tube: oil resistant synthetic rubber.
Reinforcement: four/six high tensile steel spirals (4S/6S).
Cover: abrasion, ozone and hydrocarbon resistant synthetic rubber
 MSHA approved. Red cover also available.
Application: very high pressure hydraulic lines, fuel oil, antifreeze solutions, air and water.
Continuous service temperature range:
 -40 °C +121 °C (-40 °F +250 °F)
Length: random up to 1" - 40m / 61m max for 1 1/4" and over

Constr.	Dash	mm	in	mm	in	Mpa	psi	Mpa	psi	mm	in	kg/m	lb/C ft
4S	-12	19	3/4	32.1	1.26	35	5000	140	20000	241	9.6	1.6	107
4S	-16	25	1	38.7	1.52	38	5500	152	22000	305	12.2	2	134
6S	-20	32	1 1/4	49.8	1.96	35	5000	140	20000	419	16.8	3.6	241
6S	-24	38	1 1/2	57.3	2.26	35	5000	140	20000	508	20.3	4.8	322
6S	-32	51	2	70.9	2.79	35	5000	140	20000	635	25.4	6.6	442

AT3K

1,000,000 impulse cycles*

Tube: oil resistant synthetic rubber.

Reinforcement: one/two high tensile steel braids or four high tensile steel spirals (1B/2B, 4S).

Cover: abrasion, ozone and hydrocarbon resistant synthetic rubber MSHA approved.

Application: high pressure hydraulic lines, fuel oil, antifreeze solutions, air and water.

Continuous service temperature range:

-40 °C +100 °C (-40 °F +212 °F) wire braid;

-40 °C +121 °C (-40 °F +250 °F) wire spiral.

Length: random up to 1" - 40m / 61m max for 1 1/4" and over

Norms:

SAE 100 R17

ISO 11237 R17

EN 857 1SC (1/4, 5/16, 3/8)

EXCEEDS EN 857 2SC, SAE 100 R16 (3/4)

SAE 100 R12 (1 1/4)

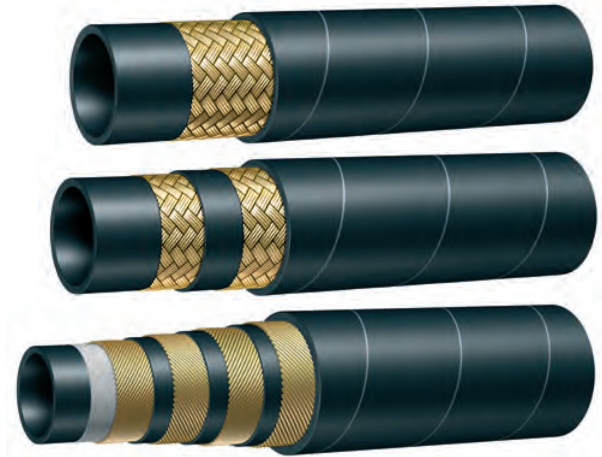

Constr.	Dash	↔		↔		⏚		⏚		⤴		⏚	
		mm	in	mm	in	Mpa	psi	Mpa	psi	mm	in	kg/m	lb/C ft
1B	-03	5	3/16	10.5	0.41	21	3000	84	12000	40	1.6	0.15	10
1B	-04	6	1/4	12.1	0.48	22.5	3250	90	13000	50	2	0.17	11
1B	-05	8	5/16	14.1	0.56	21.5	3100	86	12400	55	2.2	0.19	13
1B	-06	10	3/8	15.6	0.61	21	3000	84	12000	65	2.6	0.26	17
1B	-08	13	1/2	19.5	0.77	21	3000	84	12000	90	3.6	0.36	24
2B	-10	16	5/8	23.7	0.93	21	3000	84	12000	105	4.2	0.61	41
2B	-12	19	3/4	27.7	1.09	24	3500	96	14000	125	5	0.79	53
2B	-16	25	1	35.6	1.4	21	3000	84	12000	150	6	1.23	82
4S	-20	32	1 1/4	47	1.85	21	3000	84	12000	419	16.8	2.69	180

* Spiral construction

AT4K

1,000,000 impulse cycles*

Tube: oil resistant synthetic rubber.
Reinforcement: two high tensile steel braids or four high tensile steel spirals (2B, 4S).
Cover: abrasion, ozone and hydrocarbon resistant synthetic rubber MSHA approved.
Application: very high pressure hydraulic lines, fuel oil, antifreeze solutions, air and water.
Continuous service temperature range:
 -40 °C +100 °C (-40 °F +212 °F) wire braid;
 -40 °C +121 °C (-40 °F +250 °F) wire spiral.
Length: random up to 1" - 40m / 61m max for 1 1/4" and over
Norms:

SAE 100 R19
 ISO 11237 R16 (5/16, 3/8)
 EXCEEDS EN 857 2SC, SAE 100 R16 (1/2, 5/8)
 SAE 100 R12 (3/8, 1/2, 5/8, 3/4, 1)
 EN 856 4SH (1 1/2, 2)

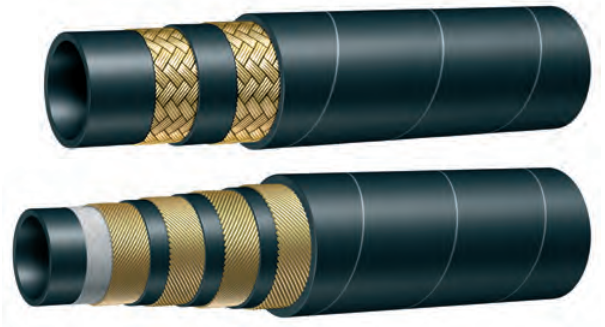

Constr.	Dash	↔		↔		↻		↻		↷		⚖	
		mm	in	mm	in	Mpa	psi	Mpa	psi	mm	in	kg/m	lb/C ft
2B	-05	8	5/16	14.5	0.57	29.3	4250	117	17000	57	2.3	0.3	20
2B	-06	10	3/8	17	0.67	28	4000	112	16000	64	2.6	0.36	24
2B	-08	13	1/2	20.6	0.81	31	4500	124	18000	90	3.6	0.52	35
2B	-10	16	5/8	23.7	0.93	28	4000	112	16000	101	4	0.6	40
2B	-12	19	3/4	29.3	1.15	28	4000	112	16000	130	5.2	0.98	66
4S	-06	10	3/8	20.3	0.8	28	4000	112	16000	64	2.6	0.61	41
4S	-08	13	1/2	23.8	0.94	28	4000	112	16000	90	3.6	0.82	55
4S	-10	16	5/8	27.4	1.08	28	4000	112	16000	100	4	1.1	74
4S	-12	19	3/4	30.7	1.21	28	4000	112	16000	130	5.2	1.23	82
4S	-16	25	1	38	1.5	28	4000	112	16000	150	6	1.8	121
4S	-20	32	1 1/4	47.5	1.87	28	4000	112	16000	230	9.2	2.47	165
4S	-24	38	1 1/2	53.5	2.11	29	4000	116	16800	560	22.4	3.27	219
4S	-32	51	2	68.1	2.68	28	4000	112	16000	590	23.6	4.67	313

* Spiral construction

AT5K

1,000,000 impulse cycles*

Tube: oil resistant synthetic rubber.

Reinforcement: two high tensile steel braids or four/six high tensile steel spirals (2B, 4S/6S).

Cover: abrasion, ozone and hydrocarbon resistant synthetic rubber MSHA approved.

Application: very high pressure hydraulic lines, fuel oil, antifreeze solutions, air and water.

Continuous service temperature range:

-40 °C +100 °C (-40 °F +212 °F) wire braid;

-40 °C +121 °C (-40 °F +250 °F) wire spiral.

Length: random up to 1" - 40m / 61m max for 1 1/4" and over

Norms:

ISO 11237 R16 (1/4)

EXCEEDS EN 857 2SC, SAE 100 R16 (5/16, 3/8)

EN 856 4SP (5/8, 3/4)

EN 856 4SH (1, 1 1/4)

SAE 100 R13 (1 1/4, 1 1/2, 2)

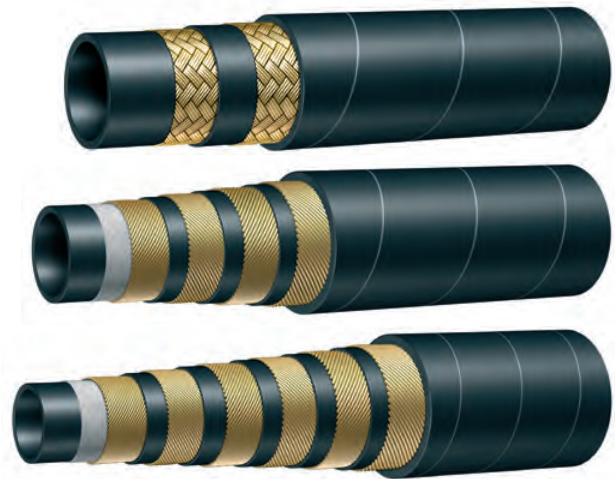

Constr.	Dash	↔		↔		⊙		⊙		∩		⬛	
		mm	in	mm	in	Mpa	psi	Mpa	psi	mm	in	kg/m	ib/C ft
2B	-04	6	1/4	13.2	0.52	35	5000	140	20000	51	2	0.25	17
2B	-05	8	5/16	15	0.59	37.5	5500	150	22000	57	2.3	0.3	20
2B	-06	10	3/8	17.4	0.59	35	5000	140	20000	64	2.6	0.4	27
2B	-08	13	1/2	22.2	0.87	35	5000	140	20000	80	3.2	0.67	45
2B	-10	16	5/8	25.4	1	35	5000	140	20000	100	4	0.8	53
4S	-10	16	5/8	28.2	1.11	35	5000	140	20000	125	5	1.05	70
4S	-12	19	3/4	32.2	1.27	38	5100	152	22040	140	5.6	1.49	100
4S	-16	25	1	38.7	1.52	38	5100	152	22040	190	7.6	1.94	130
4S	-20	32	1 1/4	45.5	1.79	35	5000	140	20000	240	9.6	2.47	165
6S	-20	32	1 1/4	49.8	1.96	35	5000	140	20000	210	8.4	3.59	241
6S	-24	38	1 1/2	57.3	2.26	35	5000	140	20000	475	19	4.83	324
6S	-32	51	2	71.1	2.8	35	5000	140	20000	545	21.8	6.54	438
6S	-40	63	2 1/2	83.8	3.3	35	5000	140	20000	895	35.2	8.77	588

* Spiral construction

AT6K

1,000,000 cycles tested

Tube: oil resistant synthetic rubber.
Reinforcement: four/six high tensile steel spirals (4S/6S).
Cover: abrasion, ozone and hydrocarbon resistant synthetic rubber MSHA approved.
Application: very high pressure hydraulic lines, fuel oil, antifreeze solutions, air and water.
Continuous service temperature range:
 -40 °C +121 °C (-40 °F +250 °F)
Length: random up to 1" - 40m / 61m max for 1 1/4" and over
Norms:
 SAE 100 R15
 EN 856 4SP (1/4, 3/8, 1/2)
 EN 856 4SH (3/4)

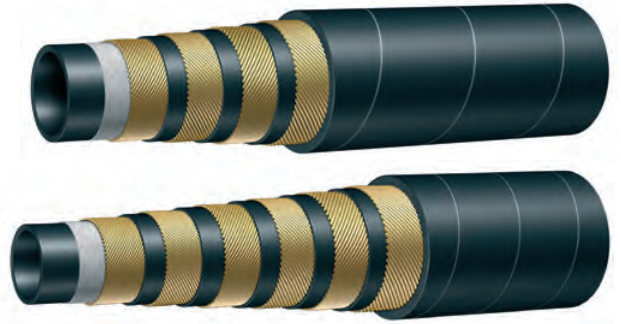

Constr.	↔			↔		⌚		⌚		⌒		⌚	
	Dash	mm	in	mm	in	Mpa	psi	Mpa	psi	mm	in	kg/m	lb/C ft
4S	-04	6	1/4	17.9	0.7	45	6550	180	26200	150	6	0.58	39
4S	-06	10	3/8	21.4	0.84	44.5	6450	178	25800	180	7.2	0.74	50
4S	-08	13	1/2	24.6	0.97	42	6000	166	24000	230	9.2	0.88	59
4S	-10	16	5/8	28.6	1.13	42	6000	168	24000	250	10	1.32	88
4S	-12	19	3/4	32.2	1.27	42	6000	168	24000	267	10.7	1.62	109
4S	-16	25	1	38.7	1.52	42	6000	168	24000	280	11.2	2.2	147
6S	-20	32	1 1/4	49.8	1.96	42	6000	168	24000	280	11.2	3.59	241
6S	-24	38	1 1/2	57.3	2.26	42	6000	168	24000	315	12.6	5	335
6S	-32	51	2	72	2.83	42	6000	168	24000	600	24	7.08	474

AT7K

1,000,000 cycles tested

Tube: oil resistant synthetic rubber.
Reinforcement: four high tensile steel spirals (4S).
Cover: abrasion, ozone and hydrocarbon resistant synthetic rubber MSHA approved.
Application: very high pressure hydraulic lines, fuel oil, antifreeze solutions, air and water.
Continuous service temperature range:
 -40 °C +121 °C (-40 °F +250 °F)
Length: random



↔			↔		⌚		⌚		⌒		⌚	
Dash	mm	in	mm	in	Mpa	psi	Mpa	psi	mm	in	kg/m	lb/C ft
-10	16	5/8	28.6	1.13	49	7000	196	28000	250	10	1.32	88

AT8K

1,000,000 cycles tested

Tube: oil resistant synthetic rubber.
Reinforcement: six high tensile steel spirals (6S).
Cover: abrasion, ozone and hydrocarbon resistant synthetic rubber MSHA approved.
Application: very high pressure hydraulic lines, fuel oil, antifreeze solutions, air and water.
Continuous service temperature range:
 -40 °C +121 °C (-40 °F +250 °F)
Length: random



↔			↔		⌚		⌚		⌒		⌚	
Dash	mm	in	mm	in	Mpa	psi	Mpa	psi	mm	in	kg/m	lb/C ft
-12	19	3/4	34.4	1.35	56	8000	224	32000	270	10.8	2.28	153
-16	25	1	42.1	1.66	56	8000	224	32000	300	12	3.22	216

AT4K SUPERTUFF

1,000,000 cycles tested*

Tube: oil resistant synthetic rubber.

Reinforcement: two high tensile steel braids or four high tensile steel spirals (2B/4S).

Cover: abrasion, ozone and hydrocarbon resistant synthetic rubber MSHA approved.

Application: very high pressure hydraulic lines, fuel oil, antifreeze solutions, air and water. Special "supertuff" cover for excellent abrasion resistance and long service life in heavy duty applications.

Continuous service temperature range:

-40 °C +100 °C (-40 °F +212 °F) wire braid;

-40 °C +121 °C (-40 °F +250 °F) wire spiral.

Length: random up to 1" - 40m / 61m max for 1 1/4" and over

Norms:

SAE 100 R19

ISO 11237 R16 (5/16, 3/8)

EXCEEDS EN 857 2SC, SAE 100 R16 (1/2, 5/8)

SAE 100 R12 (3/8, 1/2, 5/8, 3/4, 1)

EN 856 4SH (1 1/2, 2)

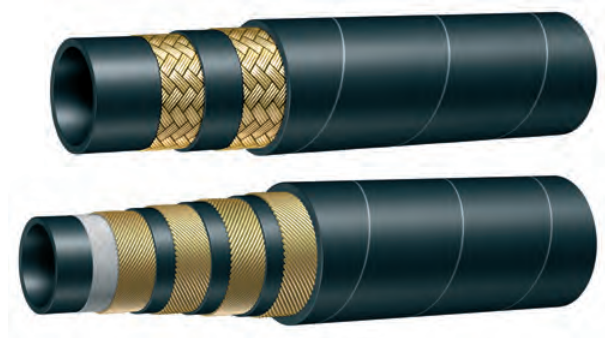

Constr.	Dash	↔		↔		⌚		⌚		⌒		📦	
		mm	in	mm	in	Mpa	psi	Mpa	psi	mm	in	kg/m	lb/C ft
2B	-05	8	5/16	14.5	0.57	29.3	4240	117	16000	57	2.3	0.31	21
2B	-06	10	3/8	17	0.67	28	4000	112	16000	64	2.6	0.37	25
2B	-08	13	1/2	20.6	0.81	31	4500	124	18000	90	3.6	0.54	36
2B	-10	16	5/8	23.7	0.93	28	4000	112	16000	101	4	0.62	42
4S	-12	19	3/4	30.7	1.21	28	4000	112	16000	130	5.2	1.24	83
4S	-16	25	1	38	1.5	28	4000	112	16000	150	6	1.81	122
4S	-20	32	1 1/4	47.5	1.87	28	4000	112	16000	230	9.2	2.48	166
4S	-24	38	1 1/2	53.5	2.11	29	4200	116	16800	450	18	3.28	220
4S	-32	51	2	68.1	2.68	28	4000	112	16000	590	23.6	4.68	314

* Spiral construction

AT5K SUPERTUFF

1,000,000 cycles tested*

Tube: oil resistant synthetic rubber.
Reinforcement: two high tensile steel braids or four/six high tensile steel spirals (2B, 4S/6S).
Cover: abrasion, ozone and hydrocarbon resistant synthetic rubber MSHA approved.
Application: very high pressure hydraulic lines, fuel oil, antifreeze solutions, air and water. Special "supertuff" cover for excellent abrasion resistance and long service life in heavy duty applications.
Continuous service temperature range:
 -40 °C +100 °C (-40 °F +212 °F) wire braid;
 -40 °C +121 °C (-40 °F +250 °F) wire spiral.
Length: random up to 1" - 40m / 61m max for 1 1/4" and over
Norms:
 ISO 11237 R16 (1/4)
 EXCEEDS EN 857 2SC, SAE 100 R16 (5/16, 3/8)
 EN 856 4SP (5/8, 3/4)
 EN 856 4SH (1, 1 1/4)
 SAE 100 R13 (1 1/4, 1 1/2, 2



Constr.	Dash	↔		↔		⏚		⏚		⤴		⏚	
		mm	in	mm	in	Mpa	psi	Mpa	psi	mm	in	kg/m	lb/C ft
2B	-04	6	1/4	13.2	0.52	35	5000	140	20000	51	2	0.27	18
2B	-05	8	5/16	15	0.59	37.5	5500	150	22000	57	2.3	0.32	21
2B	-06	10	3/8	17.4	0.69	35	5000	140	20000	64	2.6	0.4	27
2B	-08	13	1/2	22.2	0.87	35	5000	140	20000	150	6	0.66	44
4S	-10	16	5/8	28.2	1.11	35	5000	140	20000	125	5	1.05	70
4S	-12	19	3/4	32.2	1.27	38	5510	152	22040	140	5.6	1.45	97
4S	-16	25	1	38.7	1.52	38	5510	152	22040	190	7.6	1.94	130
4S	-20	32	1 1/4	45.1	1.78	35	5000	140	20000	210	8.4	2.47	165
6S	-20	32	1 1/4	49.8	1.96	35	5000	140	20000	210	8.4	3.59	241
6S	-24	38	1 1/2	57.3	2.26	35	5000	140	20000	475	19	4.88	327
6S	-32	51	2	71.7	2.8	35	5000	140	20000	545	21.8	6.62	444

* Spiral construction

AT6K SUPERTUFF

1,000,000 cycles tested

Tube: oil resistant synthetic rubber.
Reinforcement: four high tensile steel spirals (4B).
Cover: abrasion, ozone and hydrocarbon resistant synthetic rubber MSHA approved.
Application: very high pressure hydraulic lines, fuel oil, antifreeze solutions, air and water. Special "supertuff" cover for excellent abrasion resistance and long service life in heavy duty applications.
Continuous service temperature range:
 -40 °C +121 °C (-40 °F +250 °F)
Length: random
Norms:
 SAE 100 R15
 EN 856 4SP (3/8, 1/2)
 EN 856 4SH (3/4)



Dash	↔		↔		⏚		⏚		⤴		⏚	
	mm	in	mm	in	Mpa	psi	Mpa	psi	mm	in	kg/m	lb/C ft
-06	10	3/8	21.4	0.84	44.5	6450	178	25800	180	7.2	0.75	50
-08	13	1/2	24.6	0.97	42	6000	168	24000	230	9.2	0.9	60
-12	19	3/4	32.2	1.27	42	6000	168	24000	267	10.7	1.62	109
-16	25	1	38.7	1.52	42	6000	168	24000	280	11.2	2.2	147

TEMP TECH 1SN

EN 853 1SN, SAE 100 R1AT
ISO 1436 1SN/R1AT

Tube: oil resistant synthetic rubber.

Reinforcement: one high tensile steel braid (1B).

Cover: abrasion, ozone and hydrocarbon resistant synthetic rubber.

Application: high pressure hydraulic lines, fuel oil, antifreeze solutions, air and water. Specially designed for high temperature applications.

Continuous service temperature range:

-40 °C +150 °C (-40 °F +300 °F)

Air max T = +110 °C (+230 °F)

Length: random up to 1" - 40m / 61m max for 1 1/4" and over



Dash	↔		↔		⊕		⊕		⌒		Ⓜ	
	mm	in	mm	in	Mpa	psi	Mpa	psi	mm	in	kg/m	lb/C ft
-04	6	1/4	13.4	0.53	22.5	3270	90	13080	100	4	0.22	15
-06	10	3/8	17.4	0.68	18	2610	72	10460	130	5.2	0.32	21
-08	13	1/2	20.6	0.81	16	2320	64	9280	180	7.2	0.42	28
-10	16	5/8	23.7	0.93	13	1890	52	7560	200	8	0.51	34
-12	19	3/4	27.7	1.09	10.5	1530	42	6120	240	9.6	0.61	41
-16	25	1	35.6	1.4	8.8	1280	35	5120	300	12	0.93	62
-20	32	1 1/4	43.5	1.71	6.3	920	25	3680	420	16.8	1.29	86
-24	38	1 1/2	50.6	1.99	5	730	20	2920	500	20	1.48	99
-32	51	2	64	2.52	4	580	16	2320	630	25.2	2	134

TEMP TECH 2SN

EN 853 2SN, SAE 100 R2AT
ISO 1436 2SN/R2AT

Tube: oil resistant synthetic rubber.

Reinforcement: two high tensile steel braid (2B).

Cover: abrasion, ozone and hydrocarbon resistant synthetic rubber.

Application: high pressure hydraulic lines, fuel oil, antifreeze solutions, air and water. Specially designed for high temperature applications.

Continuous service temperature range:

-40 °C +150 °C (-40 °F +300 °F)

Air max T = +110 °C (+230 °F)

Length: random up to 1" - 40m / 61m max for 1 1/4" and over

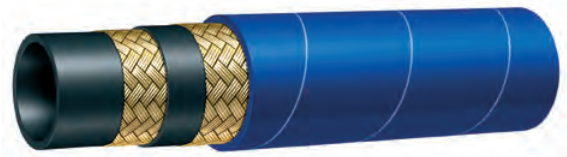

Dash	↔		↔		⊕		⊕		⌒		Ⓜ	
	mm	in	mm	in	Mpa	psi	Mpa	psi	mm	in	kg/m	lb/C ft
-04	6	1/4	15	0.59	40	5800	160	23200	100	4	0.36	24
-06	10	3/8	19.1	0.75	33	4800	132	19200	125	5	0.51	34
-08	13	1/2	22.2	0.87	28	4000	112	16000	175	7	0.64	43
-10	16	5/8	25.4	1	25	3630	100	14520	200	8	0.74	50
-12	19	3/4	29.3	1.15	21.5	3120	86	12480	240	9.6	0.91	61
-16	25	1	38.1	1.5	16.5	2400	66	9600	300	12	1.32	88
-20	32	1 1/4	48.3	1.9	12.5	1820	50	7280	420	16.8	1.93	129
-24	38	1 1/2	54.6	2.15	9	1310	36	5240	500	20	2.41	161
-32	51	2	67.4	2.65	8	1160	32	4640	630	25.2	2.96	198

OIL RETURN LINES



FLEXOR T604

SAE 100 R4

Tube: oil resistant synthetic rubber.
Reinforcement: high tensile textile cords with embedded steel helix wire.
Cover: abrasion, ozone and hydrocarbon resistant synthetic rubber.
Application: fuel, oil and hydraulic fluids suction and delivery with 50% max aromatic content. Specially designed for hydraulic oil return lines.
Continuous service temperature range:
 -40 °C +100 °C (-40 °F +212 °F)
Length: 61m max



↔			↔		⬇		⬆		⤵		⬆	
Dash	mm	in	mm	in	Mpa	psi	Mpa	psi	mm	in	kg/m	lb/C ft
-12	19	3/4	29	1.14	2.1	300	8.4	1200	57	2.24	0.60	40
-16	25	1	35	1.38	1.7	250	7.0	1000	75	2.95	0.74	50
-20	32	1 1/4	42	1.65	1.4	200	5.6	800	96	3.78	0.89	60
-24	38	1 1/2	48	1.89	1.0	150	4.2	600	114	4.49	1.03	69
-32	51	2	61	2.40	0.7	100	2.8	400	153	6.02	1.32	89
-40	64	2 1/2	75	2.95	0.4	62	1.7	250	189	7.44	2.07	139
-48	76	3	88	3.46	0.4	56	1.6	225	228	8.98	2.47	166
-56	90	3.1/2	104	4.09	0.3	45	1.3	180	270	10.63	3.04	204
-64	102	4	116	4.57	0.2	30	0.8	120	306	12.05	3.39	228

INDUSTRIAL HOSE

MINING - COMPRESSED AIR53

MINING - WATER & LIQUIDS55

MINING - CONCRETE56

MINING - ACID,
CHEMICAL & MULTIPURPOSE57

MINING - HYDROCARBONS58

MINING59

ALFAGOMMA - ITALY - HIGH PRESSURE USE - 20 BAR (300 PSI) AIR

ALFAGOMMA - ITALY - HIGH PRESSURE USE - 20 BAR (300 PSI) AIR





ALFAGOMMA - ITALY - T-202 10 BAR (150 PSI) GENERAL PURPOSE - EPDM

ALFAGOMMA - ITALY - T-202 10 BAR (150 PSI) GENERAL PURPOSE - EPDM



ALFAGOMMA - ITALY - T - 509 - 16 BAR (240 PSI) UHMWPE CHEMICAL S&D - 90°

VISUAL INDEX

MINING - COMPRESSED AIR

	185AA Compressed air 20 bar (300 psi) - standard duty - exceeds DIN 20018/1	53
	155AA Compressed air 20 bar (300 psi) - heavy duty	53
	155AK Compressed air 20 bar (300 psi) - heavy duty	54
	132AE Compressed air 80 bar (1200 psi) - high temperature - steel braided	54
	142AK Compressed air 40 bar (600 psi) - oil resistant - steel braided	54

MINING - WATER & LIQUIDS

	284AA Water delivery 10 bar (150 psi)	55
	288HH Water discharge - PVC - lay flat - heavy duty	55

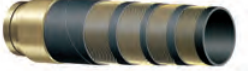

MINING - CONCRETE

	740AA Concrete pumping 85 bar (1275 psi) heavy duty - steel reinforced	56
---	--	-----------











MINING - ACID, CHEMICAL & MULTIPURPOSE

	202AA General purpose S&D 10 bar (150 psi) - EPDM	57
---	---	-----------

MINING - HYDROCARBONS









	605AA Fuel-oil S&D 10 bar (150 psi)	58
	658AA Domestic fuel reeling - Explosive handling 16 bar (240 psi) - textile braided - EN 1360 TRbf 131/2	58

MINING

	151AA Compressed air 20 bar (300 psi) - heavy duty mining	59
	151AK Compressed air 20 bar (300 psi) - heavy duty mining	59
	189AK Air-water delivery - PVC - FRAS - AS 2660/A AS/NZS 2554/A	59
	131AA Compressed air 70 bar (1000 psi) - steel reinforced - FRAS - exceeds AS 2660/B	60
	170AA Compressed air 100 bar (1500 psi) - steel braided	60
	289GG Mine dewatering - PVC - lay flat	60
	240AA Air-water delivery 20 bar (300 psi) - FRAS - exceeds AS 2660/B	61
	225AA General purpose S&D 10 bar (150 psi) - FRAS - exceeds AS 2660/C	61
	245AA General purpose delivery & light suction 27 bar (400 psi) - crush resistant FRAS - exceeds AS 2660/B	61
	756AA Gunitite 14 bar (200 psi) - FRAS - exceeds AS 2660/C	62

VISUAL INDEX

MINING







	765AA Stone dust 7 bar (100 psi) - FRAS - AS 2660/C	62
	707AA Abrasive slurry S&D 10 bar (150 psi) - muff couplings	62
	706AA Abrasive slurry S&D 10 bar (150 psi) - muff couplings	63
	776AA Mineral sampling 35 bar (525 psi)	63
	714HA Drill cuttings suction 5 bar (75 psi) - corrugated - AS 2187/2	63
	660AA Nitro blast loading - AS 2187-2	64
	612AA Nitro blast handling 20 bar (300 psi)	64
	964AA Cable protection - FRAS - AS 1802 AS 2660	64

185AA

Compressed air 20 bar (300 psi)
standard duty
exceeds DIN 20018/1



Tube: Black synthetic elastomer - oil mist resistant
Reinforcement: High tensile textile cords
Cover: Black synthetic elastomer with longitudinal yellow stripes
 abrasion and ozone resistant
Use: Compressed air and general industrial applications
Safety factor: 3:1
Temperature: -10 °C +60 °C (+14 °F +140 °F)







										
mm	inch	mm	inch	bar	psi	mm	inch	%	kg/m	lb/ft
6	1/4	13	0.51	20	300	48	2.00		0.145	0.097
8	5/16	15	0.59	20	300	64	2.50		0.175	0.118
10	3/8	17	0.67	20	300	80	3.00		0.205	0.138
13	1/2	21	0.83	20	300	104	4.00		0.300	0.200
16	5/8	25	0.98	20	300	128	5.00		0.395	0.265
19	3/4	29	1.14	20	300	152	6.00		0.465	0.350
25	1	36	1.42	20	300	200	8.00		0.640	0.480

155AA

Compressed air 20 bar (300 psi)
heavy duty



Tube: Black SBR/NBR - oil mist resistant
Reinforcement: High tensile textile cords
Cover: Black SBR - abrasion and ozone resistant
Use: Compressed air designed for heavy duty applications
Safety factor: <= 51 mm 3:1 >= 55 mm 2.5:1
Temperature: -30 °C +80 °C (-22 °F +176 °F)

										
mm	inch	mm	inch	bar	psi	mm	inch	%	kg/m	lb/ft
19	3/4	29	1.14	20	300				0.540	0.360
22	7/8	32	1.26	20	300				0.610	0.410
25	1	35	1.38	20	300				0.680	0.460
28	1 1/8	38	1.50	20	300				0.780	0.520
30	1 3/16	42	1.65	20	300				1.010	0.680
32	1 1/4	44	1.73	20	300				1.060	0.710
35	1 3/8	47	1.85	20	300				1.140	0.770
38	1 1/2	50	1.97	20	300				1.240	0.830
40	1 9/16	52	2.05	20	300				1.290	0.870
45	1 3/4	57	2.24	20	300				1.440	0.970
48	1 7/8	60	2.36	20	300				1.260	0.850
51	2	63	2.48	20	300				1.330	0.890
51	2	65	2.56	20	300				1.630	1.100
55	2 1/6	69	2.72	20	300				1.730	1.160
60	2 3/8	76	2.99	20	300				2.160	1.450
63	2 1/2	79	3.11	20	300				2.250	1.510
76	3	92	3.62	20	300				2.750	1.850
90	3 1/2	106	4.17	20	300				3.180	2.140
102	4	118	4.65	20	300				3.600	2.420
152	6	170	6.69	20	300				6.100	4.100

MINING - COMPRESSED AIR



155AK

**Compressed air 20 bar (300 psi)
heavy duty**



Tube: Black SBR/NBR - oil mist resistant
Reinforcement: High tensile textile cords
Cover: Yellow SBR - abrasion and ozone resistant
Use: Compressed air designed for heavy duty applications
Safety factor: <= 51 mm 3:1 >=63 mm 2.5:1
Temperature: -30 °C +80 °C (-22 °F +176 °F)

↔		↔		⌚		⌒		⌘	⌚	
mm	inch	mm	inch	bar	psi	mm	inch	%	kg/m	lb/ft
13	1/2	21	0.83	20	300				0.320	0.215
19	3/4	29	1.14	20	300				0.560	0.380
25	1	35	1.38	20	300				0.700	0.470
32	1 1/4	44	1.73	20	300				1.090	0.730
38	1 1/2	50	1.97	20	300				1.260	0.850
51	2	65	2.56	20	300				1.660	1.120
63	2 1/2	79	3.11	20	300				2.300	1.550
76	3	92	3.62	20	300				2.810	1.890
102	4	118	4.65	20	300				3.670	2.470

132AE

**Compressed air 80 bar (1200 psi)
high temperature - steel braided**

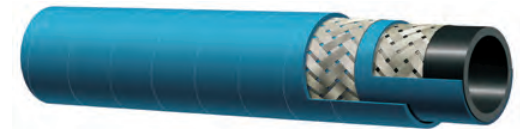

Tube: Black chlorobutyl - oil mist and high temperature resistant
Reinforcement: High tensile steel wire braids
Cover: Blue EPDM - abrasion and ozone resistant - pin pricked
Use: High pressure compressed air designed for heavy duty mine and quarry applications where long service life and maximum safety is required. Designed for use of EN 853 2ST fittings
Safety factor: 4:1
Temperature: -40 °C +150 °C (-40 °F +300 °F) with peaks of 232 °C (450 °F)

↔		↔		⌚		⌒		⌘	⌚	
mm	inch	mm	inch	bar	psi	mm	inch	%	kg/m	lb/ft
51	2	70	2.76	80	1200	255	10.00		3.100	2.080

142AK

**Compressed air 40 bar (600 psi)
high temperature - steel braided**



Tube: black nbr (rma class a) - oil mist resistant
Reinforcement: high tensile steel wire braids
Cover: yellow sbr/nbr - abrasion, ozone, hydrocarbon and flame resistant - pin pricked
Temperature: -40°C +120°C (-40°F +242°F)
Maximum working pressure: 40 bar
Minimum burst pressure: 160 bar

↔		↔		⌚		⌒		⌘	⌚	
mm	inch	mm	inch	bar	psi	mm	inch	%	kg/m	lb/ft
51	2	64	2.52	40	600	255	10.00		2.050	1.373
63	2 1/2	79	3.11	40	600	315	12.50		2.850	1.909
76	3	92	3.62	40	600	380	15.00		3.520	2.357

284AA

Water delivery 10 bar (150 psi)

Tube: Black synthetic elastomer - oil mist resistant

Reinforcement: High tensile textile cords

Cover: Black synthetic elastomer with longitudinal green stripes
abrasion and ozone resistant

Use: Air and water delivery

Safety factor: 3:1

Temperature: -10 °C +60 °C (+14 °F +140 °F)



mm	inch	mm	inch	bar	psi	mm	inch	%	kg/m	lb/ft
10	3/8	17	0.67	10	150	80	3.00		0.205	0.138
13	1/2	19	0.75	10	150	104	4.00		0.205	0.138
16	5/8	23	0.91	10	150	128	5.00		0.295	0.200
19	3/4	26	1.02	10	150	152	6.00		0.345	0.230
22	7/8	30	1.18	10	150	176	7.00		0.455	0.310
25	1	33	1.30	10	150	200	8.00		0.510	0.340
32	1 1/4	44	1.73	7	100	256	10.00		0.955	0.640

288HH

Water discharge - PVC - lay flat - heavy duty

Tube: Red PVC

Reinforcement: High tensile textile cords

Cover: Red PVC - abrasion and ozone resistant

Use: Lay flat water discharge

Safety factor: 3:1

Temperature: -10 °C +60 °C (+14 °F +140 °F)



mm	inch	mm	inch	bar	psi	mm	inch	%	kg/m	lb/ft
25	1			10	150				0.190	0.128
32	1 1/4			9	135				0.240	0.160
38	1 1/2			8	120				0.300	0.200
45	1 3/4			8	120				0.350	0.235
51	2			8	120				0.410	0.275
63	2 1/2			8	120				0.560	0.380
76	3			8	120				0.680	0.460
102	4			7	100				1.000	0.670
152	6			4	60				1.650	1.110

MINING - CONCRETE



740AA

**Concrete pumping 85 bar (1275 psi)
heavy duty - steel reinforced**

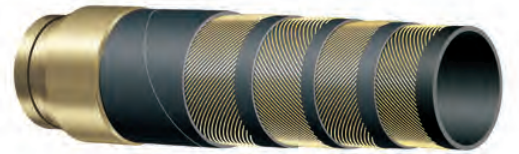

Tube: Black conductive NR - abrasion resistant
Reinforcement: High tensile steel cords
Cover: Black conductive SBR/NR - abrasion and ozone resistant
Use: High pressure concrete pumping
Safety factor: 2:1
Temperature: -30 °C +80 °C (-22 °F +176 °F)

mm	inch	mm	inch	bar	psi	mm	inch	%	kg/m	lb/ft
51	2	69	2.72	85	1275	255	10.00		2.160	1.450
63	2 1/2	85	3.35	85	1275	265	10.50		3.380	2.270
76	3	100	3.94	85	1275	380	15.00		4.590	3.080
90	3 1/2	116	4.57	85	1275	450	17.50		5.930	3.990
102	4	128	5.04	85	1275	510	20.00		7.510	5.050
127	5	155	6.10	85	1275	635	25.00		10.940	7.350

202AA

General purpose S&D 10 bar (150 psi) - EPDM



Tube: Black EPDM







Reinforcement: High tensile textile cords with embedded steel helix wire

Cover: Black EPDM - abrasion and ozone resistant

Use: Water suction and delivery. Also suitable for mild chemicals and fertilizers in general industrial and agricultural applications

Safety factor: <= 127 mm 3:1 >=152 mm 2.5:1

Temperature: -30 °C +80 °C (-22 °F +176 °F)

										
mm	inch	mm	inch	bar	psi	mm	inch	%	kg/m	lb/ft
25	1	35	1.38	10	150	100	4.00	100	0.700	0.460
30	1 3/16	40	1.57	10	150	120	4.75	100	0.780	0.520
32	1 1/4	42	1.65	10	150	128	5.00	100	0.820	0.540
38	1 1/2	48	1.89	10	150	152	6.00	100	0.960	0.630
40	1 9/16	50	1.97	10	150	160	6.25	100	1.000	0.670
45	1 3/4	55	2.17	10	150	180	7.00	100	1.110	0.750
51	2	61	2.40	10	150	204	8.00	100	1.240	0.820
60	2 3/8	72	2.83	10	150	240	9.50	100	1.710	1.180
63	2 1/2	75	2.95	10	150	252	10.00	90	1.780	1.180
70	2 3/4	82	3.23	10	150	280	11.00	90	1.990	1.340
76	3	88	3.46	10	150	304	12.00	90	2.140	1.410
80	3 1/8	92	3.62	10	150	320	12.50	90	2.300	1.550
90	3 1/2	102	4.02	10	150	360	14.00	90	2.700	1.770
102	4	114	4.49	10	150	408	16.00	90	3.010	1.980
110	4 5/16	122	4.80	10	150	440	17.25	80	3.210	2.160
115	4 1/2	127	5.00	10	150	460	18.00	80	3.340	2.240
120	4 3/4	134	5.28	10	150	600	23.75	80	4.500	3.020
127	5	141	5.55	10	150	635	25.00	80	4.740	3.140
152	6	166	6.54	10	150	760	30.00	80	5.970	3.920
203	8	221	8.70	10	150	1015	40.00	70	9.830	6.590
254	10	272	10.71	10	150	1270	50.00	60	13.430	9.030
305	12	327	12.87	10	150	1550	61.00	60	18.660	12.540

MINING - HYDROCARBONS



605AA

Fuel-oil S&D 10 bar (150 psi)



Tube: Black conductive NBR

Reinforcement: High tensile textile cords with embedded steel helix wire

Cover: Black CR - abrasion, ozone and hydrocarbon resistant

Use: Fuel and oil suction and delivery. Specially designed for tank truck and general industrial applications

Safety factor: <= 127 mm 3:1 133-254 mm 2.5:1 305 mm 1.5:1

Temperature: -30 °C +80 °C (-22 °F +176 °F)

↔		↔		Ⓜ		⌒		⌘	Ⓜ	
mm	inch	mm	inch	bar	psi	mm	inch	%	kg/m	lb/ft
19	3/4	29	1.14	10	150	76	3.00	100	0.600	0.400
25	1	35	1.38	10	150	100	4.00	100	0.740	0.500
28	1 1/8	38	1.50	10	150	112	4.50	100	0.810	0.540
30	1 3/16	40	1.57	10	150	120	4.75	100	0.840	0.560
32	1 1/4	42	1.65	10	150	128	5.00	100	0.900	0.600
35	1 3/8	45	1.77	10	150	140	5.50	100	0.960	0.650
38	1 1/2	48	1.89	10	150	152	6.00	100	1.030	0.690
40	1 9/16	50	1.97	10	150	160	6.25	100	1.070	0.720
42	1 5/8	52	2.05	10	150	168	6.75	100	1.120	0.750
45	1 3/4	55	2.17	10	150	180	7.00	100	1.190	0.800
48	1 7/8	58	2.28	10	150	192	7.50	100	1.260	0.850
51	2	61	2.40	10	150	204	8.00	100	1.330	0.890
57	2 1/4	67	2.64	10	150	228	9.00	100	1.460	0.980
60	2 3/8	72	2.83	10	150	240	9.50	100	1.990	1.340
63	2 1/2	75	2.95	10	150	252	10.00	90	2.080	1.400
70	2 3/4	82	3.23	10	150	280	11.00	90	2.300	1.550
76	3	88	3.46	10	150	304	12.00	90	2.480	1.670
80	3 1/8	94	3.70	10	150	320	12.50	90	2.660	1.790
90	3 1/2	104	4.09	10	150	360	14.00	90	3.040	2.040
102	4	116	4.57	10	150	408	16.00	90	3.400	2.280
110	4 5/16	124	4.88	10	150	440	17.25	90	4.160	2.800
115	4 1/2	129	5.08	10	150	460	18.00	90	4.330	2.910
120	4 3/4	138	5.43	10	150	480	19.00	80	5.490	3.690
127	5	145	5.71	10	150	508	20.00	80	5.780	3.880
133	5 1/4	151	5.94	10	150	532	21.00	80	6.030	4.050
152	6	170	6.69	10	150	608	24.00	80	7.150	4.810
203	8	225	8.86	10	150	812	32.00	70	11.630	7.820

658AA

Domestic fuel reeling - Explosive handling 16 bar (240 psi) - textile braided EN 1360 TRbf 131/2



Tube: Black conductive NBR

Reinforcement: High tensile textile braids

Cover: Black conductive CR - abrasion, ozone, hydrocarbon and fire resistant

Use: Fuel and oil delivery in heavy duty reeling applications.

Also suitable for tank cleaning.

Antistatic wire available on request

Safety factor: 3:1

Temperature: -30 °C +70 °C (-22 °F +158 °F)

↔		↔		Ⓜ		⌒		⌘	Ⓜ	
mm	inch	mm	inch	bar	psi	mm	inch	%	kg/m	lb/ft
32	1 1/4	44	1.73	16	240	160	6.25		0.970	0.650
35	1 3/8	47	1.85	16	240	175	7.00		1.040	0.700
38	1 1/2	51	2.01	16	240	190	7.50		1.130	0.760
40	1 9/16	53	2.09	16	240	200	8.00		1.180	0.790
51	2	67	2.64	16	240	255	10.00		1.650	1.110

151AA

**Compressed air 20 bar (300 psi)
heavy duty mining**



Tube: Black SBR/NBR - oil mist resistant
Reinforcement: High tensile textile cords
Cover: Black SBR - abrasion and ozone resistant
Use: Compressed air designed for heavy duty mining applications
Safety factor: 3:1
Temperature: -30 °C +80 °C (-22 °F +176 °F)

↔		↔		⚡		⤴		⌋	⚖	
mm	inch	mm	inch	bar	psi	mm	inch	%	kg/m	lb/ft
13	1/2	23	0.91	20	300				0.420	0.280
19	3/4	31	1.22	20	300				0.680	0.460
25	1	37	1.46	20	300				0.840	0.560
38	1 1/2	52	2.05	20	300				1.240	0.830
51	2	67	2.64	20	300				2.160	1.450
76	3	93	3.66	20	300				3.190	2.140

151AK

**Compressed air 20 bar (300 psi)
heavy duty mining**



Tube: Black SBR/NBR - oil mist resistant
Reinforcement: High tensile textile cords
Cover: Yellow SBR - abrasion and ozone resistant
Use: Compressed air designed for heavy duty mining applications
Safety factor: 3:1
Temperature: -30 °C +80 °C (-22 °F +176 °F)

↔		↔		⚡		⤴		⌋	⚖	
mm	inch	mm	inch	bar	psi	mm	inch	%	kg/m	lb/ft
13	1/2	23	0.91	20	300				0.430	0.290
19	3/4	31	1.22	20	300				0.700	0.470
25	1	37	1.46	20	300				0.860	0.580
38	1 1/2	52	2.05	20	300				1.260	0.850
51	2	67	2.64	20	300				2.210	1.490

189AK

**Air-water delivery - PVC - FRAS
AS 2660/A AS/NZS 2554/A**

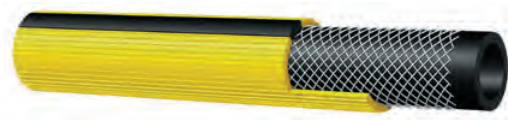

Tube: Black antistatic PVC
Reinforcement: High tensile textile cords
Cover: Yellow ribbed PVC with longitudinal antistatic stripes-abrasion and ozone resistant
Use: Compressed air in underground mining applications. Specially designed for roof bolting applications
Safety factor: ≤ 19 mm 3.5:1 25 mm 2:1
Temperature: -5 °C +60 °C (-23 °F +140 °F)

↔		↔		⚡		⤴		⌋	⚖	
mm	inch	mm	inch	bar	psi	mm	inch	%	kg/m	lb/ft
13	1/2	21	0.83	20	300	104	4.00		0.270	0.180
19	3/4	29	1.14	20	300	152	6.00		0.485	0.330
25	1	35	1.38	35	525	200	8.00		0.565	0.380

MINING



131AA

**Compressed air 70 bar (1000 psi)
steel reinforced - FRAS
exceeds AS 2660/B**



Tube: Black SBR/NBR-oil mist resistant
Reinforcement: High tensile steel cords
Cover: Black conductive SBR - abrasion, ozone and fire resistant
Use: High pressure compressed air and water in heavy duty "long wall" mining where long service life and maximum safety is required
Safety factor: 3:1
Temperature: -30 °C +80 °C (-22 °F +176 °F)

mm	inch	mm	inch	bar	psi	mm	inch		%	kg/m
38	1 1/2	52	2.05	70	1000	190	7.50		1.460	0.980
51	2	65	2.56	70	1000	255	10.00		2.180	1.470
63	2 1/2	83	3.27	70	1000	315	12.50		3.820	2.570
76	3	96	3.78	40	600	380	15.00		3.500	2.350
102	4	122	4.80	40	600	510	20.00		5.200	3.490

170AA

**Compressed air 100 bar (1500 psi)
steel braided**



Tube: Black NBR
Reinforcement: High tensile steel braids
Cover: Black CR/SBR - abrasion, ozone and hydrocarbon resistant
Use: Heavy duty high pressure compressed air. Specially designed for mobile drilling rigs
Safety factor: 4:1
Temperature: -40 °C +90 °C (-40 °F +200 °F)

mm	inch	mm	inch	bar	psi	mm	inch		%	kg/m
63	2 1/2	86	3.39	100	1500	760	30.00		5.230	3.510
63	2 1/2	93	3.66	100	1500	760	30.00		6.650	4.470
76	3	100	3.94	100	1500	910	36.00		6.700	4.500
76	3	105	4.13	100	1500	910	36.00		7.780	5.230

289GG

Mine dewatering - PVC - lay flat



Tube: Green PVC
Reinforcement: High tensile textile cords
Cover: Green PVC - abrasion, ozone and cut resistant
Use: Lay flat water discharge for heavy duty applications. Specially designed for mine and construction sites dewatering. High end load resistance
Safety factor: 4:1
Temperature: -10 °C +60 °C (+14 °F +140 °F)

mm	inch	mm	inch	bar	psi	mm	inch		%	kg/m
105	4	113	4.45	14	200				1.740	1.170
157	6	167	6.57	10	150				3.300	2.220
208	8	220	8.66	10	150				5.140	3.450

240AA

Air-water delivery 20 bar (300 psi) - FRAS exceeds AS 2660/B



Tube: Black conductive SBR/NR

Reinforcement: High tensile textile cords

Cover: Black conductive SBR - abrasion, ozone and fire resistant

Use: Air, water and stone dust delivery in underground mines

Safety factor: <= 63 mm 4:1 76 mm-102 mm 3,5:1

Temperature: -30 °C +80 °C (-22 °F +176 °F)

mm	inch	mm	inch	bar	psi	mm	inch	%	kg/m	lb/ft
13	1/2	23	0.91	20	300				0.320	0.215
19	3/4	31	1.22	20	300				0.530	0.360
25	1	37	1.46	20	300				0.670	0.450
32	1 1/4	46	1.81	20	300				1.020	0.690
38	1 1/2	52	2.05	20	300				1.160	0.780
51	2	67	2.64	20	300				1.740	1.170
63	2 1/2	80	3.15	20	300				2.150	1.440
76	3	93	3.66	20	300				2.550	1.710
102	4	119	4.69	20	300				3.420	2.300

225AA

General purpose S&D 10 bar (150 psi) - FRAS exceeds AS 2660/C

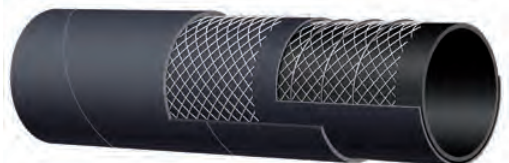

Tube: Black conductive SBR/NR

Reinforcement: High tensile textile cords with embedded steel helix wire

Cover: Black conductive SBR - abrasion, ozone and fire resistant

Use: Water and stone dust suction and delivery.

Also suitable for methane drainage/extraction in underground coal mines

Safety factor: 4:1

Temperature: -30 °C +80 °C (-22 °F +176 °F)

mm	inch	mm	inch	bar	psi	mm	inch	%	kg/m	lb/ft
51	2	61	2.40	10	150	204	8.00	100	1.200	0.810
63	2 1/2	75	2.95	10	150	252	10.00	90	1.920	1.290
76	3	88	3.46	10	150	304	12.00	90	2.280	1.530
102	4	116	4.57	10	150	408	16.00	90	3.520	2.370
152	6	170	6.69	10	150	760	30.00	80	6.650	4.470

245AA

General purpose delivery & light suction 27 bar (400 psi) - crush resistant - FRAS exceeds AS 2660/B



Tube: Black conductive SBR/NR

Reinforcement: High tensile textile braids

Cover: Black conductive SBR - abrasion, ozone and fire resistant

Use: Air and water delivery - light suction.

Special heavy wall braided construction for vacuum, crush and kink resistance.

Ideal for methane drainage/extraction in underground coal mines.

Vacuum resistance 60%

Safety factor: 3:1

Temperature: -30 °C +80 °C (-22 °F +176 °F)

mm	inch	mm	inch	bar	psi	mm	inch	%	kg/m	lb/ft
51	2	73	2.87	27	400			60	2.370	1.590

MINING



756AA

Gunite 14 bar (200 psi) - FRAS exceeds AS 2660/C



Tube: Black conductive NR - abrasion resistant
Reinforcement: High tensile textile cords
Cover: Black conductive SBR - abrasion, ozone and fire resistant
Use: Gunite
Safety factor: 4:1
Temperature: -30 °C +80 °C (-22 °F +176 °F)

mm	inch	mm	inch	bar	psi	mm	inch	%	kg/m	lb/ft
38	1 1/2	62	2.44	14	200				2.230	1.500
51	2	75	2.95	14	200				2.850	1.920

765AA

Stone dust 7 bar (100 psi) - FRAS AS 2660/C



Tube: Black conductive SBR/NR - abrasion resistant
Reinforcement: High tensile textile cords
Cover: Black conductive SBR - abrasion, ozone and fire resistant
Use: "Stone dusting" in underground mines.
 Also suitable for air and water delivery
Safety factor: 4:1
Temperature: -30 °C +80 °C (-22 °F +176 °F)

mm	inch	mm	inch	bar	psi	mm	inch	%	kg/m	lb/ft
32	1 1/4	46	1.81	7	100				0.940	0.630
38	1 1/2	52	2.05	7	100				1.090	0.730
51	2	65	2.56	7	100				1.430	0.960

707AA

Abrasive slurry S&D 10 bar (150 psi) muff couplings

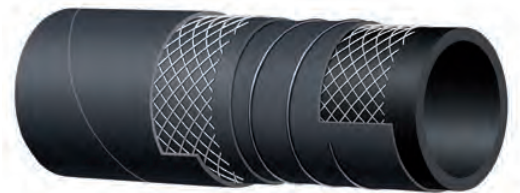

Tube: Black conductive NR
 Abrasion resistance 50 mm³ (ISO 4649/A)
Reinforcement: High tensile textile cords with embedded steel helix wire
Cover: Black conductive SBR/NR - abrasion and ozone resistant
Use: Bulk material and abrasive slurries suction and delivery in heavy duty mining. Designed for muff coupling use
Safety factor: <= 127 mm 3:1 >152 mm 2.5:1
Temperature: -30 °C +80 °C (-22 °F +176 °F)

mm	inch	mm	inch	bar	psi	mm	inch	%	kg/m	lb/ft
51	2	69	2.72	10	150	204	8.00	90	2.190	1.470
76	3	98	3.86	10	150	304	12.00	90	4.040	2.720
102	4	124	4.88	10	150	408	16.00	90	5.400	3.630
127	5	153	6.02	10	150	635	25.00	80	7.350	4.940
152	6	178	7.01	10	150	760	30.00	80	9.360	6.290
203	8	237	9.33	10	150	1015	40.00	70	17.320	11.640
254	10	292	11.50	10	150	1270	50.00	70	23.720	15.940

706AA

Abrasive slurry S&D 10 bar (150 psi) muff couplings

Tube: Black conductive NR

Abrasion resistance 50 mm³ (ISO 4649/A)

Reinforcement: High tensile textile cords with embedded steel helix wire

Cover: Black conductive SBR/NR - abrasion and ozone resistant

Use: Bulk material and abrasive slurries suction and delivery in heavy duty mining. Designed for muff coupling use

Safety factor: ≤ 127 mm 3:1 >152 mm 2.5:1

Temperature: -30 °C +80 °C (-22 °F +176 °F)

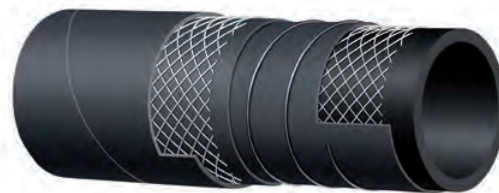

↔		↔		⊕		⌒		⌒		⌒	
mm	inch	mm	inch	bar	psi	mm	inch	%	kg/m	lb/ft	
76	3	102	4.02	10	150	304	12.00	90	4.770	3.210	
102	4	128	5.04	10	150	408	16.00	90	6.310	4.240	
127	5	159	6.26	10	150	635	25.00	80	9.440	6.340	
152	6	184	7.24	10	150	760	30.00	80	11.420	7.670	
203	8	235	9.25	10	150	1015	40.00	70	15.480	10.400	
254	10	286	11.26	10	150	1270	50.00	60	21.600	14.520	
300	12	344	13.54	10	150	1500	60.00	60	34.490	23.180	

776AA

Mineral sampling 35 bar (525 psi)

Tube: Black conductive NR - abrasion resistant

Reinforcement: High tensile textile cords with embedded steel helix wire

Cover: Black conductive SBR/NR - abrasion and ozone resistant

Use: Mineral recovery in sampling operations

Safety factor: 3:1

Temperature: -30 °C +80 °C (-22 °F +176 °F)



↔		↔		⊕		⌒		⌒		⌒	
mm	inch	mm	inch	bar	psi	mm	inch	%	kg/m	lb/ft	
51	2	77	3.03	35	525	204	8.00	100	3.070	2.060	
76	3	106	4.17	35	525	304	12.00	90	5.000	3.360	
102	4	134	5.28	35	525	408	16.00	90	7.290	4.900	

714HA

Drill cutting suction 5 bar (75 psi) - corrugated

Tube: Red NR - abrasion resistant

Reinforcement: High tensile textile cords with embedded steel helix wire antistatic wire

Cover: Black conductive SBR/NR - abrasion and ozone resistant

Use: Bulk material suction and delivery.

Specially designed for drill cutting suction in mobile drilling rigs.

Corrugated construction for maximum flexibility

Safety factor: 3:1

Temperature: -30 °C +80 °C (-22 °F +176 °F)



↔		↔		⊕		⌒		⌒		⌒	
mm	inch	mm	inch	bar	psi	mm	inch	%	kg/m	lb/ft	
51	2	61	2.5	5	75	204	8	90	1.183	0.225	
63	2.5	75	3	5	75	252	10	90	1.848	1.240	
76	3	90	3.5	5	75	304	12	90	2.551	1.710	
102	4	116	4.5	5	75	408	16	90	3.568	2.400	
115	4.5	129	5	5	75	460	18	90	4.058	2.730	
127	5	141	5.5	5	75	635	25	90	4.695	3.160	
152	6	166	6.5	5	75	760	30	90	5.567	3.740	

MINING



660AA

**Nitro blast loading
AS 2187-2**



Tube: Black conductive NBR - abrasion resistant
Reinforcement: High tensile textile fabric
Cover: Black conductive CR - abrasion, ozone, hydrocarbon and fire resistant
Use: Explosive loading in blasting holes
Temperature: -30 °C +80 °C (-22 °F +176 °F)

mm	inch	mm	inch	bar	psi	mm	inch	%	kg/m	lb/ft
19	3/4	25	0.98						0.200	0.135

612AA

Nitro blast handling 20 bar (300 psi)

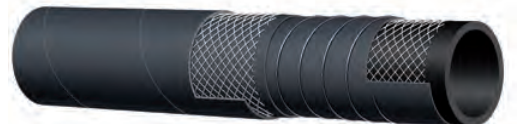

Tube: Black conductive NBR - abrasion resistant
Reinforcement: High tensile textile cords with embedded steel helix wire
Cover: Black conductive CR - abrasion, ozone, hydrocarbon and fire resistant
Use: Explosive handling in mobile delivery units. Specially designed for heavy duty reeling applications
Safety factor: 3:1
Temperature: -30 °C +80 °C (-22 °F +176 °F)

mm	inch	mm	inch	bar	psi	mm	inch	%	kg/m	lb/ft
51	2	71	2.80	20	300	255	10.00	70	2.840	1.910
63	2 1/2	83	3.27	20	300	315	12.50	70	3.320	2.230

964AA

**Cable protection - FRAS
AS 1802 AS 2660**



**NSW dept. of mineral resources
approved**

Tube: Black conductive SBR/NR
Reinforcement: High tensile textile cords
Cover: Black conductive SBR - abrasion, ozone and fire resistant
Use: Cable protection in underground mines. Also suitable for light duty air and water delivery max 5 bar (75 psi)
Safety factor: 3:1
Temperature: -30 °C +80 °C (-22 °F +176 °F)

mm	inch	mm	inch	bar	psi	mm	inch	%	kg/m	lb/ft
13	1/2	21	0.83	5	75				0.250	0.170
16	5/8	24	0.94	5	75				0.290	0.195
19	3/4	29	1.14	5	75				0.420	0.280
25	1	35	1.38	5	75				0.520	0.350
32	1 1/4	42	1.65	5	75				0.650	0.440
38	1 1/2	48	1.89	5	75				0.750	0.50
45	1 3/4	55	2.17	5	75				0.870	0.580
51	2	61	2.4	5	75				0.980	0.660

FERRULES

FERRULE SELECTION CHART.....66

STANDARD FERRULES.....70

INTERLOCK FERRULES.....74



FERRULE SELECTION CHART



H1100104 Page 70	H1100204 Page 70	H1200101 Page 71	H1200102 Page 71	H1200103 Page 71	H1200202 Page 72	H1200212 Page 72	H1200203 Page 72	H1200204 Page 73
-------------------------	-------------------------	-------------------------	-------------------------	-------------------------	-------------------------	-------------------------	-------------------------	-------------------------

NO SKIVE FERRULE FOR STANDARD INSERTS

HOSE TYPE	-03	-04	-05	-06	-08	-10	-12	-16	-20	-24	-32	-40	-48
	DN 05	DN 06	DN 08	DN 10	DN 12	DN 16	DN 19	DN 25	DN 31	DN 38	DN 52	DN 63	DN 76
	3/16"	1/4"	5/16"	3/8"	1/2"	5/8"	3/4"	1"	1 1/4"	1 1/2"	2"	2 1/2"	3"
FLEXOR 6		H1100204	H1100204	H1100204	H1100204	H1100204	H1100204	H1100204					
FLEXOR 3		H1200203	H1200203	H1200203	H1200203	H1200203	H1200203	H1200203	H1200203				
FLEXOPAK 1SC		H1200101	H1200101	H1200101	H1200101	H1200202	H1200202	H1200103	H1200102	H1200202	H1200202		
FLEXOR 1SN MSHA	H1200203	H1200102	H1200202	H1200212	H1200212	H1200202	H1200202	H1200202	H1200102	H1200202	H1200202	H1200203	C122...-48
FLEXOPAK 2SC		H1200102	H1200202	H1200212	H1200212	H1200202	H1200202	H1200202					
FLEXOR 2SN MSHA	H1200203	H1200202	H1200202	H1200212	H1200212	H1200202	H1200202	H1200202	H1200202	H1200202	H1200202		
FLEXOR 12				H1200204	H1200204	H1200204	H1200204	H1200204	H1200204				
AT3K-1B/2B		H1200101	H1200101	H1200101	H1200101	H1200202	H1200202	H1200202					
AT4K-2B			H1200202	H1200212	H1200212	H1200202							
AT4K-4S				H1200204	H1200204	H1200204	H1200204	H1200204					
AT5K-2B		H1200102	H1200202	H1200212									
FLEXOR R4							H1200203	H1200203	H1200203	H1200203	H1200203	H1200203	

HOSE TYPE	-04	-05	-06	-08	-10	-12	-16	-20	-24	-32			
	DN 05	DN 06	DN 08	DN 10	DN 12	DN 16	DN 22	DN 29	DN 35	DN 46			
	3/16"	1/4"	5/16"	13/32"	1/2"	5/8"	7/8"	1 1/8"	1 3/8"	1 13/16"			
FLEXOR R5	H1200203 -03	H1200203 -04	H1200203 -05	H1200203 -06	H1200203 -08	H1200203 -10	H1200203 -12	H1200203 -16	H1200203 -20	H1100104 -32			

FERRULES - STANDARD

HYDRAULIC
HOSE

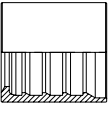

H1100104
Standard Ferrule

70

INDUSTRIAL
HOSE

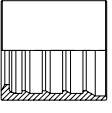

H1100204
Standard Ferrule

70

FERRULES

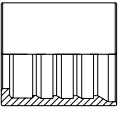

H1100404
Standard Ferrule

70

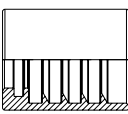

H1200101
Standard Ferrule

71

INSERTS

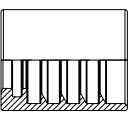

H1200102
Standard Ferrule

71

ADAPTERS

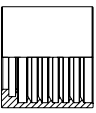

H1200103
Standard Ferrule

71

ACCESSORIES

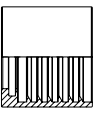

H1200202
Standard Ferrule

72

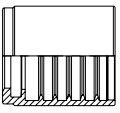

H1200212
Standard Ferrule

72

BALL VALVES

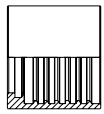

H1200203
Standard Ferrule

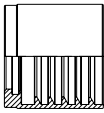

72



H1200204
Standard Ferrule

73

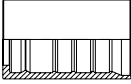
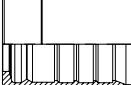
FERRULES - INTERLOCK

	<p>H1400200 Interlock Ferrule</p>	<p>74</p>
	<p>H1400301 Interlock Ferrule</p>	<p>74</p>
	<p>H1T00600 Interlock Ferrule</p>	<p>74</p>

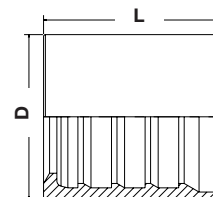
FERRULES - STANDARD**H1100104**
Standard Ferrule

PRODUCT CODE	TYPE	HOSE BORE			DIMENSIONS		HOSE TYPE
		DN	INCH	DASH	D mm	L mm	
H1100104-200000	STD	DN 31	1 1/4"	-20	50	43.7	1SN S
H1100104-240000	STD	DN 38	1 1/2"	-24	57	49.1	1SN S
H1100104-320000	STD	DN 51	2"	-32	71	63.6	1SN S - R5 NS

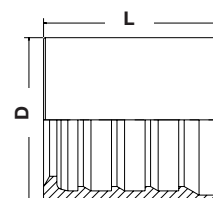
**H1100204**
Standard Ferrule

PRODUCT CODE	TYPE	HOSE BORE			DIMENSIONS		HOSE TYPE
		DN	INCH	DASH	D mm	L mm	
H1100204-040000	STD	DN 06	1/4"	-04	21	26.3	1SN/2SN/2SC/AJ400 S - R6/2TE NS
H1100204-050000	STD	DN 08	5/16"	-05	22	26.5	1SN/2SN/2SC/AT5K/AJ400 S - R6/2TE NS
H1100204-060000	STD	DN 10	3/8"	-06	25	28.5	1SN/2SN/2SC/AT5K/AJ400 S - R6/2TE NS
H1100204-080000	STD	DN 12	1/2"	-08	29	34.7	1SN/2SN/2SC/AT4K/AT5K/FXP3/AJ400 S - R6/2TE NS
H1100204-100000	STD	DN 16	5/8"	-10	32	37.5	1SN/2SN/2SC/AT3K/AT4K/R12/AT5K/FXP3 S - R6/2TE NS
H1100204-120000	STD	DN 19	3/4"	-12	36	41.5	1SN/2SN/2SC/AT3K/AT4K/R12/FXP3 S - R6/2TE NS
H1100204-160000	STD	DN 25	1"	-16	45	47.7	1SN/2SN/2SC/AT3K/AT4K/R12/4SP/FXP3 S - R6/2TE NS
H1100204-200000	STD	DN 31	1 1/4"	-20	58	54.6	2SN/AT3K/AT4K/R12 S
H1100204-240000	STD	DN 38	1 1/2"	-24	67	61.1	2SN/R12 S
H1100204-320000	STD	DN 51	2"	-32	82	75.1	2SN/R12 S

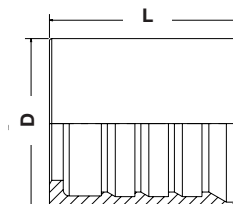
**H1100404**
Standard Ferrule

PRODUCT CODE	TYPE	HOSE BORE			DIMENSIONS		HOSE TYPE
		DN	INCH	DASH	D mm	L mm	
H1100404-040000	STD	DN 06	1/4"	-04	22	26.3	4SP/AT6K S
H1100404-060000	STD	DN 10	3/8"	-06	25	28.5	4SP/R12/AT4K/AT6K S
H1100404-080000	STD	DN 12	1/2"	-08	29	34.7	4SP/R12/AT4K/AT6K/FXP3 S
H1100404-100000	STD	DN 16	5/8"	-10	33	37.5	4SP/AT5K S
H1100404-120000	STD	DN 19	3/4"	-12	37	41.5	4SP/AT5K S



H1200101
Standard Ferrule

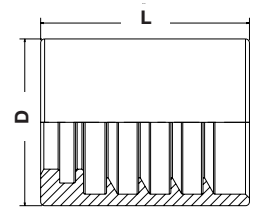

PRODUCT CODE	TYPE	HOSE BORE			DIMENSIONS		HOSE TYPE
		DN	INCH	DASH	D mm	L mm	
H1200101-040000	STD	DN 06	1/4"	-04	19	26.3	1SC/AT3K/AJ210 NS
H1200101-050000	STD	DN 08	5/16"	-05	21	26.3	1SC/AT3K/AJ210 NS
H1200101-060000	STD	DN 10	3/8"	-06	23	27.2	1SC/AT3K/AJ210 NS
H1200101-080000	STD	DN 12	1/2"	-08	27	32.8	1SC/AT3K/AJ210 NS



H1200102
Standard Ferrule

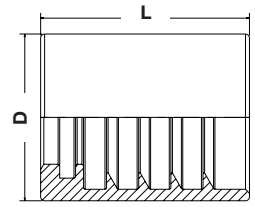

PRODUCT CODE	TYPE	HOSE BORE			DIMENSIONS		HOSE TYPE
		DN	INCH	DASH	D mm	L mm	
H1200102-040000	STD	DN 06	1/4"	-04	21	26.3	1SN/2SC/AT5K/FXP16/AJ400 NS
H1200102-200000	STD	DN 31	1 1/4"	-20	55	39.9	1SN/FXP16 NS

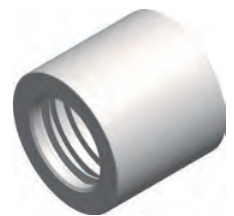

H1200103
Standard Ferrule

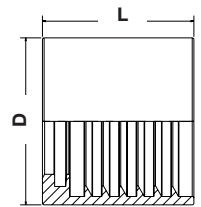

PRODUCT CODE	TYPE	HOSE BORE			DIMENSIONS		HOSE TYPE
		DN	INCH	DASH	D mm	L mm	
H1200103-040000	STD	DN 06	1/4"	-04	19	26.3	FXP PLT NS
H1200103-050000	STD	DN 08	5/16"	-05	21	26.3	FXP PLT NS
H1200103-060000	STD	DN 10	3/8"	-06	22	27.2	FXP PLT NS
H1200103-080000	STD	DN 12	1/2"	-08	25	32.8	FXP PLT NS
H1200103-160000	STD	DN 25	1"	-16	42	45.3	1SC NS

FERRULES - STANDARD

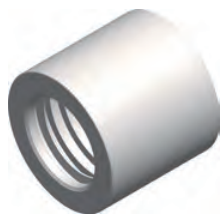

H1200202 Standard Ferrule

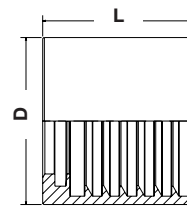

PRODUCT CODE	TYPE	HOSE BORE			DIMENSIONS		HOSE TYPE
		DN	INCH	DASH	D mm	L mm	
H1200202-040000	STD	DN 06	1/4"	-04	22	26.3	2SN NS
H1200202-050000	STD	DN 08	5/16"	-05	25	26.3	1SN/2SN/2SC/AT4K/AT5K/FXP16/AJ400 NS
H1200202-100000	STD	DN 16	5/8"	-10	34	35.6	1SN/2SN/1SC/AT3K/AT4K/FXP16 NS
H1200202-120000	STD	DN 19	3/4"	-12	38	38.6	1SN/2SN/1SC/2SC/AT3K/FXP16 NS
H1200202-160000	STD	DN 25	1"	-16	50	45.3	1SN/2SN/2SC/AT3K/FXP16 NS
H1200202-200000	STD	DN 31	1 1/4"	-20	61	50.2	2SN NS
H1200202-240000	STD	DN 38	1 1/2"	-24	70	63.7	1SN/2SN NS
H1200202-320000	STD	DN 51	2"	-32	82	73	1SN/2SN NS



H1200212 Standard Ferrule

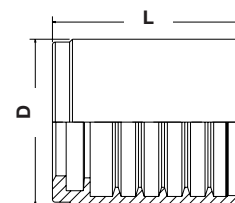

PRODUCT CODE	TYPE	HOSE BORE			DIMENSIONS		HOSE TYPE
		DN	INCH	DASH	D mm	L mm	
H1200212-060000	STD	DN 10	3/8"	-06	26	27.2	1SN/2SN/2SC/AT4K/AT5K/FXP16/AJ400 NS
H1200212-080000	STD	DN 12	1/2"	-08	29	32.8	1SN/2SN/2SC/AT4K/FXP16/AJ400 NS



H1200203 Standard Ferrule

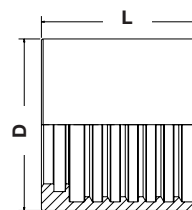

PRODUCT CODE	TYPE	HOSE BORE			DIMENSIONS		HOSE TYPE
		DN	INCH	DASH	D mm	L mm	
H1200203-030000	STD	DN 05	3/16"	-03	20	24.3	1SN/2SN/R5 NS - 1SN/2SN S
H1200203-040000	STD	DN 06	1/4"	-04	22	26.3	R3/3TE/R5 NS
H1200203-050000	STD	DN 08	5/16"	-05	25	26.3	R3/3TE/R5 NS
H1200203-060000	STD	DN 10	3/8"	-06	25	27.2	R3/3TE/R5 NS
H1200203-080000	STD	DN 12	1/2"	-08	29	32.8	R3/3TE/R5 NS
H1200203-100000	STD	DN 16	5/8"	-10	34	35.6	R3/3TE/R5 NS
H1200203-120000	STD	DN 19	3/4"	-12	38	38.6	R3/3TE/R4/R5 NS
H1200203-160000	STD	DN 25	1"	-16	50	45.3	R3/3TE/R4/R5 NS
H1200203-200000	STD	DN 31	1 1/4"	-20	51	49	R3/R4/R5 NS
H1200203-240000	STD	DN 38	1 1/2"	-24	60.3	56	R4/R5 NS
H1200203-320000	STD	DN 51	2"	-32	76.1	69	R4 NS
H1200203-400000	STD	DN 63	2 1/2"	-40	88.9	85	2ST/R4 NS



H1200204

Standard Ferrule

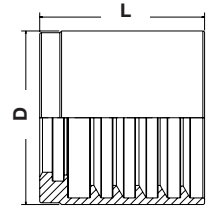

PRODUCT CODE	TYPE	HOSE BORE			DIMENSIONS		HOSE TYPE
		DN	INCH	DASH	D mm	L mm	
H1200204-060000	STD	DN 10	3/8"	-06	30	28	R12/AT4K NS
H1200204-080000	STD	DN 12	1/2"	-08	34	33.9	R12/AT4K NS
H1200204-100000	STD	DN 16	5/8"	-10	38	36.6	R12/AT4K NS
H1200204-120000	STD	DN 19	3/4"	-12	42	39.5	R12/AT4K NS
H1200204-160000	STD	DN 25	1"	-16	50	45.4	R12/AT4K NS
H1200204-200000	STD	DN 31	1 1/4"	-20	62	50.1	R12/AT3K NS

FERRULES - INTERLOCK

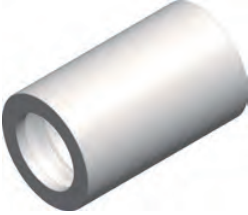

H1400200
Interlock Ferrule

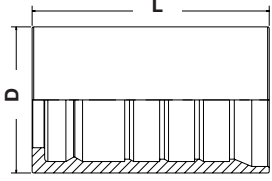

PRODUCT CODE	TYPE	HOSE BORE			DIMENSIONS		HOSE TYPE
		DN	INCH	DASH	D mm	L mm	
H1400200-060000	IL	DN 10	3/8"	-06	27	49	4SP/AT6K
H1400200-080000	IL	DN 12	1/2"	-08	30	52.5	4SP/R12/AT4K/AT6K
H1400200-100000	IL	DN 16	5/8"	-10	34	57.5	4SP/R12/AT4K/AT5K
H1400200-120000	IL	DN 19	3/4"	-12	38	60.1	4SP/4SH/R12/R13/AT4K/AT5K/AT6K/FXB25K
H1400200-160000	IL	DN 25	1"	-16	46	74.6	4SP/4SH/R12/R13/AT4K/AT5K/AT6K/FXB25K
H1400200-200000	IL	DN 31	1 1/4"	-20	55	88.1	4SH/R12/AT4K/AT5K
H1400200-240000	IL	DN 38	1 1/2"	-24	62	94.1	4SH/R12/AT4K/AT5K
H1400200-320000	IL	DN 51	2"	-32	78	99.1	4SH/R12/AT4K



H1400301
Interlock Ferrule

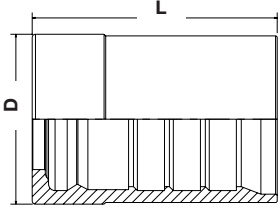

PRODUCT CODE	TYPE	HOSE BORE			DIMENSIONS		HOSE TYPE
		DN	INCH	DASH	D mm	L mm	
H1400301-100000	IL	DN 16	5/8"	-10	35.5	57.5	AT6K/AT7K
H1400301-120000	IL	DN 19	3/4"	-12	43.5	60	AT8K/FXB36K
H1400301-160000	IL	DN 25	1"	-16	52	74.8	AT8K
H1400301-200000	IL	DN 31	1 1/4"	-20	64	88.1	R13/AT5K/AT6K
H1400301-240000	IL	DN 38	1 1/2"	-24	69.5	94.1	R13/AT5K/AT6K
H1400301-320000	IL	DN 51	2"	-32	88	99.1	R13/AT5K
H1400301-400000	IL	DN 63	2 1/2"	-40	102	110	R12



H1T00600
Interlock Ferrule

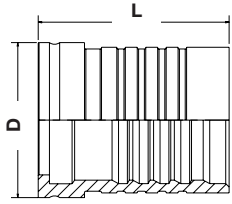

PRODUCT CODE	TYPE	HOSE BORE			DIMENSIONS		HOSE TYPE
		DN	INCH	DASH	D mm	L mm	
H1T00600-320000	IL	DN 51	2"	-32	88.1	108.2	AT6K
H1400301-400000	IL	DN 63	2 1/2"	-40	109	134.1	AT5K

INSERTS

RAPID STAPLE-LOCK INSERTS
STANDARD 78

RAPID STAPLE-LOCK INSERTS
INTERLOCK 80

SUPER RAPID STAPLE-LOCK
INSERTS - INTERLOCK 81

COMPACT INSERTS
STANDARD 82

COMPACT INSERTS
INTERLOCK 83

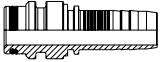
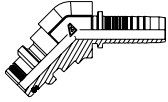
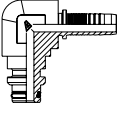
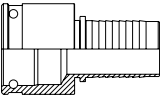

RAPID STAPLE-LOCK INSERTS - STANDARD

	H1214810 Rapid SL Male - Straight - Standard Insert SLM STD INSERT	78
	H1214840 Rapid SL Male - 45° - Standard Insert SLM STD INSERT 45	78
	H1214890 Rapid SI Male - 90° - Standard Insert SLM STD INSERT 90	78
	H1224810 Rapid SL Female - Standard Insert SLF STD INSERT	79

RAPID STAPLE-LOCK INSERTS - INTERLOCK

	H1414810 Rapid SL Male - Straight - Interlock Insert SLM IL INSERT	80
--	---	-----------

SUPER RAPID STAPLE-LOCK INSERTS - INTERLOCK

	H1414A10 Super Rapid SL Male - Straight - Interlock Insert SSLM IL INSERT	81
	H1424A10 Super Rapid SL Female - Interlock Insert SSLF IL INSERT	81
	H1424B10 Super Rapid 42 SL Female - Interlock Insert SSLF42 IL INSERT	81

COMPACT INSERTS - STANDARD

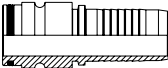
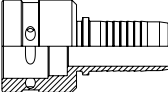
	H1213H10 Compact Male - Straight - Standard Insert CPM STD INSERT	82
	H1223H10 Compact Female - Standard Insert CPF STD INSERT	82

COMPACT INSERTS - INTERLOCK

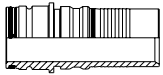

H1413H10
Compact Male - Straight - Interlock Insert
CPM IL INSERT

83

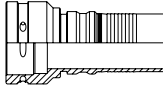

H1423H10
Compact Female - Interlock Insert
CPF IL INSERT

83



H1214810
Rapid SL Male - Straight - Standard Insert
SLM STD INSERT

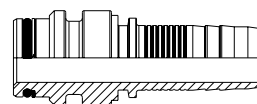

PRODUCT CODE	INSERT				T1			
	TYPE	HOSE BORE			TYPE	NOMINAL BORE		
		DN	INCH	DASH		DN	INCH	DASH
H1214810-040400	STD	DN 06	1/4"	-04	SL M	DN 06	1/4"	-04
H1214810-040600	STD	DN 06	1/4"	-04	SL M	DN 10	3/8"	-06
H1214810-060600	STD	DN 10	3/8"	-06	SL M	DN 10	3/8"	-06
H1214810-060800	STD	DN 10	3/8"	-06	SL M	DN 12	1/2"	-08
H1214810-080800	STD	DN 12	1/2"	-08	SL M	DN 12	1/2"	-08
H1214810-121200	STD	DN 19	3/4"	-12	SL M	DN 19	3/4"	-12
H1214810-161600	STD	DN 25	1"	-16	SL M	DN 25	1"	-16
H1214810-202000	STD	DN 31	1 1/4"	-20	SL M	DN 31	1 1/4"	-20
H1214810-242400	STD	DN 38	1 1/2"	-24	SL M	DN 38	1 1/2"	-24
H1214810-323200	STD	DN 51	2"	-32	SL M	DN 51	2"	-32
H1214810-484800	STD	DN 76	3"	-48	SL M	DN 76	3"	-48

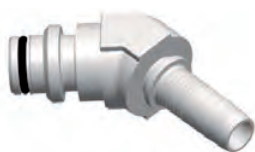

H1214840
Rapid SL Male - 45° - Standard Insert
SLM STD INSERT 45

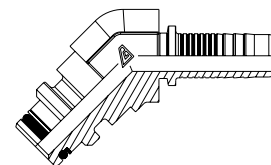

PRODUCT CODE	INSERT				T1			
	TYPE	HOSE BORE			TYPE	NOMINAL BORE		
		DN	INCH	DASH		DN	INCH	DASH
H1214840-060600	STD	DN 10	3/8"	-06	SL M	DN 10	3/8"	-06
H1214840-080800	STD	DN 12	1/2"	-08	SL M	DN 12	1/2"	-08



H1214890
Rapid SL Male - 90° - Standard Insert
SLM STD INSERT 90

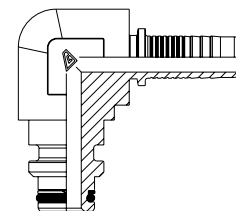

PRODUCT CODE	INSERT				T1			
	TYPE	HOSE BORE			TYPE	NOMINAL BORE		
		DN	INCH	DASH		DN	INCH	DASH
H1214890-060600	STD	DN 10	3/8"	-06	SL M	DN 10	3/8"	-06
H1214890-080800	STD	DN 12	1/2"	-08	SL M	DN 12	1/2"	-08



H1224810
Rapid SL Female - Standard Insert
SLF STD INSERT

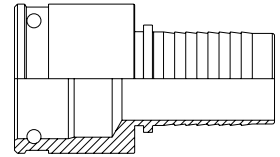

PRODUCT CODE	INSERT				T1			
	TYPE	HOSE BORE			TYPE	NOMINAL BORE		
		DN	INCH	DASH		DN	INCH	DASH
H1224810-242400	STD	DN 38	1 1/2"	-24	SL F	DN 38	1 1/2"	-24
H1224810-323200	STD	DN 51	2"	-32	SL F	DN 51	2"	-32



H1414810

Rapid SL Male - Straight - Interlock Insert
SLM IL INSERT

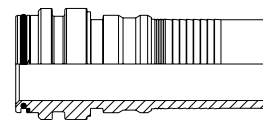

PRODUCT CODE	INSERT				T1			
	TYPE	HOSE BORE			TYPE	NOMINAL BORE		
		DN	INCH	DASH		DN	INCH	DASH
H1414810-121200	IL	DN 19	3/4"	-12	SL M	DN 19	3/4"	-12
H1414810-161600	IL	DN 25	1"	-16	SL M	DN 25	1"	-16
H1414810-202000	IL	DN 31	1 1/4"	-20	SL M	DN 31	1 1/4"	-20
H1414810-242400	IL	DN 38	1 1/2"	-24	SL M	DN 38	1 1/2"	-24
H1414810-323200	IL	DN 51	2"	-32	SL M	DN 51	2"	-32



H1414A10

Super Rapid SL Male - Straight Interlock Insert
SSLM IL INSERT

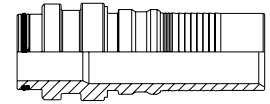

PRODUCT CODE	INSERT				T1			
	TYPE	HOSE BORE			TYPE	NOMINAL BORE		
		DN	INCH	DASH		DN	INCH	DASH
H1414A10-080800	IL	DN 12	1/2"	-08	SSL M	DN 12	1/2"	-08
H1414A10-121200	IL	DN 19	3/4"	-12	SSL M	DN 19	3/4"	-12
H1414A10-161600	IL	DN 25	1"	-16	SSL M	DN 25	1"	-16
H1414A10-202000	IL	DN 31	1 1/4"	-20	SSL M	DN 31	1 1/4"	-20
H1414A10-242400	IL	DN 38	1 1/2"	-24	SSL M	DN 38	1 1/2"	-24
H1414A10-323200	IL	DN 51	2"	-32	SSL M	DN 51	2"	-32



H1424A10

Super Rapid SL Female - Interlock Insert
SSLF IL INSERT

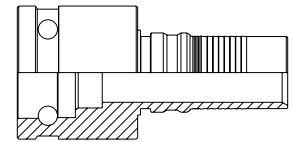

PRODUCT CODE	INSERT				T1			
	TYPE	HOSE BORE			TYPE	NOMINAL BORE		
		DN	INCH	DASH		DN	INCH	DASH
H1424A10-080800	IL	DN 12	1/2"	-08	SSL F	DN 12	1/2"	-08
H1424A10-121200	IL	DN 19	3/4"	-12	SSL F	DN 19	3/4"	-12
H1424A10-161600	IL	DN 25	1"	-16	SSL F	DN 25	1"	-16
H1424A10-202000	IL	DN 31	1 1/4"	-20	SSL F	DN 31	1 1/4"	-20
H1424A10-242400	IL	DN 38	1 1/2"	-24	SSL F	DN 38	1 1/2"	-24
H1424A10-323200	IL	DN 51	2"	-32	SSL F	DN 51	2"	-32



H1424B10

Super Rapid 42 SL Female - Interlock Insert
SSLF42 IL INSERT

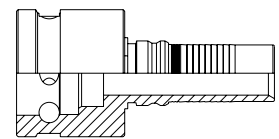

PRODUCT CODE	INSERT				T1			
	TYPE	HOSE BORE			TYPE	NOMINAL BORE		
		DN	INCH	DASH		DN	INCH	DASH
H1424B10-242442	IL	DN 38	1 1/2"	-24	SSL F	DN 38	1 1/2"	-24
H1424B10-323242	IL	DN 51	2"	-32	SSL F	DN 51	2"	-32



H1213H10
Compact Male - Straight - Standard Insert
CPM STD INSERT

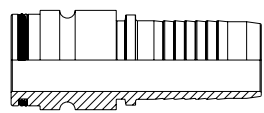

PRODUCT CODE	INSERT				T1			
	TYPE	HOSE BORE			TYPE	NOMINAL BORE		
		DN	INCH	DASH		DN	INCH	DASH
H1213H10-202000	STD	DN 31	1 1/4"	-20	CP M	DN 31	1 1/4"	-20
H1213H10-242400	STD	DN 38	1 1/2"	-24	CP M	DN 38	1 1/2"	-24
H1213H10-323200	STD	DN 51	2"	-32	CP M	DN 51	2"	-32
H1213H10-404000	STD	DN 63	2 1/2"	-40	CP M	DN 63	2 1/2"	-40



H1223H10
Compact Female - Standard Insert
CPF STD INSERT

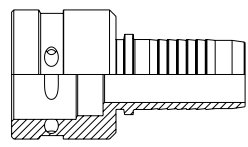

PRODUCT CODE	INSERT				T1			
	TYPE	HOSE BORE			TYPE	NOMINAL BORE		
		DN	INCH	DASH		DN	INCH	DASH
H1223H10-202000	STD	DN 31	1 1/4"	-20	CP F	DN 31	1 1/4"	-20
H1223H10-242400	STD	DN 38	1 1/2"	-24	CP F	DN 38	1 1/2"	-24
H1223H10-323200	STD	DN 51	2"	-32	CP F	DN 51	2"	-32
H1223H10-404000	STD	DN 63	2 1/2"	-40	CP F	DN 63	2 1/2"	-40



H1413H10

Compact Male - Straight - Interlock Insert
CPM IL INSERT

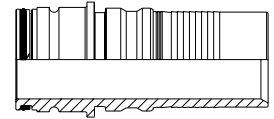

PRODUCT CODE	INSERT				T1			
	TYPE	HOSE BORE			TYPE	NOMINAL BORE		
		DN	INCH	DASH		DN	INCH	DASH
H1413H10-202000	IL	DN 31	1 1/4"	-20	CP M	DN 31	1 1/4"	-20
H1413H10-242400	IL	DN 38	1 1/2"	-24	CP M	DN 38	1 1/2"	-24
H1413H10-323200	IL	DN 51	2"	-32	CP M	DN 51	2"	-32
H1413H10-404000	IL	DN 63	2 1/2"	-40	CP M	DN 63	2 1/2"	-40



H1423H10

Compact Female - Interlock Insert
CPF IL INSERT

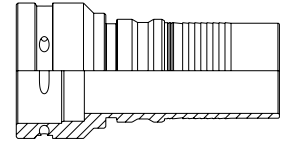

PRODUCT CODE	INSERT				T1			
	TYPE	HOSE BORE			TYPE	NOMINAL BORE		
		DN	INCH	DASH		DN	INCH	DASH
H1423H10-202000	IL	DN 31	1 1/4"	-20	CP F	DN 31	1 1/4"	-20
H1423H10-242400	IL	DN 38	1 1/2"	-24	CP F	DN 38	1 1/2"	-24
H1423H10-323200	IL	DN 51	2"	-32	CP F	DN 51	2"	-32
H1423H10-404000	IL	DN 63	2 1/2"	-40	CP F	DN 63	2 1/2"	-40



ADAPTERS

**RAPID STAPLE-LOCK
ADAPTERS86**

**SUPER RAPID STAPLE-LOCK
ADAPTERS110**

COMPACT ADAPTERS121

BULKHEAD ADAPTERS125

RAPID STAPLE-LOCK ADAPTERS

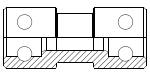

RJ-F
Rapid SL Female to Rapid SL Female - Straight
SLF-SLF

96

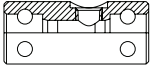

RJ-F x BT
Rapid SL Female to Rapid SL Female x BSPT Port - Straight
SLF-SLF x BT

96

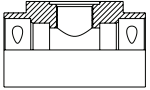

RJ-F x BP
Rapid SL Female to Rapid SL Female x BSP Port - Straight
SLF-SLF x BP

96

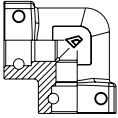

R9-F
Rapid SL Female to Rapid SL Female - 90°
SLF-SLF 90

97

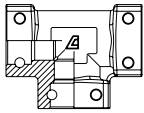

RT-F
Rapid SL Female Union Tee
SLF-SLF-SLF

97

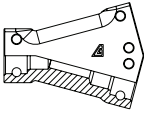

RY-F
Rapid SL Female Y
SLF-SLF-SLF Y

98

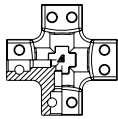

RX-F
Rapid SL Female Cross
SLF-SLF-SLF-SLF

98

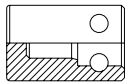

RC
Rapid SL End Cap
SLF END CAP

98

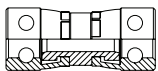

RJ-FS
Rapid SL Female Swivel to Rapid SL Female Swivel - Straight
SLFS-SLFS

99

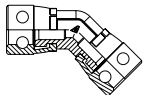

R4-FS
Rapid SL Female Swivel to Rapid SL Female Swivel - 45°
SLFS-SLFS 45

99

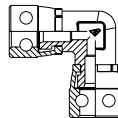

R9-FS
Rapid SL Female Swivel to Rapid SL Female Swivel - 90°
SLFS-SLFS 90

100

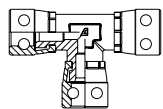

RT-FS
Rapid SL Female Swivel Union Tee
SLFS-SLFS-SLFS

100

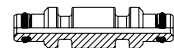

RN-M
Rapid SL Male to Rapid SL Male - Straight
SLM-SLM

101

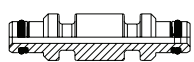
RAPID STAPLE-LOCK ADAPTERS

RN-M-L
Rapid SL Male to Rapid SL Male - Straight - Long
SLM-SLM L

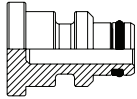
102

RP
Rapid SL Plug
SL PLUG

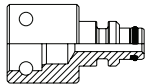
102

RR-F-M
Rapid SL Female to Rapid SL Male - Straight
SLF-SLM

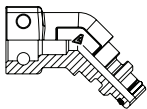
103

R4-F-M
Rapid SL Female to Rapid SL Male - 45°
SLF-SLM 45

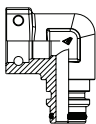
104

R9-F-M
Rapid SL Female to Rapid SL Male - 90°
SLF-SLM 90

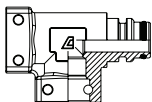
104

RT-F-M-F
Rapid SL Female to Rapid SL Male Run Tee
SLF-SLM-SLF RT

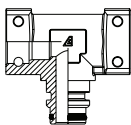
105

RT-F-F-M
Rapid SL Female to Rapid SL Male Branch Tee
SLF-SLF-SLM BT

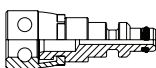
105

RR-FS-M
Rapid SL Female Swivel to Rapid SL Male - Straight
SLFS-SLM

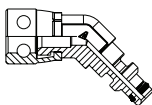
106

R4-FS-M
Rapid SL Female Swivel to Rapid SL Male - 45°
SLFS-SLM 45

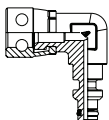
106

R9-FS-M
Rapid SL Female Swivel to Rapid SL Male - 90°
SLFS-SLM 90

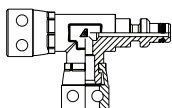
107

RT-FS-M-FS
Rapid SL Female Swivel to Rapid SL Male Run Tee
SLFS-SLM-SLFS RT

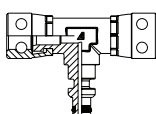
107

RT-FS-FS-M
Rapid SL Female Swivel to Rapid SL Male Branch Tee
SLFS-SLFS-SLM BT

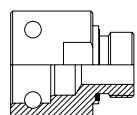
108

RTA-F-BPMCS
Rapid SL Female to BSP Male Captive Seal - Straight
SLF-BPMCS

108

RAPID STAPLE-LOCK ADAPTERS

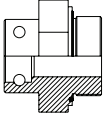
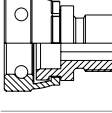
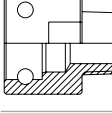
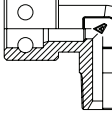
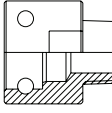
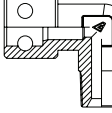
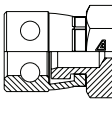
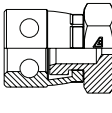
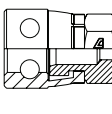
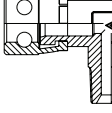
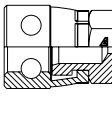
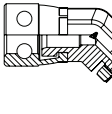
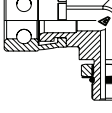
	<p>RTA-F-BPMCO Rapid SL Female to BSP Male Captive O-Ring - Straight SLF-BPMCO</p>	108
	<p>RTA-FS-BPMIH Rapid SL Female Swivel to BSP Male Internal Hex - Straight SLFS-BPMIH</p>	108
	<p>RTA-F-BTM Rapid SL Female to BSPT Male - Straight SLF-BTM</p>	109
	<p>RTA9-F-BTM Rapid SL Female to BSPT Male - 90° SLF-BTM 90</p>	109
	<p>RTA-F-NM Rapid SL Female to NPT Male - Straight SLF-NM</p>	109
	<p>RTA9-F-NM Rapid SL Female to NPT Male - 90° SLF-NM 90</p>	110
	<p>RTA-FS-BPMCS Rapid SL Female Swivel to BSP Male Captive Seal - Straight SLFS-BPMCS</p>	110
	<p>RTA-FS-BPMCO Rapid SL Female Swivel to BSP Male Captive O-Ring - Straight SLFS-BPMCO</p>	111
	<p>RTA-FS-BTM Rapid SL Female Swivel to BSPT Male - Straight SLFS-BTM</p>	111
	<p>RTA9-FS-BTM Rapid SL Female Swivel to BSPT Male - 90° SLFS-BTM 90</p>	111
	<p>RTA-FS-SORBM Rapid SL Female Swivel to SAE O-Ring Boss Male - Straight SLFS-SORBM</p>	112
	<p>RTA4-FS-SORBM Rapid SL Female Swivel to Adjustable SAE O-Ring Boss Male - 45° SLFS-SORBM 45</p>	112
	<p>RTA9-FS-SORBM Rapid SL Female Swivel to Adjustable SAE O-Ring Boss Male - 90° SLFS-SORBM 90</p>	113

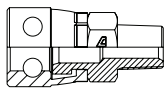
RAPID STAPLE-LOCK ADAPTERS

RTA-FS-NM
Rapid SL Female Swivel to NPT Male - Straight
SLFS-NM

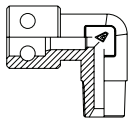
113

RTA9-FS-NM
Rapid SL Female Swivel to NPT Male - 90°
SLF-NM 90

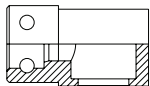
114

RB-F-BJB-BP
Rapid SL Female to Banjo Body BP
SLF-BJ BODY BP

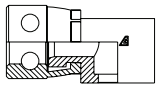
114

RB-FS-BJB-BP
Rapid SL Female Swivel to Banjo Body BP
SLFS-BJ BODY BP

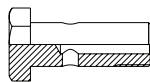
114

RB-BOLT-BPM
BSP Banjo Bolt
BJ BOLT BPM

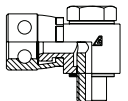
115

RB-FS-BJA-BPM
Rapid SL Female Swivel to Banjo BSP Assembly
SLFS-BJ BPM ASSY

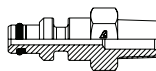
115

RTA-M-BTM
Rapid SL Male to BSPT Male - Straight
SLM-BTM

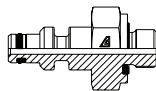
115

RTA-M-BPMCS
Rapid SL Male to BSP Male Captive Seal - Straight
SLM-BPMCS

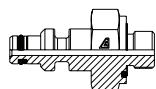
116

RTA-M-BPMCO
Rapid SL Male to BSP Male Captive O-Ring - Straight
SLM-BPMCO

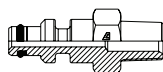
116

RTA-M-NM
Rapid SL Male to NPT Male - Straight
SLM-NM

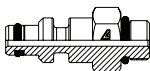
117

RTA-M-SORB
Rapid SL Male to SAE O-Ring Boss Male - Straight
SLM-SORB

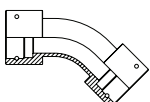
118

R4-F-SE
Rapid SL Female to Rapid SL Female - 45° Solid One Piece Swept Elbow
SLF-SLF 45 SE

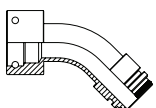
118

R4-F-M-SE
Rapid SL Female to Rapid SL Male - 45° Solid One Piece Swept Elbow
SLF-SLM 45 SE

119

RAPID STAPLE-LOCK ADAPTERS

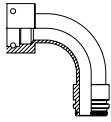

R9-F-M-SE
Rapid SL Female to Rapid SL Male - 90° Solid One Piece Swept Elbow
SLF-SLM 90 SE

119

SUPER RAPID STAPLE-LOCK ADAPTERS

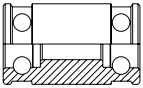

SRJ-F
Super Rapid SL Female to Super Rapid SL Female - Straight
SSLF-SSLF

120

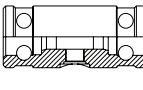

SRJ-F x BPCS
Super Rapid SL Female to Super Rapid SL Female x BSP CS Port - Straight
SSLF-SSLF x BPCS

120

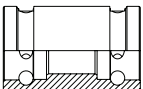

SRJ42-F
Super Rapid SL 42 MPa Female to Super Rapid SL 42 MPa Female - Straight
SSLF-SSLF 42 MPa

120

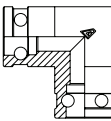

SR9-F
Super Rapid SL Female to Super Rapid SL Female - 90°
SSLF-SSLF 90

121

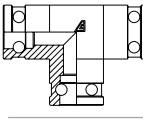

SRT-F
Super Rapid SL Female Union Tee
SSLF-SSLF-SSLF

121

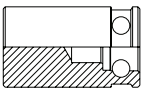

SRC-F
Super Rapid SL Female End Cap
SSLF END CAP

121

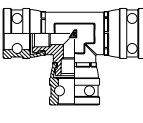

SRT-FS
Super Rapid SL Female Swivel Union Tee
SSLFS-SSLFS-SSLFS

122

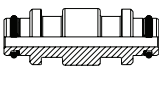

SRN-M
Super Rapid SL Male to Super Rapid SL Male - Straight
SSLM-SSLM

122

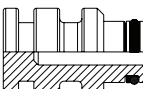

SRP-M
Super Rapid SL Male Plug
SSLM PLUG

122

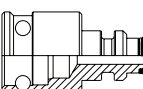

SRR-F-M
Super Rapid SL Female to Super Rapid SL Male - Straight
SSLF-SSLM

123

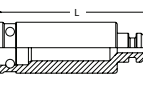

SRR-F-M-L
Super Rapid SL Female to Super Rapid SL Male - Straight - Long
SSLF-SSLM L

123

SUPER RAPID STAPLE-LOCK ADAPTERS

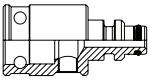
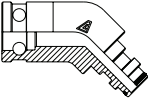
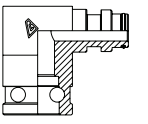
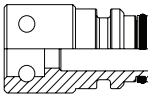
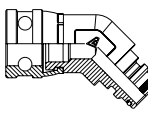
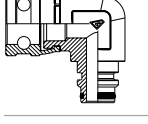
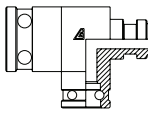
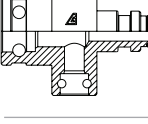
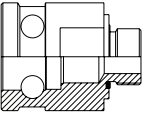
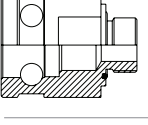
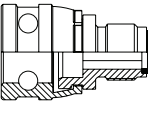
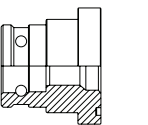
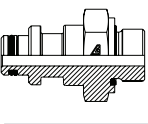
	SRR-F-M x BPCS Super Rapid SL Female to Super Rapid SL Male x BSP CS Port - Straight SSLF-SSLM x BPCS	124
	SR4-F-M Super Rapid SL Female to Super Rapid SL Male - 45° SSLF-SSLM 45	124
	SR9-F-M Super Rapid SL Female to Super Rapid SL Male - 90° SSLF-SSLM 90	124
	SRR-RF-M Rapid SL Female to Super Rapid SL Male - Straight SLF-SSLM	125
	SR4-FS-M Super Rapid SL Female Swivel to Super Rapid SL Male - 45° SSLFS-SSLM 90	125
	SR9-FS-M Super Rapid SL Female Swivel to Super Rapid SL Male - 90° SSLFS-SSLM 90	125
	SRT-F-M-F Super Rapid SL Female to Super Rapid SL Male Run Tee SSLF-SSLM-SSLF RT	126
	SRT-F-M-RF Super Rapid SL Female to Super Rapid SL Male Run Tee SSLF-SSLM-SLF - RT	126
	SRTA-F-BPMCS Super Rapid SL Female to BSP Male Captive Seal - Straight SSLF-BPMCS	127
	SRTA-F-BPMCO Super Rapid SL Female to BSP Male Captive O-Ring - Straight SSLF-BPMCO	127
	SRTA-FS-BPMIH Super Rapid SL Female Swivel to BSP Male Internal Hex - Straight SSLFS-BPMIH	127
	SRR-F-FL6K Super Rapid SL Female to SAE Flange Code 62 - Straight SSLF-FL6K	128
	SRTA-M-BPMCS Super Rapid SL Male to BSP Male Captive Seal - Straight SSLM-BPMCS	128

SUPER RAPID STAPLE-LOCK ADAPTERS

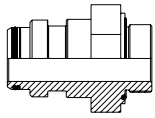

SRTA-M-BPMCO
Super Rapid SL Male to BSP Male Captive O-Ring - Straight
SSLM-BPMCO

128

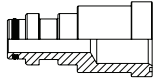

SRR-M-FL6K
Super Rapid SL Male to SAE Flange Code 62 - Straight
SSLM-FL6K

129

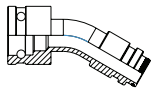

SR3-F-M-SE
Super Rapid SL Female to Super Rapid SL Male - 30° Solid One Piece Swept Elbow
SSLF-SSLM 30 SE

129

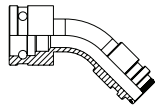

SR4-F-M-SE
Super Rapid SL Female to Super Rapid SL Male - 45° Solid One Piece Swept Elbow
SSLF-SSLM 45 SE

129

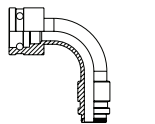

SR9-F-M-SE
Super Rapid SL Female to Super Rapid SL Male - 90° Solid One Piece Swept Elbow
SSLF-SSLM 90 SE

130

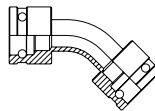

SR4-F-SE
Super Rapid SL Female to Super Rapid SL Female - 45° Solid One Piece Swept Elbow
SSLF-SSLF 45 SE

130

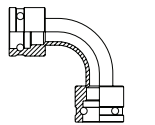

SR9-F-SE
Super Rapid SL Female to Super Rapid SL Female - 90° Solid One Piece Swept Elbow
SSLF-SSLF 90 SE

130

COMPACT ADAPTERS

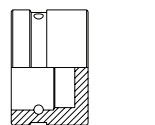

CC-F
Compact Female End Cap
CP F END CAP

131

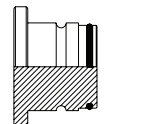

CP-M
Compact Male Plug
CP M PLUG

131

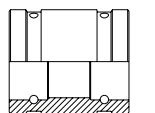

CJ-F
Compact Female to Compact Female - Straight
CPF-CPF

131

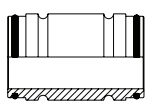

CN-M
Compact Male to Compact Male - Straight
CPM-CPM

131

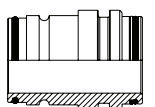

CN-M-RM
Compact Male to Rapid SL Male - Straight
CPM-SLM

132

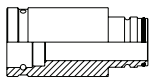
COMPACT ADAPTERS

CR-F-M
Compact Female to Compact Male - Straight
CPF-CPM

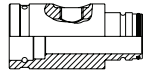
132

CR-F-M x BP
Compact Female to Compact Male x BSP Port - Straight
CPF-CPM x BP

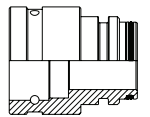
132

CR-F-RM
Compact Female to Rapid SL Male - Straight
CPF-SLM

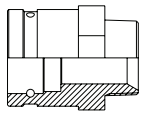
133

CTA-F-BTM
Compact Female to BSPT Male - Straight
CPF-BTM

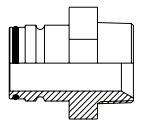
133

CTA-M-BTM
Compact Male to BSPT Male - Straight
CPM-BTM

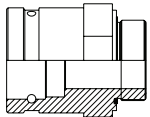
133

CTA-F-BPMCS
Compact Female to BSP Male Captive Seal - Straight
CPF-BPMCS

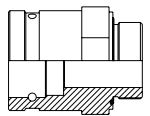
133

CTA-F-BPMCO
Compact Female to BSP Male Captive O-Ring - Straight
CPF-BPMCO

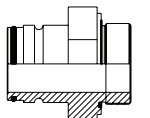
134

CTA-M-BPMCS
Compact Male to BSP Male Captive Seal - Straight
CPM-BPMCS

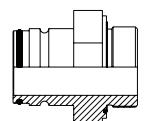
134

CTA-M-BPMCO
Compact Male to BSP Male Captive O-Ring - Straight
CPM-BPMCO

134

BULKHEAD ADAPTERS

HYDRAULIC HOSE

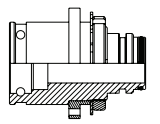

BHRR-F-M
Bulkhead Rapid SL Female to Rapid SL Male - Straight
BHSLF-SLM **135**

INDUSTRIAL HOSE

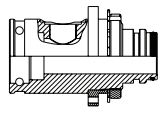

BHRR-F-M x BP
Bulkhead Rapid SL Female to Rapid SL Male x BSP Port - Straight
BHSLF-SLM x BP **135**

FERRULES

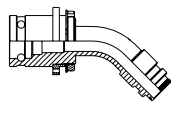

BHR4-F-M-SE
Bulkhead Rapid SL Female to Rapid SL Male - 45° Solid One Piece Swept Elbow
BHSLF-SLM 45-SE **135**

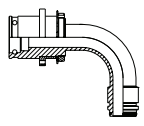

BHR9-F-M-SE
Bulkhead Rapid SL Female to Rapid SL Male - 90° Solid One Piece Swept Elbow
BHSLF-SLM 90-SE **135**

INSERTS

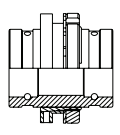

BHRJ-F-F
Bulkhead Rapid SL Female to Rapid SL Female - Straight
BHSLF-SLF **136**

ADAPTERS

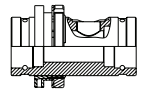

BHRJ-F-F x BP
Bulkhead Rapid SL Female to Rapid SL Female x BSP Port - Straight
BHSLF-SLF x BP **136**

ACCESSORIES

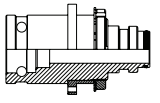

BHSRR-F-M
Bulkhead Super Rapid SL Female to Super Rapid SL Male - Straight
BHSSLF-SSLM **136**

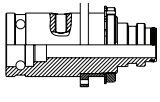

BHSRR-F-M x BPCS
Bulkhead Super Rapid SL Female to Super Rapid SL Male x BSP CS Port - Straight
BHSSLF-SSLM x BPCS **137**

BALL VALVES

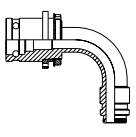

BHSR9-F-M-SE
Bulkhead Super Rapid SL Female to Super Rapid SL Male - 90° Solid One Piece Swept Elbow
BHSSLF-SSLM 90-SE **137**

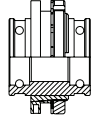

BHSRJ-F-F
Bulkhead Super Rapid SL Female to Super Rapid SL Female - Straight
BHSSLF-SSLF **137**

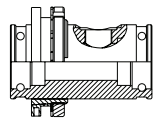

BHSRJ-F-F x BPCS
Bulkhead Super Rapid SL Female to Super Rapid SL Female x BSP CS Port - Straight
BHSSLF-SSLF x BPCS **138**

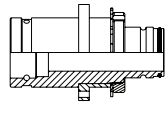

BHCR-F-M
Bulkhead Compact Female to Compact Male - Straight
BHCPF-CPM **138**

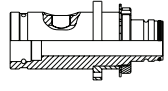

BHCR-F-M x BP
Bulkhead Compact Female to Compact Male x BSP Port - Straight
BHCPF-CPM x BP **138**

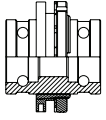
BULKHEAD ADAPTERS

BHCJ-F-F
Bulkhead Compact Female to Compact Female - Straight
BHCPF-CPF

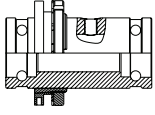
138

BHCJ-FF x BP
Bulkhead Compact Female to Compact Female x BSP Port - Straight
BHCPF-CPF x BP

139

 TECHNICAL
DATA

 HYDRAULIC
HOSE

 INDUSTRIAL
HOSE

FERRULES

INSERTS

ADAPTERS

ACCESSORIES

BALL VALVES



RJ-F
Rapid SL Female to
Rapid SL Female - Straight
SLF-SLF

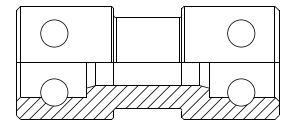

PRODUCT CODE	T1				T2			
	TYPE	NOMINAL BORE			TYPE	NOMINAL BORE		
		DN	INCH	DASH		DN	INCH	DASH
RJ-F0404	SL F	DN 06	1/4"	-04	SL F	DN 06	1/4"	-04
RJ-F0606	SL F	DN 10	3/8"	-06	SL F	DN 10	3/8"	-06
RJ-F0608	SL F	DN 10	3/8"	-06	SL F	DN 12	1/2"	-08
RJ-F0632	SL F	DN 10	3/8"	-06	SL F	DN 51	2"	-32
RJ-F0808	SL F	DN 12	1/2"	-08	SL F	DN 12	1/2"	-08
RJ-F1212	SL F	DN 19	3/4"	-12	SL F	DN 19	3/4"	-12
RJ-F1216	SL F	DN 19	3/4"	-12	SL F	DN 25	1"	-16
RJ-F1616	SL F	DN 25	1"	-16	SL F	DN 25	1"	-16
RJ-F2020	SL F	DN 31	1 1/4"	-20	SL F	DN 31	1 1/4"	-20
RJ-F2424	SL F	DN 38	1 1/2"	-24	SL F	DN 38	1 1/2"	-24
RJ-F2432	SL F	DN 38	1 1/2"	-24	SL F	DN 51	2"	-32
RJ-F3232	SL F	DN 51	2"	-32	SL F	DN 51	2"	-32
RJ-F4040	SL F	DN 63	2 1/2"	-40	SL F	DN 63	2 1/2"	-40
RJ-F4848	SL F	DN 76	3"	-48	SL F	DN 76	3"	-48



RJ-F x BT
Rapid SL Female to
Rapid SL Female x BSPT Port - Straight
SLF-SLF x BT

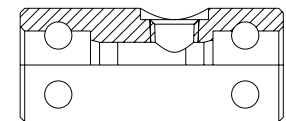

PRODUCT CODE	T1				T2				P1		
	TYPE	NOMINAL BORE			TYPE	NOMINAL BORE			TYPE	THREAD	
		DN	INCH	DASH		DN	INCH	DASH		INCH	TPI
RJ-F3232-BT16P	SL F	DN 51	2"	-32	SL F	DN 51	2"	-32	BSPT F	1"	1-11



RJ-F x BP
Rapid SL Female to
Rapid SL Female x BSP Port - Straight
SLF-SLF x BP

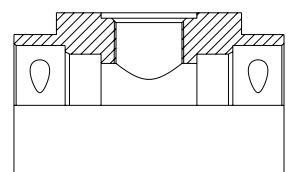

PRODUCT CODE	T1				T2				P1		
	TYPE	NOMINAL BORE			TYPE	TYPE			TYPE	THREAD	
		DN	INCH	DASH		DN	INCH	DASH		INCH	TPI
RJ-F2424-BP16P	SL F	DN 38	1 1/2"	-24	SL F	DN 38	1 1/2"	-24	BSP F	1"	1-11
RJ-F3232-BP08P	SL F	DN 51	2"	-32	SL F	DN 51	2"	-32	BSP F	1/2"	1/2-14
RJ-F3232-BP12P	SL F	DN 51	2"	-32	SL F	DN 51	2"	-32	BSP F	3/4"	3/4-14
RJ-F3232-BP16P	SL F	DN 51	2"	-32	SL F	DN 51	2"	-32	BSP F	1"	1-11



R9-F

Rapid SL Female to Rapid SL Female - 90°
SLF-SLF 90

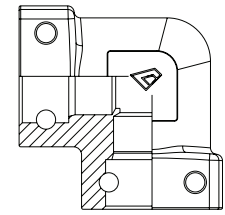

PRODUCT CODE	T1				T2			
	TYPE	NOMINAL BORE			TYPE	NOMINAL BORE		
		DN	INCH	DASH		DN	INCH	DASH
R9-F0404	SL F	DN 06	1/4"	-04	SL F	DN 06	1/4"	-04
R9-F0606	SL F	DN 10	3/8"	-06	SL F	DN 10	3/8"	-06
R9-F0808	SL F	DN 12	1/2"	-08	SL F	DN 12	1/2"	-08
R9-F1212	SL F	DN 19	3/4"	-12	SL F	DN 19	3/4"	-12
R9-F1616	SL F	DN 25	1"	-16	SL F	DN 25	1"	-16
R9-F2020	SL F	DN 31	1 1/4"	-20	SL F	DN 31	1 1/4"	-20
R9-F2424	SL F	DN 38	1 1/2"	-24	SL F	DN 38	1 1/2"	-24
R9-F3232	SL F	DN 51	2"	-32	SL F	DN 51	2"	-32
R9-F4040	SL F	DN 63	2 1/2"	-40	SL F	DN 63	2 1/2"	-40
R9-F4848	SL F	DN 76	3"	-48	SL F	DN 76	3"	-48



RT-F

Rapid SL Female Union Tee
SLF-SLF-SLF

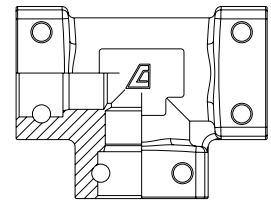

PRODUCT CODE	T1				T2				T3			
	TYPE	NOMINAL BORE			TYPE	NOMINAL BORE			TYPE	NOMINAL BORE		
		DN	INCH	DASH		DN	INCH	DASH		DN	INCH	DASH
RT-F040404	SL F	DN 06	1/4"	-04	SL F	DN 06	1/4"	-04	SL F	DN 06	1/4"	-04
RT-F040406	SL F	DN 06	1/4"	-04	SL F	DN 06	1/4"	-04	SL F	DN 10	3/8"	-06
RT-F060606	SL F	DN 10	3/8"	-06	SL F	DN 10	3/8"	-06	SL F	DN 10	3/8"	-06
RT-F060404	SL F	DN 10	3/8"	-06	SL F	DN 06	1/4"	-04	SL F	DN 06	1/4"	-04
RT-F060604	SL F	DN 10	3/8"	-06	SL F	DN 10	3/8"	-06	SL F	DN 06	1/4"	-04
RT-F080808	SL F	DN 12	1/2"	-08	SL F	DN 12	1/2"	-08	SL F	DN 12	1/2"	-08
RT-F080804	SL F	DN 12	1/2"	-08	SL F	DN 12	1/2"	-08	SL F	DN 06	1/4"	-04
RT-F080806	SL F	DN 12	1/2"	-08	SL F	DN 12	1/2"	-08	SL F	DN 10	3/8"	-06
RT-F080812	SL F	DN 12	1/2"	-08	SL F	DN 12	1/2"	-08	SL F	DN 19	3/4"	-12
RT-F121212	SL F	DN 19	3/4"	-12	SL F	DN 19	3/4"	-12	SL F	DN 19	3/4"	-12
RT-F121206	SL F	DN 19	3/4"	-12	SL F	DN 19	3/4"	-12	SL F	DN 10	3/8"	-06
RT-F121208	SL F	DN 19	3/4"	-12	SL F	DN 19	3/4"	-12	SL F	DN 12	1/2"	-08
RT-F161616	SL F	DN 25	1"	-16	SL F	DN 25	1"	-16	SL F	DN 25	1"	-16
RT-F161606	SL F	DN 25	1"	-16	SL F	DN 25	1"	-16	SL F	DN 10	3/8"	-06
RT-F161608	SL F	DN 25	1"	-16	SL F	DN 25	1"	-16	SL F	DN 12	1/2"	-08
RT-F161612	SL F	DN 25	1"	-16	SL F	DN 25	1"	-16	SL F	DN 19	3/4"	-12
RT-F202020	SL F	DN 31	1 1/4"	-20	SL F	DN 31	1 1/4"	-20	SL F	DN 31	1 1/4"	-20
RT-F202006	SL F	DN 31	1 1/4"	-20	SL F	DN 31	1 1/4"	-20	SL F	DN 10	3/8"	-06
RT-F202008	SL F	DN 31	1 1/4"	-20	SL F	DN 31	1 1/4"	-20	SL F	DN 12	1/2"	-08
RT-F202012	SL F	DN 31	1 1/4"	-20	SL F	DN 31	1 1/4"	-20	SL F	DN 19	3/4"	-12
RT-F202016	SL F	DN 31	1 1/4"	-20	SL F	DN 31	1 1/4"	-20	SL F	DN 25	1"	-16
RT-F242424	SL F	DN 38	1 1/2"	-24	SL F	DN 38	1 1/2"	-24	SL F	DN 38	1 1/2"	-24
RT-F242406	SL F	DN 38	1 1/2"	-24	SL F	DN 38	1 1/2"	-24	SL F	DN 10	3/8"	-06
RT-F242408	SL F	DN 38	1 1/2"	-24	SL F	DN 38	1 1/2"	-24	SL F	DN 12	1/2"	-08
RT-F242412	SL F	DN 38	1 1/2"	-24	SL F	DN 38	1 1/2"	-24	SL F	DN 19	3/4"	-12
RT-F242416	SL F	DN 38	1 1/2"	-24	SL F	DN 38	1 1/2"	-24	SL F	DN 25	1"	-16
RT-F242420	SL F	DN 38	1 1/2"	-24	SL F	DN 38	1 1/2"	-24	SL F	DN 31	1 1/4"	-20
RT-F323232	SL F	DN 51	2"	-32	SL F	DN 51	2"	-32	SL F	DN 51	2"	-32
RT-F323216	SL F	DN 51	2"	-32	SL F	DN 51	2"	-32	SL F	DN 25	1"	-16
RT-F323220	SL F	DN 51	2"	-32	SL F	DN 51	2"	-32	SL F	DN 31	1 1/4"	-20
RT-F323224	SL F	DN 51	2"	-32	SL F	DN 51	2"	-32	SL F	DN 38	1 1/2"	-24
RT-F404040	SL F	DN 63	2 1/2"	-40	SL F	DN 63	2 1/2"	-40	SL F	DN 63	2 1/2"	-40
RT-F404032	SL F	DN 63	2 1/2"	-40	SL F	DN 63	2 1/2"	-40	SL F	DN 51	2"	-32
RT-F484848	SL F	DN 76	3"	-48	SL F	DN 76	3"	-48	SL F	DN 76	3"	-48
RT-F484832	SL F	DN 76	3"	-48	SL F	DN 76	3"	-48	SL F	DN 51	2"	-32



RY-F
Rapid SL Female Y
SLF-SLF-SLF Y

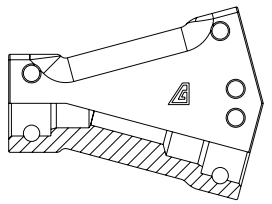

PRODUCT CODE	T1				T2				T3			
	TYPE	NOMINAL BORE			TYPE	NOMINAL BORE			TYPE	NOMINAL BORE		
		DN	INCH	DASH		DN	INCH	DASH		DN	INCH	DASH
RY-F060606	SL F	DN 10	3/8"	-06	SL F	DN 10	3/8"	-06	SL F	DN 10	3/8"	-06
RY-F080808	SL F	DN 12	1/2"	-08	SL F	DN 12	1/2"	-08	SL F	DN 12	1/2"	-08
RY-F121212	SL F	DN 19	3/4"	-12	SL F	DN 19	3/4"	-12	SL F	DN 19	3/4"	-12



RX-F
Rapid SL Female Cross
SLF-SLF-SLF-SLF

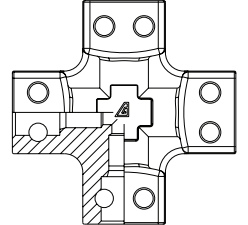

PRODUCT CODE	T1 & T2				T3 & T4			
	TYPE	NOMINAL BORE			TYPE	NOMINAL BORE		
		DN	INCH	DASH		DN	INCH	DASH
RX-F04040404	SL F	DN 06	1/4"	-04	SL F	DN 06	1/4"	-04
RX-F06060606	SL F	DN 10	3/8"	-06	SL F	DN 10	3/8"	-06
RX-F08080808	SL F	DN 12	1/2"	-08	SL F	DN 12	1/2"	-08
RX-F12121212	SL F	DN 19	3/4"	-12	SL F	DN 19	3/4"	-12
RX-F16161616	SL F	DN 25	1"	-16	SL F	DN 25	1"	-16
RX-F20202020	SL F	DN 31	1 1/4"	-20	SL F	DN 31	1 1/4"	-20



RC
Rapid SL End Cap
SLF END CAP

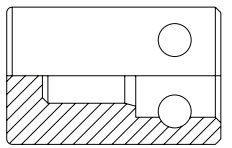

PRODUCT CODE	T1			
	TYPE	NOMINAL BORE		
		DN	INCH	DASH
RC-04	SL F	DN 06	1/4"	-04
RC-06	SL F	DN 10	3/8"	-06
RC-08	SL F	DN 12	1/2"	-08
RC-12	SL F	DN 19	3/4"	-12
RC-16	SL F	DN 25	1"	-16
RC-20	SL F	DN 31	1 1/4"	-20
RC-24	SL F	DN 38	1 1/2"	-24
RC-32	SL F	DN 51	2"	-32
RC-40	SL F	DN 63	2 1/2"	-40
RC-48	SL F	DN 76	3"	-48



RJ-FS

Rapid SL Female Swivel to
Rapid SL Female Swivel - Straight
SLFS-SLFS

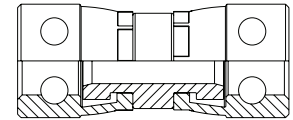

PRODUCT CODE	T1				T2			
	TYPE	NOMINAL BORE			TYPE	NOMINAL BORE		
		DN	INCH	DASH		DN	INCH	DASH
RJ-FS0404	SL FS	DN 06	1/4"	-04	SL FS	DN 06	1/4"	-04
RJ-FS0406	SL FS	DN 06	1/4"	-04	SL FS	DN 10	3/8"	-06
RJ-FS0408	SL FS	DN 06	1/4"	-04	SL FS	DN 12	1/2"	-08
RJ-FS0606	SL FS	DN 10	3/8"	-06	SL FS	DN 10	3/8"	-06
RJ-FS0608	SL FS	DN 10	3/8"	-06	SL FS	DN 12	1/2"	-08
RJ-FS0612	SL FS	DN 10	3/8"	-06	SL FS	DN 19	3/4"	-12
RJ-FS0616	SL FS	DN 10	3/8"	-06	SL FS	DN 25	1"	-16
RJ-FS0808	SL FS	DN 12	1/2"	-08	SL FS	DN 12	1/2"	-08
RJ-FS0812	SL FS	DN 12	1/2"	-08	SL FS	DN 19	3/4"	-12
RJ-FS0816	SL FS	DN 12	1/2"	-08	SL FS	DN 25	1"	-16
RJ-FS0820	SL FS	DN 12	1/2"	-08	SL FS	DN 31	1 1/4"	-20
RJ-FS1212	SL FS	DN 19	3/4"	-12	SL FS	DN 19	3/4"	-12
RJ-FS1216	SL FS	DN 19	3/4"	-12	SL FS	DN 25	1"	-16
RJ-FS1220	SL FS	DN 19	3/4"	-12	SL FS	DN 31	1 1/4"	-20
RJ-FS1616	SL FS	DN 25	1"	-16	SL FS	DN 25	1"	-16
RJ-FS1620	SL FS	DN 25	1"	-16	SL FS	DN 31	1 1/4"	-20
RJ-FS2020	SL FS	DN 31	1 1/4"	-20	SL FS	DN 31	1 1/4"	-20



R4-FS

Rapid SL Female Swivel to
Rapid SL Female Swivel - 45°
SLFS-SLFS 45

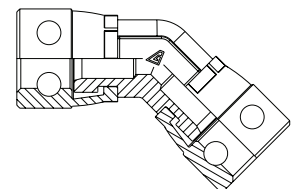

PRODUCT CODE	T1				T2			
	TYPE	NOMINAL BORE			TYPE	NOMINAL BORE		
		DN	INCH	DASH		DN	INCH	DASH
R4-FS0404	SL FS	DN 06	1/4"	-04	SL FS	DN 06	1/4"	-04
R4-FS0606	SL FS	DN 10	3/8"	-06	SL FS	DN 10	3/8"	-06
R4-FS0808	SL FS	DN 12	1/2"	-08	SL FS	DN 12	1/2"	-08
R4-FS1212	SL FS	DN 19	3/4"	-12	SL FS	DN 19	3/4"	-12
R4-FS1616	SL FS	DN 25	1"	-16	SL FS	DN 25	1"	-16
R4-FS2020	SL FS	DN 31	1 1/4"	-20	SL FS	DN 31	1 1/4"	-20



R9-FS
Rapid SL Female Swivel to
Rapid SL Female Swivel - 90°
SLFS-SLFS 90

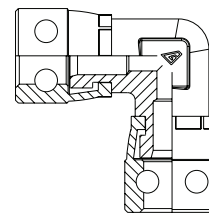

PRODUCT CODE	T1				T2			
	TYPE	NOMINAL BORE			TYPE	NOMINAL BORE		
		DN	INCH	DASH		DN	INCH	DASH
R9-FS0404	SL FS	DN 06	1/4"	-04	SL FS	DN 06	1/4"	-04
R9-FS0606	SL FS	DN 10	3/8"	-06	SL FS	DN 10	3/8"	-06
R9-FS0608	SL FS	DN 10	3/8"	-06	SL FS	DN 12	1/2"	-08
R9-FS0808	SL FS	DN 12	1/2"	-08	SL FS	DN 12	1/2"	-08
R9-FS1212	SL FS	DN 19	3/4"	-12	SL FS	DN 19	3/4"	-12
R9-FS1616	SL FS	DN 25	1"	-16	SL FS	DN 25	1"	-16
R9-FS2020	SL FS	DN 31	1 1/4"	-20	SL FS	DN 31	1 1/4"	-20



RT-FS
Rapid SL Female Swivel Union Tee
SLFS-SLFS-SLFS

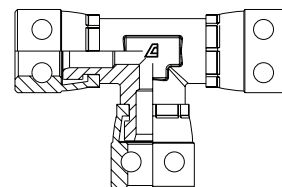

PRODUCT CODE	T1				T2				T3			
	TYPE	NOMINAL BORE			TYPE	NOMINAL BORE			TYPE	NOMINAL BORE		
		DN	INCH	DASH		DN	INCH	DASH		DN	INCH	DASH
RT-FS040404	SL FS	DN 06	1/4"	-04	SL FS	DN 06	1/4"	-04	SL FS	DN 06	1/4"	-04
RT-FS060606	SL FS	DN 10	3/8"	-06	SL FS	DN 10	3/8"	-06	SL FS	DN 10	3/8"	-06
RT-FS080808	SL FS	DN 12	1/2"	-08	SL FS	DN 12	1/2"	-08	SL FS	DN 12	1/2"	-08
RT-FS080806	SL FS	DN 12	1/2"	-08	SL FS	DN 12	1/2"	-08	SL FS	DN 10	3/8"	-06
RT-FS080812	SL FS	DN 12	1/2"	-08	SL FS	DN 12	1/2"	-08	SL FS	DN 19	3/4"	-12
RT-FS121212	SL FS	DN 19	3/4"	-12	SL FS	DN 19	3/4"	-12	SL FS	DN 19	3/4"	-12
RT-FS121206	SL FS	DN 19	3/4"	-12	SL FS	DN 19	3/4"	-12	SL FS	DN 10	3/8"	-06
RT-FS121208	SL FS	DN 19	3/4"	-12	SL FS	DN 19	3/4"	-12	SL FS	DN 12	1/2"	-08
RT-FS121216	SL FS	DN 19	3/4"	-12	SL FS	DN 19	3/4"	-12	SL FS	DN 25	1"	-16
RT-FS161616	SL FS	DN 25	1"	-16	SL FS	DN 25	1"	-16	SL FS	DN 25	1"	-16
RT-FS161606	SL FS	DN 25	1"	-16	SL FS	DN 25	1"	-16	SL FS	DN 10	3/8"	-06
RT-FS161608	SL FS	DN 25	1"	-16	SL FS	DN 25	1"	-16	SL FS	DN 12	1/2"	-08
RT-FS161612	SL FS	DN 25	1"	-16	SL FS	DN 25	1"	-16	SL FS	DN 19	3/4"	-12
RT-FS202020	SL FS	DN 31	1 1/4"	-20	SL FS	DN 31	1 1/4"	-20	SL FS	DN 31	1 1/4"	-20
RT-FS202006	SL FS	DN 31	1 1/4"	-20	SL FS	DN 31	1 1/4"	-20	SL FS	DN 10	3/8"	-06
RT-FS202008	SL FS	DN 31	1 1/4"	-20	SL FS	DN 31	1 1/4"	-20	SL FS	DN 12	1/2"	-08
RT-FS202012	SL FS	DN 31	1 1/4"	-20	SL FS	DN 31	1 1/4"	-20	SL FS	DN 19	3/4"	-12
RT-FS202016	SL FS	DN 31	1 1/4"	-20	SL FS	DN 31	1 1/4"	-20	SL FS	DN 25	1"	-16

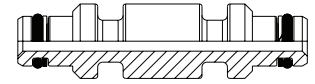

RN-M
**Rapid SL Male to Rapid SL Male - Straight
SLM-SLM**

PRODUCT CODE	T1				T2			
	TYPE	NOMINAL BORE			TYPE	NOMINAL BORE		
		DN	INCH	DASH		DN	INCH	DASH
RN-M0404	SL M	DN 06	1/4"	-04	SL M	DN 06	1/4"	-04
RN-M0406	SL M	DN 06	1/4"	-04	SL M	DN 10	3/8"	-06
RN-M0408	SL M	DN 06	1/4"	-04	SL M	DN 12	1/2"	-08
RN-M0606	SL M	DN 10	3/8"	-06	SL M	DN 10	3/8"	-06
RN-M0608	SL M	DN 10	3/8"	-06	SL M	DN 12	1/2"	-08
RN-M0612	SL M	DN 10	3/8"	-06	SL M	DN 19	3/4"	-12
RN-M0616	SL M	DN 10	3/8"	-06	SL M	DN 25	1"	-16
RN-M0620	SL M	DN 10	3/8"	-06	SL M	DN 31	1 1/4"	-20
RN-M0808	SL M	DN 12	1/2"	-08	SL M	DN 12	1/2"	-08
RN-M0812	SL M	DN 12	1/2"	-08	SL M	DN 19	3/4"	-12
RN-M0816	SL M	DN 12	1/2"	-08	SL M	DN 25	1"	-16
RN-M0820	SL M	DN 12	1/2"	-08	SL M	DN 31	1 1/4"	-20
RN-M0824	SL M	DN 12	1/2"	-08	SL M	DN 38	1 1/2"	-24
RN-M0832	SL M	DN 12	1/2"	-08	SL M	DN 51	2"	-32
RN-M1212	SL M	DN 19	3/4"	-12	SL M	DN 19	3/4"	-12
RN-M1216	SL M	DN 19	3/4"	-12	SL M	DN 25	1"	-16
RN-M1220	SL M	DN 19	3/4"	-12	SL M	DN 31	1 1/4"	-20
RN-M1224	SL M	DN 19	3/4"	-12	SL M	DN 38	1 1/2"	-24
RN-M1232	SL M	DN 19	3/4"	-12	SL M	DN 51	2"	-32
RN-M1616	SL M	DN 25	1"	-16	SL M	DN 25	1"	-16
RN-M1620	SL M	DN 25	1"	-16	SL M	DN 31	1 1/4"	-20
RN-M1624	SL M	DN 25	1"	-16	SL M	DN 38	1 1/2"	-24
RN-M1632	SL M	DN 25	1"	-16	SL M	DN 51	2"	-32
RN-M2020	SL M	DN 31	1 1/4"	-20	SL M	DN 31	1 1/4"	-20
RN-M2024	SL M	DN 31	1 1/4"	-20	SL M	DN 38	1 1/2"	-24
RN-M2032	SL M	DN 31	1 1/4"	-20	SL M	DN 51	2"	-32
RN-M2424	SL M	DN 38	1 1/2"	-24	SL M	DN 38	1 1/2"	-24
RN-M2432	SL M	DN 38	1 1/2"	-24	SL M	DN 51	2"	-32
RN-M3232	SL M	DN 51	2"	-32	SL M	DN 51	2"	-32
RN-M4040	SL M	DN 63	2 1/2"	-40	SL M	DN 63	2 1/2"	-40
RN-M4848	SL M	DN 76	3"	-48	SL M	DN 76	3"	-48

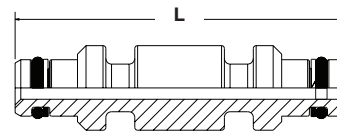

RN-M-L

Rapid SL Male to
Rapid SL Male - Straight - Long
SLM-SLM L



PRODUCT CODE	T1				T2				L MM
	TYPE	NOMINAL BORE			TYPE	NOMINAL BORE			
		DN	INCH	DASH		DN	INCH	DASH	
RN-M0606-L072	SL M	DN 10	3/8"	-06	SL M	DN 10	3/8"	-06	72
RN-M0606-L100	SL M	DN 10	3/8"	-06	SL M	DN 10	3/8"	-06	100
RN-M0606-L105	SL M	DN 10	3/8"	-06	SL M	DN 10	3/8"	-06	105
RN-M0606-L180	SL M	DN 10	3/8"	-06	SL M	DN 10	3/8"	-06	180
RN-M0808-L072	SL M	DN 12	1/2"	-08	SL M	DN 12	1/2"	-08	72
RN-M0808-L092	SL M	DN 12	1/2"	-08	SL M	DN 12	1/2"	-08	92
RN-M1212-L080	SL M	DN 19	3/4"	-12	SL M	DN 19	3/4"	-12	80
RN-M1212-L092	SL M	DN 19	3/4"	-12	SL M	DN 19	3/4"	-12	92
RN-M1212-L100	SL M	DN 19	3/4"	-12	SL M	DN 19	3/4"	-12	100
RN-M1212-L150	SL M	DN 19	3/4"	-12	SL M	DN 19	3/4"	-12	150
RN-M1616-L080	SL M	DN 25	1"	-16	SL M	DN 25	1"	-16	80
RN-M1616-L115	SL M	DN 25	1"	-16	SL M	DN 25	1"	-16	115
RN-M1616-L117	SL M	DN 25	1"	-16	SL M	DN 25	1"	-16	117
RN-M1616-L120	SL M	DN 25	1"	-16	SL M	DN 25	1"	-16	120
RN-M1616-L150	SL M	DN 25	1"	-16	SL M	DN 25	1"	-16	150
RN-M1616-L155	SL M	DN 25	1"	-16	SL M	DN 25	1"	-16	155
RN-M2020-L140	SL M	DN 31	1 1/4"	-20	SL M	DN 31	1 1/4"	-20	140



RP

Rapid SL Plug
SL PLUG

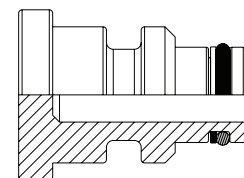

PRODUCT CODE	T1			
	TYPE	NOMINAL BORE		
		DN	INCH	DASH
RP-04	SL M	DN 06	1/4"	-04
RP-06	SL M	DN 10	3/8"	-06
RP-08	SL M	DN 12	1/2"	-08
RP-12	SL M	DN 19	3/4"	-12
RP-16	SL M	DN 25	1"	-16
RP-20	SL M	DN 31	1 1/4"	-20
RP-24	SL M	DN 38	1 1/2"	-24
RP-32	SL M	DN 51	2"	-32
RP-40	SL M	DN 63	2 1/2"	-40
RP-48	SL M	DN 76	3"	-48

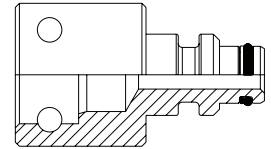

RR-F-M
**Rapid SL Female to Rapid SL Male - Straight
SLF-SLM**

PRODUCT CODE	T1				T2			
	TYPE	NOMINAL BORE			TYPE	NOMINAL BORE		
		DN	INCH	DASH		DN	INCH	DASH
RR-F04M06	SL F	DN 06	1/4"	-04	SL M	DN 10	3/8"	-06
RR-F04M12	SL F	DN 06	1/4"	-04	SL M	DN 19	3/4"	-12
RR-F06M06	SL F	DN 10	3/8"	-06	SL M	DN 10	3/8"	-06
RR-F06M08	SL F	DN 10	3/8"	-06	SL M	DN 12	1/2"	-08
RR-F06M12	SL F	DN 10	3/8"	-06	SL M	DN 19	3/4"	-12
RR-F06M16	SL F	DN 10	3/8"	-06	SL M	DN 25	1"	-16
RR-F08M06	SL F	DN 12	1/2"	-08	SL M	DN 10	3/8"	-06
RR-F08M12	SL F	DN 12	1/2"	-08	SL M	DN 19	3/4"	-12
RR-F08M16	SL F	DN 12	1/2"	-08	SL M	DN 25	1"	-16
RR-F08M20	SL F	DN 12	1/2"	-08	SL M	DN 31	1 1/4"	-20
RR-F12M08	SL F	DN 19	3/4"	-12	SL M	DN 12	1/2"	-08
RR-F12M16	SL F	DN 19	3/4"	-12	SL M	DN 25	1"	-16
RR-F12M20	SL F	DN 19	3/4"	-12	SL M	DN 31	1 1/4"	-20
RR-F12M24	SL F	DN 19	3/4"	-12	SL M	DN 38	1 1/2"	-24
RR-F16M12	SL F	DN 25	1"	-16	SL M	DN 19	3/4"	-12
RR-F16M20	SL F	DN 25	1"	-16	SL M	DN 31	1 1/4"	-20
RR-F16M24	SL F	DN 25	1"	-16	SL M	DN 38	1 1/2"	-24
RR-F16M32	SL F	DN 25	1"	-16	SL M	DN 51	2"	-32
RR-F20M12	SL F	DN 31	1 1/4"	-20	SL M	DN 19	3/4"	-12
RR-F20M24	SL F	DN 31	1 1/4"	-20	SL M	DN 38	1 1/2"	-24
RR-F20M32	SL F	DN 31	1 1/4"	-20	SL M	DN 51	2"	-32
RR-F24M06	SL F	DN 38	1 1/2"	-24	SL M	DN 10	3/8"	-06
RR-F24M12	SL F	DN 38	1 1/2"	-24	SL M	DN 19	3/4"	-12
RR-F24M24	SL F	DN 38	1 1/2"	-24	SL M	DN 38	1 1/2"	-24
RR-F32M24	SL F	DN 51	2"	-32	SL M	DN 38	1 1/2"	-24
RR-F32M32	SL F	DN 51	2"	-32	SL M	DN 51	2"	-32

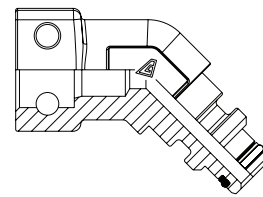

R4-F-M

Rapid SL Female to Rapid SL Male - 45°
SLF-SLM 45



PRODUCT CODE	T1				T2			
	TYPE	NOMINAL BORE			TYPE	NOMINAL BORE		
		DN	INCH	DASH		DN	INCH	DASH
R4-F06M06	SL F	DN 10	3/8"	-06	SL M	DN 10	3/8"	-06
R4-F16M16	SL F	DN 25	1"	-16	SL M	DN 25	1"	-16
R4-F24M24	SL F	DN 38	1 1/2"	-24	SL M	DN 38	1 1/2"	-24
R4-F32M32	SL F	DN 51	2"	-32	SL M	DN 51	2"	-32



R9-F-M

Rapid SL Female to Rapid SL Male - 90°
SLF-SLM 90

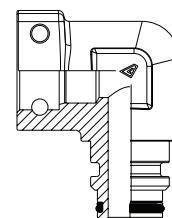

PRODUCT CODE	T1				T2			
	TYPE	NOMINAL BORE			TYPE	NOMINAL BORE		
		DN	INCH	DASH		DN	INCH	DASH
R9-F06M06	SL F	DN 10	3/8"	-06	SL M	DN 10	3/8"	-06
R9-F08M08	SL F	DN 12	1/2"	-08	SL M	DN 12	1/2"	-08
R9-F12M12	SL F	DN 19	3/4"	-12	SL M	DN 19	3/4"	-12
R9-F16M16	SL F	DN 25	1"	-16	SL M	DN 25	1"	-16
R9-F20M20	SL F	DN 31	1 1/4"	-20	SL M	DN 31	1 1/4"	-20
R9-F24M24	SL F	DN 38	1 1/2"	-24	SL M	DN 38	1 1/2"	-24
R9-F32M32	SL F	DN 51	2"	-32	SL M	DN 51	2"	-32
R9-F40M40	SL F	DN 63	2 1/2"	-40	SL M	DN 63	2 1/2"	-40



RT-F-M-F

Rapid SL Female to Rapid SL Male Run Tee
SLF-SLM-SLF RT

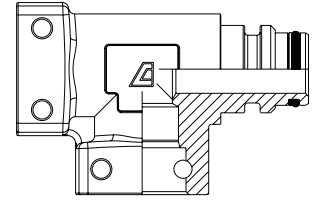

PRODUCT CODE	T1				T2				T3			
	TYPE	NOMINAL BORE			TYPE	NOMINAL BORE			TYPE	NOMINAL BORE		
		DN	INCH	DASH		DN	INCH	DASH		DN	INCH	DASH
RT-F04M04F04	SL F	DN 06	1/4"	-04	SL M	DN 06	1/4"	-04	SL F	DN 06	1/4"	-04
RT-F06M06F06	SL F	DN 10	3/8"	-06	SL M	DN 10	3/8"	-06	SL F	DN 10	3/8"	-06
RT-F08M08F06	SL F	DN 12	1/2"	-08	SL M	DN 12	1/2"	-08	SL F	DN 10	3/8"	-06
RT-F08M08F08	SL F	DN 12	1/2"	-08	SL M	DN 12	1/2"	-08	SL F	DN 12	1/2"	-08
RT-F12M12F06	SL F	DN 19	3/4"	-12	SL M	DN 19	3/4"	-12	SL F	DN 10	3/8"	-06
RT-F12M12F08	SL F	DN 19	3/4"	-12	SL M	DN 19	3/4"	-12	SL F	DN 12	1/2"	-08
RT-F12M12F12	SL F	DN 19	3/4"	-12	SL M	DN 19	3/4"	-12	SL F	DN 19	3/4"	-12
RT-F16M16F06	SL F	DN 25	1"	-16	SL M	DN 25	1"	-16	SL F	DN 10	3/8"	-06
RT-F16M16F08	SL F	DN 25	1"	-16	SL M	DN 25	1"	-16	SL F	DN 12	1/2"	-08
RT-F16M16F12	SL F	DN 25	1"	-16	SL M	DN 25	1"	-16	SL F	DN 19	3/4"	-12
RT-F16M16F16	SL F	DN 25	1"	-16	SL M	DN 25	1"	-16	SL F	DN 25	1"	-16
RT-F20M20F12	SL F	DN 31	1 1/4"	-20	SL M	DN 31	1 1/4"	-20	SL F	DN 19	3/4"	-12
RT-F20M20F20	SL F	DN 31	1 1/4"	-20	SL M	DN 31	1 1/4"	-20	SL F	DN 31	1 1/4"	-20
RT-F24M24F24	SL F	DN 38	1 1/2"	-24	SL M	DN 38	1 1/2"	-24	SL F	DN 38	1 1/2"	-24
RT-F32M32F32	SL F	DN 51	2"	-32	SL M	DN 51	2"	-32	SL F	DN 51	2"	-32
RT-F40M40F40	SL F	DN 63	2 1/2"	-40	SL M	DN 63	2 1/2"	-40	SL F	DN 63	2 1/2"	-40

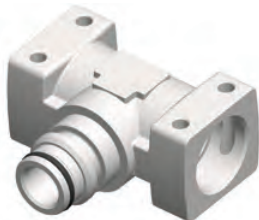

RT-F-F-M

Rapid SL Female to Rapid SL Male Branch Tee
SLF-SLF-SLM BT

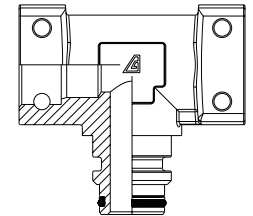

PRODUCT CODE	T1				T2				T3			
	TYPE	NOMINAL BORE			TYPE	NOMINAL BORE			TYPE	NOMINAL BORE		
		DN	INCH	DASH		DN	INCH	DASH		DN	INCH	DASH
RT-F04F04M04	SL F	DN 06	1/4"	-04	SL F	DN 06	1/4"	-04	SL M	DN 06	1/4"	-04
RT-F06F06M06	SL F	DN 10	3/8"	-06	SL F	DN 10	3/8"	-06	SL M	DN 10	3/8"	-06
RT-F08F08M08	SL F	DN 12	1/2"	-08	SL F	DN 12	1/2"	-08	SL M	DN 12	1/2"	-08
RT-F12F12M12	SL F	DN 19	3/4"	-12	SL F	DN 19	3/4"	-12	SL M	DN 19	3/4"	-12



RR-FS-M
Rapid SL Female Swivel to
Rapid SL Male - Straight
SLFS-SLM

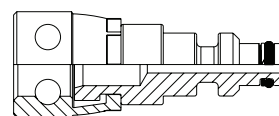

PRODUCT CODE	T1				T2			
	TYPE	NOMINAL BORE			TYPE	NOMINAL BORE		
		DN	INCH	DASH		DN	INCH	DASH
RR-FS04M04	SL FS	DN 06	1/4"	-04	SL M	DN 06	1/4"	-04
RR-FS04M06	SL FS	DN 06	1/4"	-04	SL M	DN 10	3/8"	-06
RR-FS04M08	SL FS	DN 06	1/4"	-04	SL M	DN 12	1/2"	-08
RR-FS06M04	SL FS	DN 10	3/8"	-06	SL M	DN 06	1/4"	-04
RR-FS06M06	SL FS	DN 10	3/8"	-06	SL M	DN 10	3/8"	-06
RR-FS06M08	SL FS	DN 10	3/8"	-06	SL M	DN 12	1/2"	-08
RR-FS06M12	SL FS	DN 10	3/8"	-06	SL M	DN 19	3/4"	-12
RR-FS06M16	SL FS	DN 10	3/8"	-06	SL M	DN 25	1"	-16
RR-FS06M20	SL FS	DN 10	3/8"	-06	SL M	DN 31	1 1/4"	-20
RR-FS08M04	SL FS	DN 12	1/2"	-08	SL M	DN 06	1/4"	-04
RR-FS08M06	SL FS	DN 12	1/2"	-08	SL M	DN 10	3/8"	-06
RR-FS08M08	SL FS	DN 12	1/2"	-08	SL M	DN 12	1/2"	-08
RR-FS08M12	SL FS	DN 12	1/2"	-08	SL M	DN 19	3/4"	-12
RR-FS08M16	SL FS	DN 12	1/2"	-08	SL M	DN 25	1"	-16
RR-FS08M20	SL FS	DN 12	1/2"	-08	SL M	DN 31	1 1/4"	-20
RR-FS12M06	SL FS	DN 19	3/4"	-12	SL M	DN 10	3/8"	-06
RR-FS12M08	SL FS	DN 19	3/4"	-12	SL M	DN 12	1/2"	-08
RR-FS12M12	SL FS	DN 19	3/4"	-12	SL M	DN 19	3/4"	-12
RR-FS12M16	SL FS	DN 19	3/4"	-12	SL M	DN 25	1"	-16
RR-FS12M20	SL FS	DN 19	3/4"	-12	SL M	DN 31	1 1/4"	-20
RR-FS16M06	SL FS	DN 25	1"	-16	SL M	DN 10	3/8"	-06
RR-FS16M08	SL FS	DN 25	1"	-16	SL M	DN 12	1/2"	-08
RR-FS16M12	SL FS	DN 25	1"	-16	SL M	DN 19	3/4"	-12
RR-FS16M16	SL FS	DN 25	1"	-16	SL M	DN 25	1"	-16
RR-FS16M20	SL FS	DN 25	1"	-16	SL M	DN 31	1 1/4"	-20
RR-FS16M24	SL FS	DN 25	1"	-16	SL M	DN 38	1 1/2"	-24
RR-FS16M32	SL FS	DN 25	1"	-16	SL M	DN 51	2"	-32
RR-FS20M06	SL FS	DN 31	1 1/4"	-20	SL M	DN 10	3/8"	-06
RR-FS20M08	SL FS	DN 31	1 1/4"	-20	SL M	DN 12	1/2"	-08
RR-FS20M12	SL FS	DN 31	1 1/4"	-20	SL M	DN 19	3/4"	-12
RR-FS20M16	SL FS	DN 31	1 1/4"	-20	SL M	DN 25	1"	-16
RR-FS20M20	SL FS	DN 31	1 1/4"	-20	SL M	DN 31	1 1/4"	-20
RR-FS20M24	SL FS	DN 31	1 1/4"	-20	SL M	DN 38	1 1/2"	-24
RR-FS20M32	SL FS	DN 31	1 1/4"	-20	SL M	DN 51	2"	-32



R4-FS-M
Rapid SL Female Swivel to
Rapid SL Male - 45°
SLFS-SLM 45

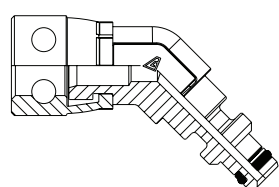

PRODUCT CODE	T1				T2			
	TYPE	NOMINAL BORE			TYPE	NOMINAL BORE		
		DN	INCH	DASH		DN	INCH	DASH
R4-FS04M04	SL FS	DN 06	1/4"	-04	SL M	DN 06	1/4"	-04
R4-FS06M06	SL FS	DN 10	3/8"	-06	SL M	DN 10	3/8"	-06
R4-FS08M08	SL FS	DN 12	1/2"	-08	SL M	DN 12	1/2"	-08
R4-FS08M06	SL FS	DN 12	1/2"	-08	SL M	DN 10	3/8"	-06
R4-FS12M12	SL FS	DN 19	3/4"	-12	SL M	DN 19	3/4"	-12
R4-FS16M16	SL FS	DN 25	1"	-16	SL M	DN 25	1"	-16
R4-FS20M20	SL FS	DN 31	1 1/4"	-20	SL M	DN 31	1 1/4"	-20



R9-FS-M

Rapid SL Female Swivel to
Rapid SL Male - 90°
SLFS-SLM 90

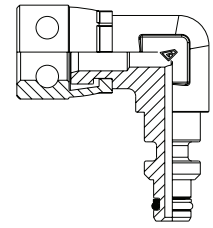

PRODUCT CODE	T1				T2			
	TYPE	NOMINAL BORE			TYPE	NOMINAL BORE		
		DN	INCH	DASH		DN	INCH	DASH
R9-FS04M04	SL FS	DN 06	1/4"	-04	SL M	DN 06	1/4"	-04
R9-FS04M06	SL FS	DN 06	1/4"	-04	SL M	DN 10	3/8"	-06
R9-FS04M08	SL FS	DN 06	1/4"	-04	SL M	DN 12	1/2"	-08
R9-FS06M06	SL FS	DN 10	3/8"	-06	SL M	DN 10	3/8"	-06
R9-FS06M04	SL FS	DN 10	3/8"	-06	SL M	DN 06	1/4"	-04
R9-FS06M08	SL FS	DN 10	3/8"	-06	SL M	DN 12	1/2"	-08
R9-FS08M08	SL FS	DN 12	1/2"	-08	SL M	DN 12	1/2"	-08
R9-FS08M04	SL FS	DN 12	1/2"	-08	SL M	DN 06	1/4"	-04
R9-FS08M06	SL FS	DN 12	1/2"	-08	SL M	DN 10	3/8"	-06
R9-FS08M12	SL FS	DN 12	1/2"	-08	SL M	DN 19	3/4"	-12
R9-FS12M12	SL FS	DN 19	3/4"	-12	SL M	DN 19	3/4"	-12
R9-FS12M08	SL FS	DN 19	3/4"	-12	SL M	DN 12	1/2"	-08
R9-FS12M16	SL FS	DN 19	3/4"	-12	SL M	DN 25	1"	-16
R9-FS12M20	SL FS	DN 19	3/4"	-12	SL M	DN 31	1 1/4"	-20
R9-FS16M16	SL FS	DN 25	1"	-16	SL M	DN 25	1"	-16
R9-FS16M12	SL FS	DN 25	1"	-16	SL M	DN 19	3/4"	-12
R9-FS16M20	SL FS	DN 25	1"	-16	SL M	DN 31	1 1/4"	-20
R9-FS20M20	SL FS	DN 31	1 1/4"	-20	SL M	DN 31	1 1/4"	-20
R9-FS20M16	SL FS	DN 31	1 1/4"	-20	SL M	DN 25	1"	-16



RT-FS-M-FS

Rapid SL Female Swivel to
Rapid SL Male Run Tee
SLFS-SLM-SLFS RT

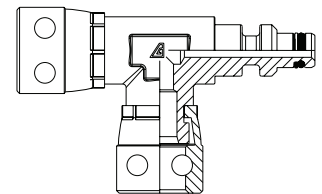

PRODUCT CODE	T1				T2				T3			
	TYPE	NOMINAL BORE			TYPE	NOMINAL BORE			TYPE	NOMINAL BORE		
		DN	INCH	DASH		DN	INCH	DASH		DN	INCH	DASH
RT-FS04M04FS04	SL FS	DN 06	1/4"	-04	SL M	DN 06	1/4"	-04	SL FS	DN 06	1/4"	-04
RT-FS04M06FS04	SL FS	DN 06	1/4"	-04	SL M	DN 10	3/8"	-06	SL FS	DN 06	1/4"	-04
RT-FS04M08FS04	SL FS	DN 06	1/4"	-04	SL M	DN 12	1/2"	-08	SL FS	DN 06	1/4"	-04
RT-FS06M06FS06	SL FS	DN 10	3/8"	-06	SL M	DN 10	3/8"	-06	SL FS	DN 10	3/8"	-06
RT-FS06M08FS06	SL FS	DN 10	3/8"	-06	SL M	DN 12	1/2"	-08	SL FS	DN 10	3/8"	-06
RT-FS08M08FS08	SL FS	DN 12	1/2"	-08	SL M	DN 12	1/2"	-08	SL FS	DN 12	1/2"	-08
RT-FS08M12FS08	SL FS	DN 12	1/2"	-08	SL M	DN 19	3/4"	-12	SL FS	DN 12	1/2"	-08
RT-FS12M12FS12	SL FS	DN 19	3/4"	-12	SL M	DN 19	3/4"	-12	SL FS	DN 19	3/4"	-12
RT-FS12M16FS12	SL FS	DN 19	3/4"	-12	SL M	DN 25	1"	-16	SL FS	DN 19	3/4"	-12
RT-FS16M16FS16	SL FS	DN 25	1"	-16	SL M	DN 25	1"	-16	SL FS	DN 25	1"	-16
RT-FS16M20FS16	SL FS	DN 25	1"	-16	SL M	DN 31	1 1/4"	-20	SL FS	DN 25	1"	-16
RT-FS20M20FS20	SL FS	DN 31	1 1/4"	-20	SL M	DN 31	1 1/4"	-20	SL FS	DN 31	1 1/4"	-20

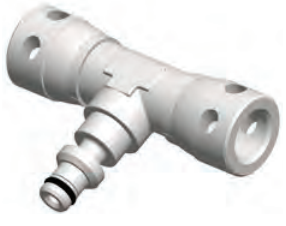

RT-FS-FS-M
 Rapid SL Female Swivel to
 Rapid SL Male Branch Tee
 SLFS-SLFS-SLM BT

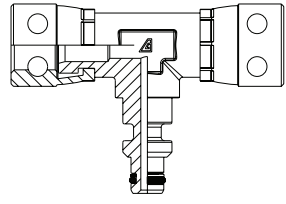

PRODUCT CODE	T1				T2				T3			
	TYPE	NOMINAL BORE			TYPE	NOMINAL BORE			TYPE	NOMINAL BORE		
		DN	INCH	DASH		DN	INCH	DASH		DN	INCH	DASH
RT-FS04FS04M04	SL FS	DN 06	1/4"	-04	SL FS	DN 06	1/4"	-04	SL M	DN 06	1/4"	-04
RT-FS04FS04M06	SL FS	DN 06	1/4"	-04	SL FS	DN 06	1/4"	-04	SL M	DN 10	3/8"	-06
RT-FS04FS04M08	SL FS	DN 06	1/4"	-04	SL FS	DN 06	1/4"	-04	SL M	DN 12	1/2"	-08
RT-FS06FS06M06	SL FS	DN 10	3/8"	-06	SL FS	DN 10	3/8"	-06	SL M	DN 10	3/8"	-06
RT-FS06FS06M08	SL FS	DN 10	3/8"	-06	SL FS	DN 10	3/8"	-06	SL M	DN 12	1/2"	-08
RT-FS08FS08M08	SL FS	DN 12	1/2"	-08	SL FS	DN 12	1/2"	-08	SL M	DN 12	1/2"	-08
RT-FS12FS12M12	SL FS	DN 19	3/4"	-12	SL FS	DN 19	3/4"	-12	SL M	DN 19	3/4"	-12
RT-FS12FS12M16	SL FS	DN 19	3/4"	-12	SL FS	DN 19	3/4"	-12	SL M	DN 19	3/4"	-12
RT-FS12FS12M20	SL FS	DN 19	3/4"	-12	SL FS	DN 19	3/4"	-12	SL M	DN 31	1 1/4"	-20
RT-FS16FS16M16	SL FS	DN 25	1"	-16	SL FS	DN 25	1"	-16	SL M	DN 25	1"	-16
RT-FS16FS16M20	SL FS	DN 25	1"	-16	SL FS	DN 25	1"	-16	SL M	DN 31	1 1/4"	-20
RT-FS20FS20M20	SL FS	DN 31	1 1/4"	-20	SL FS	DN 31	1 1/4"	-20	SL M	DN 31	1 1/4"	-20



RTA-F-BPMCS
 Rapid SL Female to
 BSP Male Captive Seal - Straight
 SLF-BPMCS

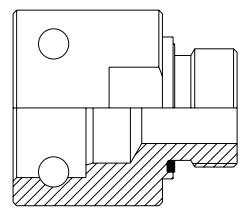

PRODUCT CODE	T1				T2		
	TYPE	NOMINAL BORE			TYPE	THREAD	
		DN	INCH	DASH		INCH	TPI
RTA-F12BPMCS12	SL F	DN 19	3/4"	-12	BSP M	3/4"	3/4-14
RTA-F16BPMCS16	SL F	DN 25	1"	-16	BSP M	1"	1-11
RTA-F16BPMCS24	SL F	DN 25	1"	-16	BSP M	1 1/2"	1 1/2-11
RTA-F20BPMCS20	SL F	DN 31	1 1/4"	-20	BSP M	1 1/4"	1 1/4-11
RTA-F24BPMCS20	SL F	DN 38	1 1/2"	-24	BSP M	1 1/4"	1 1/4-11
RTA-F24BPMCS24	SL F	DN 38	1 1/2"	-24	BSP M	1 1/2"	1 1/2-11
RTA-F32BPMCS16	SL F	DN 51	2"	-32	BSP M	1"	1-11
RTA-F32BPMCS24	SL F	DN 51	2"	-32	BSP M	1 1/2"	1 1/2-11



RTA-F-BPMCO
 Rapid SL Female to
 BSP Male Captive O-Ring - Straight
 SLF-BPMCO

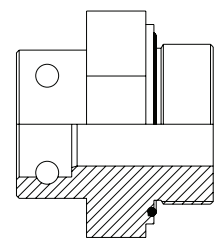

PRODUCT CODE	T1				T2		
	TYPE	NOMINAL BORE			TYPE	THREAD	
		DN	INCH	DASH		INCH	TPI
RTA-F16BPMCO32	SL F	DN 25	1"	-16	BSP M	2"	2-11
RTA-F20BPMCO32	SL F	DN 31	1 1/4"	-20	BSP M	2"	2-11
RTA-F24BPMCO32	SL F	DN 38	1 1/2"	-24	BSP M	2"	2-11
RTA-F32BPMCO32	SL F	DN 51	2"	-32	BSP M	2"	2-11
RTA-F48BPMCO40	SL F	DN 75	3"	-48	BSP M	2 1/2"	2 1/2-11
RTA-F48BPMCO48	SL F	DN 75	3"	-48	BSP M	3"	3-11



RTA-FS-BPMIH

Rapid SL Female Swivel to
BSP Male Internal Hex - Straight
SLFS-BPMIH

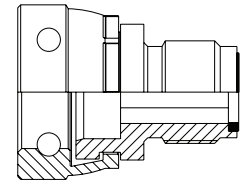

PRODUCT CODE	T1				T2		
	TYPE	NOMINAL BORE			TYPE	THREAD	
		DN	INCH	DASH		INCH	TPI
RTA-FS04BPMIH	SL FS	DN 06	1/4"	-04	BSP M	1/4"	1/4-19
RTA-FS06BPMIH	SL FS	DN 10	3/8"	-06	BSP M	3/8"	3/8-19
RTA-FS10BPMIH	SL FS	DN 12	1/2"	-08	BSP M	1/2"	1/2-14
RTA-FS12BPMIH	SL FS	DN 19	3/4"	-12	BSP M	3/4"	3/4-14



RTA-F-BTM

Rapid SL Female to BSPT Male - Straight
SLF-BTM

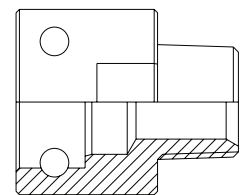

PRODUCT CODE	T1				T2		
	TYPE	NOMINAL BORE			TYPE	THREAD	
		DN	INCH	DASH		INCH	TPI
RTA-F24BTM24	SL F	DN 38	1 1/2"	-24	BSPT M	1 1/2"	1 1/2-11
RTA-F32BTM24	SL F	DN 51	2"	-32	BSPT M	1 1/2"	1 1/2-11
RTA-F32BTM32	SL F	DN 51	2"	-32	BSPT M	2"	2-11

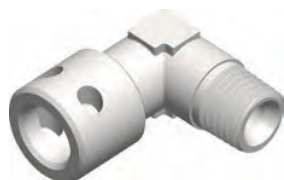

RTA9-F-BTM

Rapid SL Female to BSPT Male - 90°
SLF-BTM 90

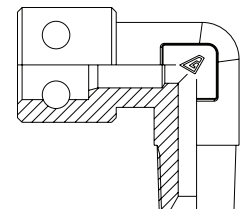

PRODUCT CODE	T1				T2		
	TYPE	NOMINAL BORE			TYPE	THREAD	
		DN	INCH	DASH		INCH	TPI
RTA9-F04BTM04	SL F	DN 06	1/4"	-04	BSPT M	1/4"	1/4-19
RTA9-F06BTM06	SL F	DN 10	3/8"	-06	BSPT M	3/8"	3/8-19
RTA9-F08BTM08	SL F	DN 12	1/2"	-08	BSPT M	1/2"	1/2-14
RTA9-F12BTM12	SL F	DN 19	3/4"	-12	BSPT M	3/4"	3/4-14



RTA-F-NM

Rapid SL Female to NPT Male - Straight
SLF-NM

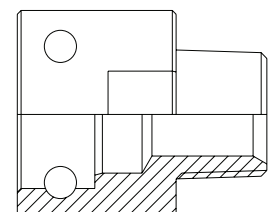

PRODUCT CODE	T1				T2		
	TYPE	NOMINAL BORE			TYPE	THREAD	
		DN	INCH	DASH		INCH	TPI
RTA-F24NM24	SL F	DN 38	1 1/2"	-24	NPT M	1 1/2"	1 1/2-11 1/2
RTA-F32NM32	SL F	DN 51	2"	-32	NPT M	2"	2-11 1/2

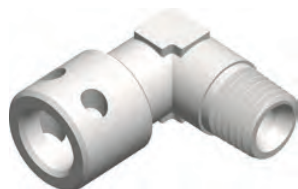

RTA9-F-NM
Rapid SL Female to NPT Male - 90°
SLF-NM 90

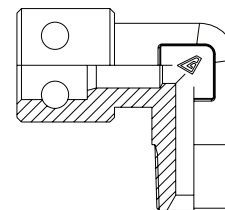

PRODUCT CODE	T1				T2		
	TYPE	NOMINAL BORE			TYPE	THREAD	
		DN	INCH	DASH		INCH	TPI
RTA9-F24NM24	SL F	DN 38	1 1/2"	-24	NPT M	1 1/2"	1 1/2-11 1/2
RTA9-F32NM32	SL F	DN 51	2"	-32	NPT M	2"	2-11 1/2



RTA-FS-BPMCS
Rapid SL Female Swivel to
BSP Male Captive Seal - Straight
SLFS-BPMCS

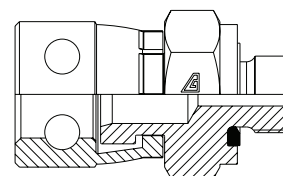

PRODUCT CODE	T1				T2		
	TYPE	NOMINAL BORE			TYPE	THREAD	
		DN	INCH	DASH		INCH	TPI
RTA-FS04BPMCS04	SL FS	DN 06	1/4"	-04	BSP M	1/4"	1/4-19
RTA-FS04BPMCS06	SL FS	DN 06	1/4"	-04	BSP M	3/8"	3/8-19
RTA-FS06BPMCS04	SL FS	DN 10	3/8"	-06	BSP M	1/4"	1/4-19
RTA-FS06BPMCS06	SL FS	DN 10	3/8"	-06	BSP M	3/8"	3/8-19
RTA-FS06BPMCS08	SL FS	DN 10	3/8"	-06	BSP M	1/2"	1/2-14
RTA-FS06BPMCS10	SL FS	DN 10	3/8"	-06	BSP M	5/8"	5/8-14
RTA-FS06BPMCS12	SL FS	DN 10	3/8"	-06	BSP M	3/4"	3/4-14
RTA-FS08BPMCS06	SL FS	DN 12	1/2"	-08	BSP M	3/8"	3/8-19
RTA-FS08BPMCS08	SL FS	DN 12	1/2"	-08	BSP M	1/2"	1/2-14
RTA-FS08BPMCS10	SL FS	DN 12	1/2"	-08	BSP M	5/8"	5/8-14
RTA-FS08BPMCS12	SL FS	DN 12	1/2"	-08	BSP M	3/4"	3/4-14
RTA-FS08BPMCS16	SL FS	DN 12	1/2"	-08	BSP M	1"	1-11
RTA-FS12BPMCS08	SL FS	DN 19	3/4"	-12	BSP M	1/2"	1/2-14
RTA-FS12BPMCS12	SL FS	DN 19	3/4"	-12	BSP M	3/4"	3/4-14
RTA-FS12BPMCS16	SL FS	DN 19	3/4"	-12	BSP M	1"	1-11
RTA-FS12BPMCS20	SL FS	DN 19	3/4"	-12	BSP M	1 1/4"	1 1/4-11
RTA-FS16BPMCS12	SL FS	DN 25	1"	-16	BSP M	3/4"	3/4-14
RTA-FS16BPMCS16	SL FS	DN 25	1"	-16	BSP M	1"	1-11
RTA-FS16BPMCS20	SL FS	DN 25	1"	-16	BSP M	1 1/4"	1 1/4-11
RTA-FS20BPMCS16	SL FS	DN 31	1 1/4"	-20	BSP M	1"	1-11
RTA-FS20BPMCS20	SL FS	DN 31	1 1/4"	-20	BSP M	1 1/4"	1 1/4-11
RTA-FS20BPMCS24	SL FS	DN 31	1 1/4"	-20	BSP M	1 1/2"	1 1/2-11
RTA-FS24BPMCS24	SL FS	DN 38	1 1/2"	-24	BSP M	1 1/2"	1 1/2-11



RTA-FS-BPMCO

Rapid SL Female Swivel to
BSP Male Captive O-Ring - Straight
SLFS-BPMCO

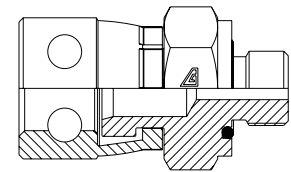

PRODUCT CODE	T1				T2		
	TYPE	NOMINAL BORE			TYPE	THREAD	
		DN	INCH	DASH		INCH	TPI
RTA-FS32BPMCO32	SL FS	DN 51	2"	-32	BSP M	2"	2-11



RTA-FS-BTM

Rapid SL Female Swivel to
BSPT Male - Straight
SLFS-BTM

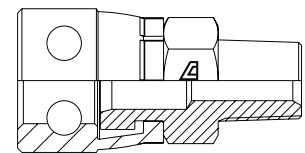

PRODUCT CODE	T1				T2		
	TYPE	NOMINAL BORE			TYPE	THREAD	
		DN	INCH	DASH		INCH	TPI
RTA-FS04BTM04	SL FS	DN 06	1/4"	-04	BSPT M	1/4"	1/4-19
RTA-FS06BTM04	SL FS	DN 10	3/8"	-06	BSPT M	1/4"	1/4-19
RTA-FS06BTM06	SL FS	DN 10	3/8"	-06	BSPT M	3/8"	3/8-19
RTA-FS06BTM08	SL FS	DN 10	3/8"	-06	BSPT M	1/2"	1/2-14
RTA-FS08BTM06	SL FS	DN 12	1/2"	-08	BSPT M	3/8"	3/8-19
RTA-FS08BTM08	SL FS	DN 12	1/2"	-08	BSPT M	1/2"	1/2-14
RTA-FS08BTM12	SL FS	DN 12	1/2"	-08	BSPT M	3/4"	3/4-14
RTA-FS12BTM08	SL FS	DN 19	3/4"	-12	BSPT M	1/2"	1/2-14
RTA-FS12BTM12	SL FS	DN 19	3/4"	-12	BSPT M	3/4"	3/4-14
RTA-FS12BTM16	SL FS	DN 19	3/4"	-12	BSPT M	1"	1-11
RTA-FS16BTM16	SL FS	DN 25	1"	-16	BSPT M	1"	1-11
RTA-FS16BTM20	SL FS	DN 25	1"	-16	BSPT M	1 1/4"	1 1/4-11
RTA-FS20BTM16	SL FS	DN 31	1 1/4"	-20	BSPT M	1"	1-11
RTA-FS20BTM20	SL FS	DN 31	1 1/4"	-20	BSPT M	1 1/4"	1 1/4-11



RTA9-FS-BTM

Rapid SL Female Swivel to BSPT Male - 90°
SLFS-BTM 90

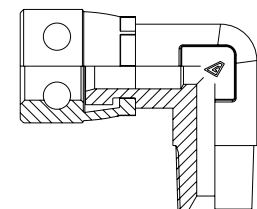

PRODUCT CODE	T1				T2		
	TYPE	NOMINAL BORE			TYPE	THREAD	
		DN	INCH	DASH		INCH	TPI
RTA9-FS04BTM04	SL FS	DN 06	1/4"	-04	BSPT M	1/4"	1/4-19
RTA9-FS06BTM06	SL FS	DN 10	3/8"	-06	BSPT M	3/8"	3/8-19
RTA9-FS08BTM08	SL FS	DN 12	1/2"	-08	BSPT M	1/2"	1/2-14



RTA-FS-SORB M

Rapid SL Female Swivel to
SAE O-Ring Boss Male - Straight
SLFS-SORB M

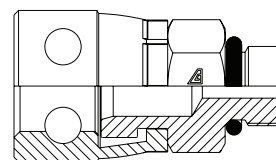

PRODUCT CODE	T1				T2		
	TYPE	NOMINAL BORE			TYPE	THREAD	
		DN	INCH	DASH		INCH	TPI
RTA-FS04SORBM04	SL FS	DN 06	1/4"	-04	SAE ORB M	1/4"	7/16-20
RTA-FS04SORBM05	SL FS	DN 06	1/4"	-04	SAE ORB M	5/16"	1/2-20
RTA-FS04SORBM06	SL FS	DN 06	1/4"	-04	SAE ORB M	3/8"	9/16-18
RTA-FS06SORBM04	SL FS	DN 10	3/8"	-06	SAE ORB M	1/4"	7/16-20
RTA-FS06SORBM06	SL FS	DN 10	3/8"	-06	SAE ORB M	3/8"	9/16-18
RTA-FS06SORBM08	SL FS	DN 10	3/8"	-06	SAE ORB M	1/2"	3/4-16
RTA-FS08SORBM06	SL FS	DN 12	1/2"	-08	SAE ORB M	3/8"	9/16-18
RTA-FS08SORBM08	SL FS	DN 12	1/2"	-08	SAE ORB M	1/2"	3/4-16
RTA-FS08SORBM10	SL FS	DN 12	1/2"	-08	SAE ORB M	5/8"	7/8-14
RTA-FS08SORBM12	SL FS	DN 12	1/2"	-08	SAE ORB M	3/4"	1 1/16-12
RTA-FS12SORBM08	SL FS	DN 19	3/4"	-12	SAE ORB M	1/2"	3/4-16
RTA-FS12SORBM10	SL FS	DN 19	3/4"	-12	SAE ORB M	5/8"	7/8-14
RTA-FS12SORBM12	SL FS	DN 19	3/4"	-12	SAE ORB M	3/4"	1 1/16-12
RTA-FS12SORBM16	SL FS	DN 19	3/4"	-12	SAE ORB M	1"	1 5/16-12
RTA-FS12SORBM20	SL FS	DN 19	3/4"	-12	SAE ORB M	1 1/4"	1 5/8-12
RTA-FS12SORBM24	SL FS	DN 19	3/4"	-12	SAE ORB M	1 1/2"	1 7/8-12
RTA-FS16SORBM12	SL FS	DN 25	1"	-16	SAE ORB M	3/4"	1 1/16-12
RTA-FS16SORBM16	SL FS	DN 25	1"	-16	SAE ORB M	1"	1 5/16-12
RTA-FS20SORBM16	SL FS	DN 31	1 1/4"	-20	SAE ORB M	1"	1 5/16-12
RTA-FS20SORBM20	SL FS	DN 31	1 1/4"	-20	SAE ORB M	1 1/4"	1 5/8-12
RTA-FS24SORBM24	SL FS	DN 38	1 1/2"	-24	SAE ORB M	1 1/2"	1 7/8-12



RTA4-FS-SORB M

Rapid SL Female Swivel to
Adjustable SAE O-Ring Boss Male - 45°
SLFS-SORB M 45

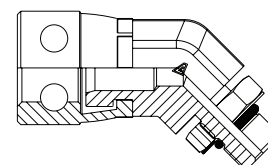

PRODUCT CODE	T1				T2		
	TYPE	NOMINAL BORE			TYPE	THREAD	
		DN	INCH	DASH		INCH	TPI
RTA4-FS06SORBM04	SL FS	DN 10	3/8"	-06	SAE ORB M	1/4"	7/16-20
RTA4-FS06SORBM06	SL FS	DN 10	3/8"	-06	SAE ORB M	3/8"	9/16-18
RTA4-FS08SORBM06	SL FS	DN 12	1/2"	-08	SAE ORB M	3/8"	9/16-18
RTA4-FS08SORBM08	SL FS	DN 12	1/2"	-08	SAE ORB M	1/2"	3/4-16
RTA4-FS08SORBM10	SL FS	DN 12	1/2"	-08	SAE ORB M	5/8"	7/8-14
RTA4-FS08SORBM12	SL FS	DN 12	1/2"	-08	SAE ORB M	3/4"	1 1/16-12
RTA4-FS12SORBM12	SL FS	DN 19	3/4"	-12	SAE ORB M	3/4"	1 1/16-12
RTA4-FS16SORBM16	SL FS	DN 25	1"	-16	SAE ORB M	1"	1 5/16-12
RTA4-FS20SORBM20	SL FS	DN 31	1 1/4"	-20	SAE ORB M	1 1/4"	1 5/8-12



RTA9-FS-SORBM

Rapid SL Female Swivel to
Adjustable SAE O-Ring Boss Male - 90°
SLFS-SORBM 90

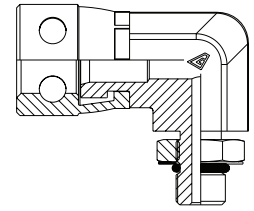

PRODUCT CODE	T1				T2		
	TYPE	NOMINAL BORE			TYPE	THREAD	
		DN	INCH	DASH		INCH	TPI
RTA9-FS06SORBM04	SL FS	DN 10	3/8"	-06	SAE ORB M	1/4"	7/16-20
RTA9-FS06SORBM06	SL FS	DN 10	3/8"	-06	SAE ORB M	3/8"	9/16-18
RTA9-FS08SORBM06	SL FS	DN 12	1/2"	-08	SAE ORB M	3/8"	9/16-18
RTA9-FS08SORBM08	SL FS	DN 12	1/2"	-08	SAE ORB M	1/2"	3/4-16
RTA9-FS08SORBM10	SL FS	DN 12	1/2"	-08	SAE ORB M	5/8"	7/8-14
RTA9-FS08SORBM12	SL FS	DN 12	1/2"	-08	SAE ORB M	3/4"	1 1/16-12
RTA9-FS12SORBM10	SL FS	DN 19	3/4"	-12	SAE ORB M	5/8"	7/8-14
RTA9-FS12SORBM12	SL FS	DN 19	3/4"	-12	SAE ORB M	3/4"	1 1/16-12
RTA9-FS16SORBM16	SL FS	DN 25	1"	-16	SAE ORB M	1"	1 5/16-12
RTA9-FS20SORBM20	SL FS	DN 31	1 1/4"	-20	SAE ORB M	1 1/4"	1 5/8-12



RTA-FS-NM

Rapid SL Female Swivel to
NPT Male - Straight
SLFS-NM

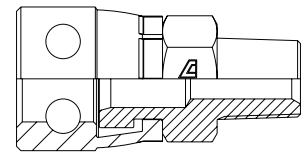

PRODUCT CODE	T1				T2		
	TYPE	NOMINAL BORE			TYPE	THREAD	
		DN	INCH	DASH		INCH	TPI
RTA-FS04NM02	SL FS	DN 06	1/4"	-04	NPT M	1/8"	1/8-27
RTA-FS04NM04	SL FS	DN 06	1/4"	-04	NPT M	1/4"	1/4-18
RTA-FS04NM06	SL FS	DN 06	1/4"	-04	NPT M	3/8"	3/8-18
RTA-FS06NM02	SL FS	DN 10	3/8"	-06	NPT M	1/8"	1/8-27
RTA-FS06NM04	SL FS	DN 10	3/8"	-06	NPT M	1/4"	1/4-18
RTA-FS06NM06	SL FS	DN 10	3/8"	-06	NPT M	3/8"	3/8-18
RTA-FS06NM08	SL FS	DN 10	3/8"	-06	NPT M	1/2"	1/2-14
RTA-FS06NM12	SL FS	DN 10	3/8"	-06	NPT M	3/4"	3/4-14
RTA-FS08NM06	SL FS	DN 12	1/2"	-08	NPT M	3/8"	3/8-18
RTA-FS08NM08	SL FS	DN 12	1/2"	-08	NPT M	1/2"	1/2-14
RTA-FS08NM12	SL FS	DN 12	1/2"	-08	NPT M	3/4"	3/4-14
RTA-FS12NM08	SL FS	DN 19	3/4"	-12	NPT M	1/2"	1/2-14
RTA-FS12NM12	SL FS	DN 19	3/4"	-12	NPT M	3/4"	3/4-14
RTA-FS12NM16	SL FS	DN 19	3/4"	-12	NPT M	1"	1-11 1/2
RTA-FS16NM12	SL FS	DN 25	1"	-16	NPT M	3/4"	3/4-14
RTA-FS16NM16	SL FS	DN 25	1"	-16	NPT M	1"	1-11 1/2
RTA-FS16NM20	SL FS	DN 25	1"	-16	NPT M	1 1/4"	1 1/4-11 1/2
RTA-FS16NM24	SL FS	DN 25	1"	-16	NPT M	1 1/2"	1 1/2-11 1/2
RTA-FS20NM16	SL FS	DN 31	1 1/4"	-20	NPT M	1"	1-11 1/2
RTA-FS20NM20	SL FS	DN 31	1 1/4"	-20	NPT M	1 1/4"	1 1/4-11 1/2
RTA-FS24NM24	SL FS	DN 38	1 1/2"	-24	NPT M	1 1/2"	1 1/2-11 1/2



RTA9-FS-NM
 Rapid SL Female Swivel to NPT Male - 90°
 SLFS-NM 90

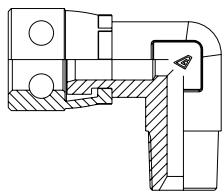

PRODUCT CODE	T1				T2		
	TYPE	NOMINAL BORE			TYPE	THREAD	
		DN	INCH	DASH		INCH	TPI
RTA9-FS04NM02	SL FS	DN 06	1/4"	-04	NPT M	1/8"	1/8-27
RTA9-FS04NM04	SL FS	DN 06	1/4"	-04	NPT M	1/4"	1/4-18
RTA9-FS04NM06	SL FS	DN 06	1/4"	-04	NPT M	3/8"	3/8-18
RTA9-FS06NM04	SL FS	DN 10	3/8"	-06	NPT M	1/4"	1/4-18
RTA9-FS06NM06	SL FS	DN 10	3/8"	-06	NPT M	3/8"	3/8-18
RTA9-FS06NM08	SL FS	DN 10	3/8"	-06	NPT M	1/2"	1/2-14
RTA9-FS08NM06	SL FS	DN 12	1/2"	-08	NPT M	3/8"	3/8-18
RTA9-FS08NM08	SL FS	DN 12	1/2"	-08	NPT M	1/2"	1/2-14
RTA9-FS08NM12	SL FS	DN 12	1/2"	-08	NPT M	3/4"	3/4-14
RTA9-FS12NM08	SL FS	DN 19	3/4"	-12	NPT M	1/2"	1/2-14
RTA9-FS12NM12	SL FS	DN 19	3/4"	-12	NPT M	3/4"	3/4-14
RTA9-FS12NM16	SL FS	DN 19	3/4"	-12	NPT M	1"	1-11 1/2
RTA9-FS16NM12	SL FS	DN 25	1"	-16	NPT M	3/4"	3/4-14
RTA9-FS16NM16	SL FS	DN 25	1"	-16	NPT M	1"	1-11 1/2
RTA9-FS20NM20	SL FS	DN 31	1 1/4"	-20	NPT M	1 1/4"	1 1/4-11 1/2

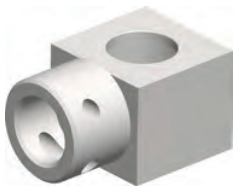

RB-F-BJB-BP
 Rapid SL Female to Banjo Body BP
 SLF-BJ BODY BP

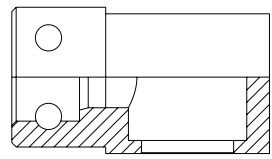

PRODUCT CODE	T1				BODY		
	TYPE	NOMINAL BORE			TYPE	NOMINAL BORE	
		DN	INCH	DASH		INCH	DASH
RB-F06BJB08	SL F	DN 10	3/8"	-06	BSP BOLT	1/2"	-08
RB-F08BJB08	SL F	DN 12	1/2"	-08	BSP BOLT	1/2"	-08

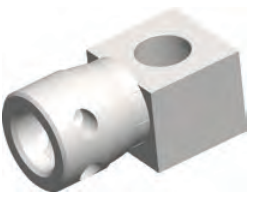

RB-FS-BJB-BP
 Rapid SL Female Swivel to Banjo Body BP
 SLFS-BJ BODY BP

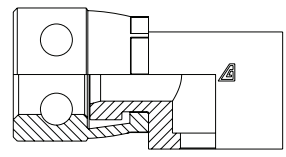

PRODUCT CODE	T1				BODY		
	TYPE	NOMINAL BORE			TYPE	NOMINAL BORE	
		DN	INCH	DASH		INCH	DASH
RB-FS04BJB04	SL FS	DN 06	1/4"	-04	BSP BOLT	1/4"	-04
RB-FS06BJB04	SL FS	DN 10	3/8"	-06	BSP BOLT	1/4"	-04
RB-FS06BJB06	SL FS	DN 10	3/8"	-06	BSP BOLT	3/8"	-06
RB-FS06BJB08	SL FS	DN 10	3/8"	-06	BSP BOLT	1/2"	-08
RB-FS08BJB06	SL FS	DN 12	1/2"	-08	BSP BOLT	3/8"	-06
RB-FS08BJB08	SL FS	DN 12	1/2"	-08	BSP BOLT	1/2"	-08
RB-FS12BJB12	SL FS	DN 19	3/4"	-12	BSP BOLT	3/4"	-12
RB-FS16BJB16	SL FS	DN 25	1"	-16	BSP BOLT	1"	-16
RB-FS20BJB20	SL FS	DN 31	1 1/4"	-20	BSP BOLT	1 1/4"	-20



RB-BOLT-BPM

BSP Banjo Bolt
BJ BOLT BPM

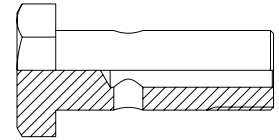

PRODUCT CODE	BOLT		
	TYPE	THREAD	
		INCH	TPI
RB-BOLTBP04	BSP M	1/4"	1/4-19
RB-BOLTBP06	BSP M	3/8"	3/8-19
RB-BOLTBP08	BSP M	1/2"	1/2-14
RB-BOLTBP12	BSP M	3/4"	3/4-14
RB-BOLTBP16	BSP M	1"	1-11
RB-BOLTBP20	BSP M	1 1/4"	1 1/4-11

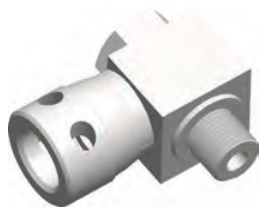

RB-FS-BJA-BPM

Rapid SL Female Swivel to Banjo BSP Assembly
SLFS-BJ BPM ASSY

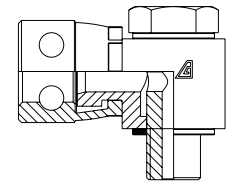

PRODUCT CODE	T1				T2		
	TYPE	NOMINAL BORE			TYPE	THREAD	
		DN	INCH	DASH		INCH	TPI
RB-FS04BJABP04	SL FS	DN 06	1/4"	-04	BSP M	1/4"	1/4-19
RB-FS06BJABP06	SL FS	DN 10	3/8"	-06	BSP M	3/8"	3/8-19
RB-FS06BJABP08	SL FS	DN 10	3/8"	-06	BSP M	1/2"	1/2-14
RB-FS08BJABP08	SL FS	DN 12	1/2"	-08	BSP M	1/2"	1/2-14
RB-FS12BJABP12	SL FS	DN 19	3/4"	-12	BSP M	3/4"	3/4-14
RB-FS16BJABP16	SL FS	DN 25	1"	-16	BSP M	1"	1-11



RTA-M-BTM

Rapid SL Male to BSPT Male - Straight
SLM-BTM

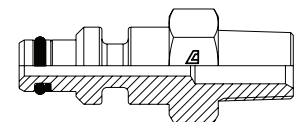

PRODUCT CODE	T1				T2		
	TYPE	NOMINAL BORE			TYPE	THREAD	
		DN	INCH	DASH		INCH	TPI
RTA-M04BTM04	SL M	DN 06	1/4"	-04	BSPT M	1/4"	1/4-19
RTA-M04BTM06	SL M	DN 06	1/4"	-04	BSPT M	3/8"	3/8-19
RTA-M06BTM04	SL M	DN 10	3/8"	-06	BSPT M	1/4"	1/4-19
RTA-M06BTM06	SL M	DN 10	3/8"	-06	BSPT M	3/8"	3/8-19
RTA-M06BTM08	SL M	DN 10	3/8"	-06	BSPT M	1/2"	1/2-14
RTA-M08BTM06	SL M	DN 12	1/2"	-08	BSPT M	3/8"	3/8-19
RTA-M08BTM08	SL M	DN 12	1/2"	-08	BSPT M	1/2"	1/2-14
RTA-M08BTM12	SL M	DN 12	1/2"	-08	BSPT M	3/4"	3/4-14
RTA-M12BTM08	SL M	DN 19	3/4"	-12	BSPT M	1/2"	1/2-14
RTA-M12BTM12	SL M	DN 19	3/4"	-12	BSPT M	3/4"	3/4-14
RTA-M12BTM16	SL M	DN 19	3/4"	-12	BSPT M	1"	1-11
RTA-M16BTM16	SL M	DN 25	1"	-16	BSPT M	1"	1-11
RTA-M16BTM20	SL M	DN 25	1"	-16	BSPT M	1 1/4"	1 1/4-11
RTA-M20BTM20	SL M	DN 31	1 1/4"	-20	BSPT M	1 1/4"	1 1/4-11
RTA-M24BTM24	SL M	DN 38	1 1/2"	-24	BSPT M	1 1/2"	1 1/2-11
RTA-M24BTM32	SL M	DN 38	1 1/2"	-24	BSPT M	2"	2-11
RTA-M32BTM32	SL M	DN 51	2"	-32	BSPT M	2"	2-11



RTA-M-BPMCS

Rapid SL Male to
BSP Male Captive Seal - Straight
SLM-BPMCS

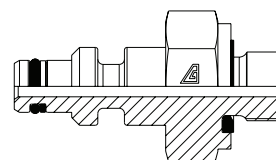

PRODUCT CODE	T1				T2		
	TYPE	NOMINAL BORE			TYPE	THREAD	
		DN	INCH	DASH		INCH	TPI
RTA-M04BPMCS04	SL M	DN 06	1/4"	-04	BSP M	1/4"	1/4-19
RTA-M04BPMCS06	SL M	DN 06	1/4"	-04	BSP M	3/8"	3/8-19
RTA-M04BPMCS08	SL M	DN 06	1/4"	-04	BSP M	1/2"	1/2-14
RTA-M06BPMCS04	SL M	DN 10	3/8"	-06	BSP M	1/4"	1/4-19
RTA-M06BPMCS06	SL M	DN 10	3/8"	-06	BSP M	3/8"	3/8-19
RTA-M06BPMCS08	SL M	DN 10	3/8"	-06	BSP M	1/2"	1/2-14
RTA-M08BPMCS06	SL M	DN 12	1/2"	-08	BSP M	3/8"	3/8-19
RTA-M08BPMCS08	SL M	DN 12	1/2"	-08	BSP M	1/2"	1/2-14
RTA-M08BPMCS12	SL M	DN 12	1/2"	-08	BSP M	3/4"	3/4-14
RTA-M08BPMCS16	SL M	DN 12	1/2"	-08	BSP M	1"	1-11
RTA-M12BPMCS08	SL M	DN 19	3/4"	-12	BSP M	1/2"	1/2-14
RTA-M12BPMCS10	SL M	DN 19	3/4"	-12	BSP M	5/8"	5/8-14
RTA-M12BPMCS12	SL M	DN 19	3/4"	-12	BSP M	3/4"	3/4-14
RTA-M12BPMCS16	SL M	DN 19	3/4"	-12	BSP M	1"	1-11
RTA-M16BPMCS12	SL M	DN 25	1"	-16	BSP M	3/4"	3/4-14
RTA-M16BPMCS16	SL M	DN 25	1"	-16	BSP M	1"	1-11
RTA-M16BPMCS20	SL M	DN 25	1"	-16	BSP M	1 1/4"	1 1/4-11
RTA-M16BPMCS24	SL M	DN 25	1"	-16	BSP M	1 1/2"	1 1/2-11
RTA-M20BPMCS16	SL M	DN 31	1 1/4"	-20	BSP M	1"	1-11
RTA-M20BPMCS20	SL M	DN 31	1 1/4"	-20	BSP M	1 1/4"	1 1/4-11
RTA-M20BPMCS24	SL M	DN 31	1 1/4"	-20	BSP M	1 1/2"	1 1/2-11
RTA-M24BPMCS20	SL M	DN 38	1 1/2"	-24	BSP M	1 1/4"	1 1/4-11
RTA-M24BPMCS24	SL M	DN 38	1 1/2"	-24	BSP M	1 1/2"	1 1/2-11
RTA-M32BPMCS16	SL M	DN 51	2"	-32	BSP M	1"	1-11
RTA-M32BPMCS24	SL M	DN 51	2"	-32	BSP M	1 1/2"	1 1/2-11



RTA-M-BPMCO

Rapid SL Male to
BSP Male Captive O-Ring - Straight
SLM-BPMCO

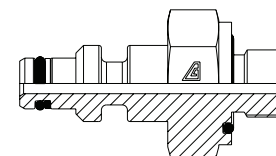

PRODUCT CODE	T1				T2		
	TYPE	NOMINAL BORE			TYPE	THREAD	
		DN	INCH	DASH		INCH	TPI
RTA-M32BPMCO32	SL M	DN 51	2"	-32	BSP M	2"	2-11



RTA-M-NM

Rapid SL Male to NPT Male - Straight SLM-NM

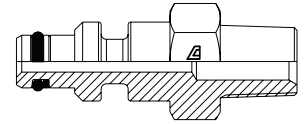

PRODUCT CODE	T1				T2		
	TYPE	NOMINAL BORE			TYPE	THREAD	
		DN	INCH	DASH		INCH	TPI
RTA-M04NM02	SL M	DN 06	1/4"	-04	NPT M	1/8"	1/8-27
RTA-M04NM04	SL M	DN 06	1/4"	-04	NPT M	1/4"	1/4-18
RTA-M04NM06	SL M	DN 06	1/4"	-04	NPT M	3/8"	3/8-18
RTA-M04NM12	SL M	DN 06	1/4"	-04	NPT M	3/4"	3/4-14
RTA-M06NM02	SL M	DN 10	3/8"	-06	NPT M	1/8"	1/8-27
RTA-M06NM04	SL M	DN 10	3/8"	-06	NPT M	1/4"	1/4-18
RTA-M06NM06	SL M	DN 10	3/8"	-06	NPT M	3/8"	3/8-18
RTA-M06NM08	SL M	DN 10	3/8"	-06	NPT M	1/2"	1/2-14
RTA-M06NM12	SL M	DN 10	3/8"	-06	NPT M	3/4"	3/4-14
RTA-M08NM04	SL M	DN 12	1/2"	-08	NPT M	1/4"	1/4-18
RTA-M08NM06	SL M	DN 12	1/2"	-08	NPT M	3/8"	3/8-18
RTA-M08NM08	SL M	DN 12	1/2"	-08	NPT M	1/2"	1/2-14
RTA-M08NM12	SL M	DN 12	1/2"	-08	NPT M	3/4"	3/4-14
RTA-M08NM16	SL M	DN 12	1/2"	-08	NPT M	1"	1-11 1/2
RTA-M12NM06	SL M	DN 19	3/4"	-12	NPT M	3/8"	3/8-18
RTA-M12NM08	SL M	DN 19	3/4"	-12	NPT M	1/2"	1/2-14
RTA-M12NM12	SL M	DN 19	3/4"	-12	NPT M	3/4"	3/4-14
RTA-M12NM16	SL M	DN 19	3/4"	-12	NPT M	1"	1-11 1/2
RTA-M16NM12	SL M	DN 25	1"	-16	NPT M	3/4"	3/4-14
RTA-M16NM16	SL M	DN 25	1"	-16	NPT M	1"	1-11 1/2
RTA-M16NM20	SL M	DN 25	1"	-16	NPT M	1 1/4"	1 1/4-11 1/2
RTA-M20NM16	SL M	DN 31	1 1/4"	-20	NPT M	1"	1-11 1/2
RTA-M20NM20	SL M	DN 31	1 1/4"	-20	NPT M	1 1/4"	1 1/4-11 1/2
RTA-M24NM20	SL M	DN 38	1 1/2"	-24	NPT M	1 1/4"	1 1/4-11 1/2
RTA-M24NM24	SL M	DN 38	1 1/2"	-24	NPT M	1 1/2"	1 1/2-11 1/2
RTA-M32NM32	SL M	DN 51	2"	-32	NPT M	2"	2-11 1/2



RTA-M-SORB
 Rapid SL Male to
 SAE O-Ring Boss Male - Straight
 SLM-SORB

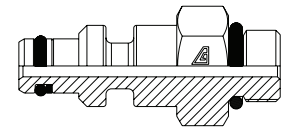

PRODUCT CODE	T1				T2		
	TYPE	NOMINAL BORE			TYPE	THREAD	
		DN	INCH	DASH		INCH	TPI
RTA-M04SORBM04	SL M	DN 06	1/4"	-04	SAE ORB M	1/4"	7/16-20
RTA-M04SORBM05	SL M	DN 06	1/4"	-04	SAE ORB M	5/16"	1/2-20
RTA-M04SORBM06	SL M	DN 06	1/4"	-04	SAE ORB M	3/8"	9/16-18
RTA-M06SORBM04	SL M	DN 10	3/8"	-06	SAE ORB M	1/4"	7/16-20
RTA-M06SORBM06	SL M	DN 10	3/8"	-06	SAE ORB M	3/8"	9/16-18
RTA-M06SORBM08	SL M	DN 10	3/8"	-06	SAE ORB M	1/2"	3/4-16
RTA-M06SORBM10	SL M	DN 10	3/8"	-06	SAE ORB M	5/8"	7/8-14
RTA-M06SORBM12	SL M	DN 10	3/8"	-06	SAE ORB M	3/4"	1 1/16-12
RTA-M08SORBM06	SL M	DN 12	1/2"	-08	SAE ORB M	3/8"	9/16-18
RTA-M08SORBM08	SL M	DN 12	1/2"	-08	SAE ORB M	1/2"	3/4-16
RTA-M08SORBM10	SL M	DN 12	1/2"	-08	SAE ORB M	5/8"	7/8-14
RTA-M08SORBM12	SL M	DN 12	1/2"	-08	SAE ORB M	3/4"	1 1/16-12
RTA-M08SORBM16	SL M	DN 12	1/2"	-08	SAE ORB M	1"	1 5/16-12
RTA-M12SORBM08	SL M	DN 19	3/4"	-12	SAE ORB M	1/2"	3/4-16
RTA-M12SORBM10	SL M	DN 19	3/4"	-12	SAE ORB M	5/8"	7/8-14
RTA-M12SORBM12	SL M	DN 19	3/4"	-12	SAE ORB M	3/4"	1 1/16-12
RTA-M12SORBM16	SL M	DN 19	3/4"	-12	SAE ORB M	1"	1 5/16-12
RTA-M16SORBM12	SL M	DN 25	1"	-16	SAE ORB M	3/4"	1 1/16-12
RTA-M16SORBM16	SL M	DN 25	1"	-16	SAE ORB M	1"	1 5/16-12
RTA-M16SORBM20	SL M	DN 25	1"	-16	SAE ORB M	1 1/4"	1 5/8-12
RTA-M20SORBM20	SL M	DN 31	1 1/4"	-20	SAE ORB M	1 1/4"	1 5/8-12



R4-F-SE
 Rapid SL Female to
 Rapid SL Female - 45°
 Solid One Piece Swept Elbow
 SLF-SLF 45 SE

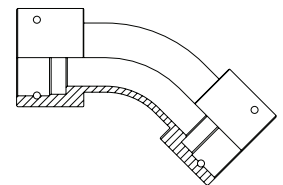

PRODUCT CODE	T1				T2			
	TYPE	NOMINAL BORE			TYPE	NOINAL BORE		
		DN	INCH	DASH		DN	INCH	DASH
R4-F40-SE	SL F	DN 63	2 1/2"	-40	SL F	DN 63	2 1/2"	-40

Staple pin holes orientation to be specified



R4-F-M-SE
 Rapid SL Female to
 Rapid SL Male - 45°
 Solid One Piece Swept Elbow
 SLF-SLM 45 SE

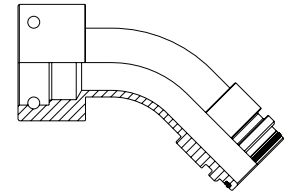

PRODUCT CODE	T1				T2			
	TYPE	NOMINAL BORE			TYPE	THREAD		
		DN	INCH	DASH		DN	INCH	DASH
R4-F24M24-SE	SL F	DN 38	1 1/2"	-24	SL M	DN 38	1 1/2"	-24
R4-F32M32-SE	SL F	DN 51	2"	-32	SL M	DN 51	2"	-32
R4-F40M40-SE	SL F	DN 63	2 1/2"	-40	SL M	DN 63	2 1/2"	-40

Staple pin holes orientation to be specified



R9-F-M-SE
 Rapid SL Female to
 Rapid SL Male - 90°
 Solid One Piece Swept Elbow
 SLF-SLM 90 SE

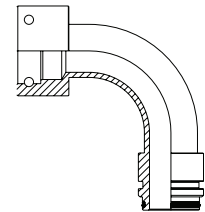

PRODUCT CODE	T1				T2			
	TYPE	NOMINAL BORE			TYPE	THREAD		
		DN	INCH	DASH		DN	INCH	DASH
R9-F24M24-SE	SL F	DN 38	1 1/2"	-24	SL M	DN 38	1 1/2"	-24
R9-F32M32-SE	SL F	DN 51	2"	-32	SL M	DN 51	2"	-32
R9-F40M40-SE	SL F	DN 63	2 1/2"	-40	SL M	DN 63	2 1/2"	-40

Staple pin holes orientation to be specified

SUPER RAPID STAPLE-LOCK ADAPTERS



SRJ-F

Super Rapid SL Female to
Super Rapid SL Female - Straight
SSLF-SSLF

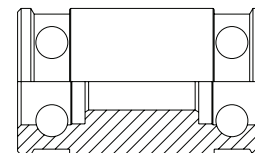

PRODUCT CODE	T1				T2			
	TYPE	NOMINAL BORE			TYPE	NOMINAL BORE		
		DN	INCH	DASH		DN	INCH	DASH
SRJ-F0612	SSL F	DN 10	3/8"	-06	SSL F	DN 19	3/4"	-12
SRJ-F0808	SSL F	DN 12	1/2"	-08	SSL F	DN 12	1/2"	-08
SRJ-F1212	SSL F	DN 19	3/4"	-12	SSL F	DN 19	3/4"	-12
SRJ-F1616	SSL F	DN 25	1"	-16	SSL F	DN 25	1"	-16
SRJ-F1624	SSL F	DN 25	1"	-16	SSL F	DN 38	1 1/2"	-24
SRJ-F2020	SSL F	DN 31	1 1/4"	-20	SSL F	DN 31	1 1/4"	-20
SRJ-F2424	SSL F	DN 38	1 1/2"	-24	SSL F	DN 38	1 1/2"	-24
SRJ-F2432	SSL F	DN 38	1 1/2"	-24	SSL F	DN 51	2"	-32
SRJ-F3232	SSL F	DN 51	2"	-32	SSL F	DN 51	2"	-32



SRJ-F x BPCS

Super Rapid SL Female to
Super Rapid SL Female x BSP CS Port - Straight
SSLF-SSLF x BPCS

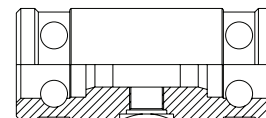

PRODUCT CODE	T1				T2				P1		
	TYPE	NOMINAL BORE			TYPE	NOMINAL BORE			TYPE	THREAD	
		DN	INCH	DASH		DN	INCH	DASH		INCH	TPI
SRJ-F2020-BP06P	SSL F	DN 31	1 1/4"	-20	SSL F	DN 31	1 1/4"	-20	BSP CS	3/8"	3/8-19
SRJ-F2020-BP08P	SSL F	DN 31	1 1/4"	-20	SSL F	DN 31	1 1/4"	-20	BSP CS	1/2"	1/2-14
SRJ-F2020-BP12P	SSL F	DN 31	1 1/4"	-20	SSL F	DN 31	1 1/4"	-20	BSP CS	3/4"	3/4-14
SRJ-F2424-BP06P	SSL F	DN 38	1 1/2"	-24	SSL F	DN 38	1 1/2"	-24	BSP CS	3/8"	3/8-19
SRJ-F2424-BPP8P	SSL F	DN 38	1 1/2"	-24	SSL F	DN 38	1 1/2"	-24	BSP CS	1/2"	1/2-14
SRJ-F2424-BP12P	SSL F	DN 38	1 1/2"	-24	SSL F	DN 38	1 1/2"	-24	BSP CS	3/4"	3/4-14
SRJ-F2424-BP16P	SSL F	DN 38	1 1/2"	-24	SSL F	DN 38	1 1/2"	-24	BSP CS	1"	1-11
SRJ-F3232-BP12P	SSL F	DN 51	2"	-32	SSL F	DN 51	2"	-32	BSP CS	3/4"	3/4-14



SRJ42-F

Super Rapid SL 42 MPa Female to
Super Rapid SL 42 MPa Female - Straight
SSLF-SSLF 42 MPa

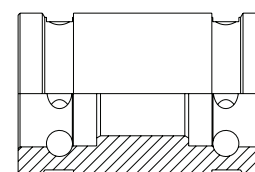

PRODUCT CODE	T1				T2			
	TYPE	NOMINAL BORE			TYPE	NOMINAL BORE		
		DN	INCH	DASH		DN	INCH	DASH
SRJ42-F2424	SSL F	DN 38	1 1/2"	-24	SSL F	DN 38	1 1/2"	-24
SRJ42-F3232	SSL F	DN 51	2"	-32	SSL F	DN 51	2"	-32

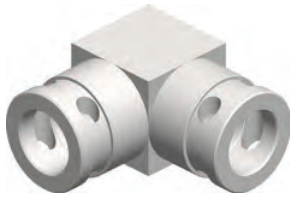

SR9-F
 Super Rapid SL Female to
 Super Rapid SL Female - 90°
 SSLF-SSLF 90

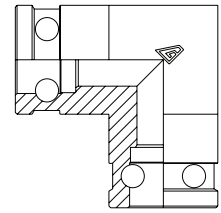

PRODUCT CODE	T1				T2			
	TYPE	NOMINAL BORE			TYPE	NOMINAL BORE		
		DN	INCH	DASH		DN	INCH	DASH
SR9-F1212	SSL F	DN 19	3/4"	-12	SSL F	DN 19	3/4"	-12
SR9-F1616	SSL F	DN 25	1"	-16	SSL F	DN 25	1"	-16
SR9-F2020	SSL F	DN 31	1 1/4"	-20	SSL F	DN 31	1 1/4"	-20
SR9-F2424	SSL F	DN 38	1 1/2"	-24	SSL F	DN 38	1 1/2"	-24
SR9-F3232	SSL F	DN 51	2"	-32	SSL F	DN 51	2"	-32

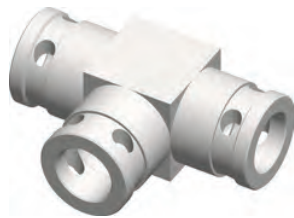

SRT-F
 Super Rapid SL Female Union Tee
 SSLF-SSLF-SSLF

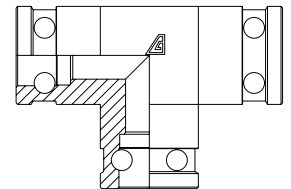

PRODUCT CODE	T1				T2				T3			
	TYPE	NOMINAL BORE			TYPE	NOMINAL BORE			TYPE	NOMINAL BORE		
		DN	INCH	DASH		DN	INCH	DASH		DN	INCH	DASH
SRT-F121208	SSL F	DN 19	3/4"	-12	SSL F	DN 19	3/4"	-12	SSL F	DN 12	1/2"	-08
SRT-F121212	SSL F	DN 19	3/4"	-12	SSL F	DN 19	3/4"	-12	SSL F	DN 19	3/4"	-12
SRT-F161616	SSL F	DN 25	1"	-16	SSL F	DN 25	1"	-16	SSL F	DN 25	1"	-16
SRT-F202020	SSL F	DN 31	1 1/4"	-20	SSL F	DN 31	1 1/4"	-20	SSL F	DN 31	1 1/4"	-20
SRT-F242420	SSL F	DN 38	1 1/2"	-24	SSL F	DN 38	1 1/2"	-24	SSL F	DN 31	1 1/4"	-20
SRT-F242424	SSL F	DN 38	1 1/2"	-24	SSL F	DN 38	1 1/2"	-24	SSL F	DN 38	1 1/2"	-24
SRT-F323220	SSL F	DN 51	2"	-32	SSL F	DN 51	2"	-32	SSL F	DN 31	1 1/4"	-20
SRT-F323232	SSL F	DN 51	2"	-32	SSL F	DN 51	2"	-32	SSL F	DN 51	2"	-32



SRC-F
 Super Rapid SL Female End Cap
 SSLF END CAP

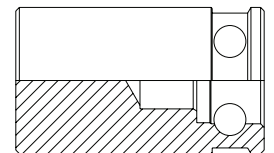

PRODUCT CODE	T1			
	TYPE	NOMINAL BORE		
		DN	INCH	DASH
SRC-08	SSL F	DN 12	1/2"	-08
SRC-12	SSL F	DN 19	3/4"	-12
SRC-16	SSL F	DN 25	1"	-16
SRC-20	SSL F	DN 31	1 1/4"	-20
SRC-24	SSL F	DN 38	1 1/2"	-24
SRC-32	SSL F	DN 51	2"	-32

SUPER RAPID STAPLE-LOCK ADAPTERS



SRT-FS
Super Rapid SL Female Swivel Union Tee
SSLFS-SSLFS-SSLFS

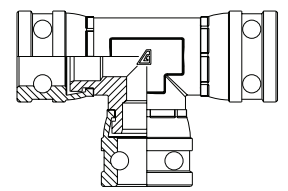

PRODUCT CODE	T1				T2				T3			
	TYPE	NOMINAL BORE			TYPE	NOMINAL BORE			TYPE	NOMINAL BORE		
		DN	INCH	DASH		DN	INCH	DASH		DN	INCH	DASH
SRT-FS080808	SSL FS	DN 12	1/2"	-08	SSL FS	DN 12	1/2"	-08	SSL FS	DN 12	1/2"	-08
SRT-FS080812	SSL FS	DN 12	1/2"	-08	SSL FS	DN 12	1/2"	-08	SSL FS	DN 19	3/4"	-12
SRT-FS121208	SSL FS	DN 19	3/4"	-12	SSL FS	DN 19	3/4"	-12	SSL FS	DN 12	1/2"	-08
SRT-FS121212	SSL FS	DN 19	3/4"	-12	SSL FS	DN 19	3/4"	-12	SSL FS	DN 19	3/4"	-12
SRT-FS161608	SSL FS	DN 25	1"	-16	SSL FS	DN 25	1"	-16	SSL FS	DN 12	1/2"	-08
SRT-FS161612	SSL FS	DN 25	1"	-16	SSL FS	DN 25	1"	-16	SSL FS	DN 19	3/4"	-12
SRT-FS161616	SSL FS	DN 25	1"	-16	SSL FS	DN 25	1"	-16	SSL FS	DN 25	1"	-16



SRN-M
Super Rapid SL Male to Super Rapid SL Male - Straight
SSLM-SSLM

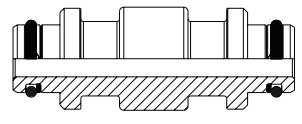

PRODUCT CODE	T1				T2			
	TYPE	NOMINAL BORE			TYPE	NOMINAL BORE		
		DN	INCH	DASH		DN	INCH	DASH
SRN-M0808	SSL M	DN 12	1/2"	-08	SSL M	DN 12	1/2"	-08
SRN-M0812	SSL M	DN 12	1/2"	-08	SSL M	DN 19	3/4"	-12
SRN-M1212	SSL M	DN 19	3/4"	-12	SSL M	DN 19	3/4"	-12
SRN-M1616	SSL M	DN 25	1"	-16	SSL M	DN 25	1"	-16
SRN-M1216	SSL M	DN 19	3/4"	-12	SSL M	DN 25	1"	-16
SRN-M2020	SSL M	DN 31	1 1/4"	-20	SSL M	DN 31	1 1/4"	-20
SRN-M1620	SSL M	DN 25	1"	-16	SSL M	DN 31	1 1/4"	-20
SRN-M2024	SSL M	DN 31	1 1/4"	-20	SSL M	DN 38	1 1/2"	-24
SRN-M2032	SSL M	DN 31	1 1/4"	-20	SSL M	DN 51	2"	-32
SRN-M2424	SSL M	DN 38	1 1/2"	-24	SSL M	DN 38	1 1/2"	-24
SRN-M2432	SSL M	DN 38	1 1/2"	-24	SSL M	DN 51	2"	-32
SRN-M3232	SSL M	DN 51	2"	-32	SSL M	DN 51	2"	-32



SRP-M
Super Rapid SL Male Plug
SSLM PLUG

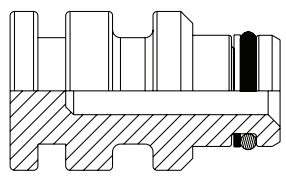

PRODUCT CODE	T1			
	TYPE	NOMINAL BORE		
		DN	INCH	DASH
SRP-08	SSL M	DN 12	1/2"	-08
SRP-12	SSL M	DN 19	3/4"	-12
SRP-16	SSL M	DN 25	1"	-16
SRP-20	SSL M	DN 31	1 1/4"	-20
SRP-24	SSL M	DN 38	1 1/2"	-24
SRP-32	SSL M	DN 51	2"	-32

SRR-F-M

Super Rapid SL Female to
Super Rapid SL Male - Straight
SSLF-SSLM

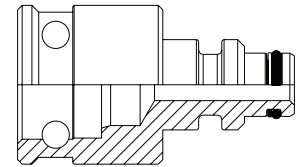

PRODUCT CODE	T1				T2			
	TYPE	NOMINAL BORE			TYPE	NOMINAL BORE		
		DN	INCH	DASH		DN	INCH	DASH
SRR-F08M12	SSL F	DN 12	1/2"	-08	SSL M	DN 19	3/4"	-12
SRR-F08M24	SSL F	DN 12	1/2"	-08	SSL M	DN 38	1 1/2"	-24
SRR-F12M12	SSL F	DN 19	3/4"	-12	SSL M	DN 19	3/4"	-12
SRR-F12M16	SSL F	DN 19	3/4"	-12	SSL M	DN 25	1"	-16
SRR-F16M12	SSL F	DN 25	1"	-16	SSL M	DN 19	3/4"	-12
SRR-F16M16	SSL F	DN 25	1"	-16	SSL M	DN 25	1"	-16
SRR-F20M20	SSL F	DN 31	1 1/4"	-20	SSL M	DN 31	1 1/4"	-20
SRR-F20M24	SSL F	DN 31	1 1/4"	-20	SSL M	DN 38	1 1/2"	-24
SRR-F20M32	SSL F	DN 31	1 1/4"	-20	SSL M	DN 51	2"	-32
SRR-F24M12	SSL F	DN 38	1 1/2"	-24	SSL M	DN 19	3/4"	-12
SRR-F24M20	SSL F	DN 38	1 1/2"	-24	SSL M	DN 31	1 1/4"	-20
SRR-F24M32	SSL F	DN 38	1 1/2"	-24	SSL M	DN 51	2"	-32
SRR-F24M24	SSL F	DN 38	1 1/2"	-24	SSL M	DN 38	1 1/2"	-24
SRR-F32M32	SSL F	DN 51	2"	-32	SSL M	DN 51	2"	-32
SRR-F32M20	SSL F	DN 51	2"	-32	SSL M	DN 31	1 1/4"	-20
SRR-F32M24	SSL F	DN 51	2"	-32	SSL M	DN 38	1 1/2"	-24
SRR-F32M32	SSL F	DN 51	2"	-32	SSL M	DN 51	2"	-32

SRR-F-M-L

Super Rapid SL Female to
Super Rapid SL Male - Straight - Long
SSLF-SSLM L

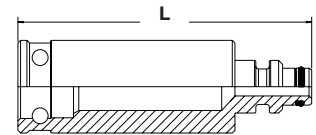

PRODUCT CODE	T1				T2				L
	TYPE	NOMINAL BORE			TYPE	NOMINAL BORE			
		DN	INCH	DASH		DN	INCH	DASH	MM
SRR-F32M32-L114	SSL F	DN 51	2"	-32	SSL M	DN 51	2"	-32	114
SRR-F32M32-L190	SSL F	DN 51	2"	-32	SSL M	DN 51	2"	-32	190
SRR-F32M32-L357	SSL F	DN 51	2"	-32	SSL M	DN 51	2"	-32	357

SUPER RAPID STAPLE-LOCK ADAPTERS



SRR-F-M x BPCS

Super Rapid SL Female to
Super Rapid SL Male x BSP CS Port - Straight
SSLF-SSLM x BPCS

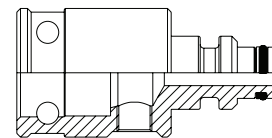

PRODUCT CODE	T1				T2				P1		
	TYPE	NOMINAL BORE			TYPE	NOMINAL BORE			TYPE	THREAD	
		DN	INCH	DASH		DN	INCH	DASH		INCH	TPI
SRR-F12M12-BP08P	SSL F	DN 19	3/4"	-12	SSL M	DN 19	3/4"	-12	BSP CS	1/2"	1/2-14
SRR-F12M12-BP04P	SSL F	DN 19	3/4"	-12	SSL M	DN 19	3/4"	-12	BSP CS	1/2"	1/2-14
SRR-F20M20-BP08P	SSL F	DN 31	1 1/4"	-20	SSL M	DN 31	1 1/4"	-20	BSP CS	1/2"	1/2-14
SRR-F20M20-BP12P	SSL F	DN 31	1 1/4"	-20	SSL M	DN 31	1 1/4"	-20	BSP CS	3/4"	3/4-14
SRR-F20M20-BP16P	SSL F	DN 31	1 1/4"	-20	SSL M	DN 31	1 1/4"	-20	BSP CS	1"	1-11
SRR-F24M24-BP04P	SSL F	DN 38	1 1/2"	-24	SSL M	DN 38	1 1/2"	-24	BSP CS	1/4"	1/4-19
SRR-F24M24-BP06P	SSL F	DN 38	1 1/2"	-24	SSL M	DN 38	1 1/2"	-24	BSP CS	3/8"	3/8-19
SRR-F24M24-BP08P	SSL F	DN 38	1 1/2"	-24	SSL M	DN 38	1 1/2"	-24	BSP CS	1/2"	1/2-14
SRR-F24M24-BP12P	SSL F	DN 38	1 1/2"	-24	SSL M	DN 38	1 1/2"	-24	BSP CS	3/4"	3/4-14
SRR-F24M32-BP08P	SSL F	DN 38	1 1/2"	-24	SSL M	DN 51	2"	-32	BSP CS	1/2"	1/2-14
SRR-F24M32-BP12P	SSL F	DN 38	1 1/2"	-24	SSL M	DN 51	2"	-32	BSP CS	3/4"	3/4-14
SRR-F32M32-BP04P	SSL F	DN 51	2"	-32	SSL M	DN 51	2"	-32	BSP CS	1/4"	1/4-19
SRR-F32M32-BP06P	SSL F	DN 51	2"	-32	SSL M	DN 51	2"	-32	BSP CS	3/8"	3/8-19
SRR-F32M32-BP08P	SSL F	DN 51	2"	-32	SSL M	DN 51	2"	-32	BSP CS	1/2"	1/2-14
SRR-F32M32-BP12P	SSL F	DN 51	2"	-32	SSL M	DN 51	2"	-32	BSP CS	3/4"	3/4-14
SRR-F32M32-BP16P	SSL F	DN 51	2"	-32	SSL M	DN 51	2"	-32	BSP CS	1"	1-11

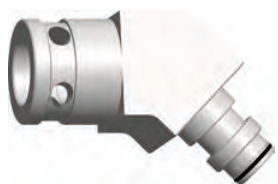

SR4-F-M

Super Rapid SL Female to
Super Rapid SL Male - 45°
SSLF-SSLM 45

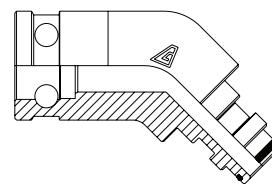

PRODUCT CODE	T1				T2			
	TYPE	NOMINAL BORE			TYPE	NOMINAL BORE		
		DN	INCH	DASH		DN	INCH	DASH
SR4-F08M08	SSL F	DN 12	1/2"	-08	SSL M	DN 12	1/2"	-08
SR4-F12M12	SSL F	DN 19	3/4"	-12	SSL M	DN 19	3/4"	-12
SR4-F16M16	SSL F	DN 25	1"	-16	SSL M	DN 25	1"	-16
SR4-F20M20	SSL F	DN 31	1 1/4"	-20	SSL M	DN 31	1 1/4"	-20
SR4-F24M24	SSL F	DN 38	1 1/2"	-24	SSL M	DN 38	1 1/2"	-24
SR4-F32M16	SSL F	DN 51	2"	-32	SSL M	DN 25	1"	-16
SR4-F32M32	SSL F	DN 51	2"	-32	SSL M	DN 51	2"	-32

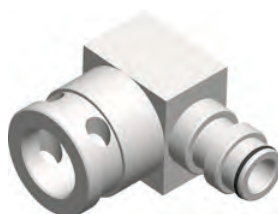

SR9-F-M

Super Rapid SL Female to
Super Rapid SL Male - 90°
SSLF-SSLM 90

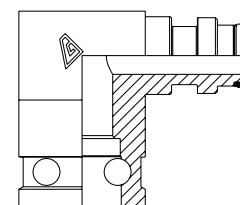

PRODUCT CODE	T1				T2			
	TYPE	NOMINAL BORE			TYPE	NOMINAL BORE		
		DN	INCH	DASH		DN	INCH	DASH
SR9-F12M12	SSL F	DN 19	3/4"	-12	SSL M	DN 19	3/4"	-12
SR9-F16M16	SSL F	DN 25	1"	-16	SSL M	DN 25	1"	-16
SR9-F20M20	SSL F	DN 31	1 1/4"	-20	SSL M	DN 31	1 1/4"	-20
SR9-F24M24	SSL F	DN 38	1 1/2"	-24	SSL M	DN 38	1 1/2"	-24
SR9-F32M32	SSL F	DN 51	2"	-32	SSL M	DN 51	2"	-32

SRR-RF-M

Rapid SL Female to
Super Rapid SL Male - Straight
SLF-SSLM

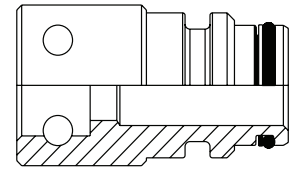

PRODUCT CODE	T1				T2			
	TYPE	NOMINAL BORE			TYPE	NOMINAL BORE		
		DN	INCH	DASH		DN	INCH	DASH
SRR-RF04M08	SL F	DN 06	1/4"	-04	SSL M	DN 12	1/2"	-08
SRR-RF06M08	SL F	DN 10	3/8"	-06	SSL M	DN 12	1/2"	-08
SRR-RF06M12	SL F	DN 10	3/8"	-06	SSL M	DN 19	3/4"	-12
SRR-RF06M16	SL F	DN 10	3/8"	-06	SSL M	DN 25	1"	-16
SRR-RF06M20	SL F	DN 10	3/8"	-06	SSL M	DN 31	1 1/4"	-20
SRR-RF06M24	SL F	DN 10	3/8"	-06	SSL M	DN 38	1 1/2"	-24
SRR-RF06M32	SL F	DN 10	3/8"	-06	SSL M	DN 51	2"	-32
SRR-RF08M08	SL F	DN 12	1/2"	-08	SSL M	DN 12	1/2"	-08

SR4-FS-M

Super Rapid SL Female Swivel to
Super Rapid SL Male - 45°
SSLF-SSLM 45

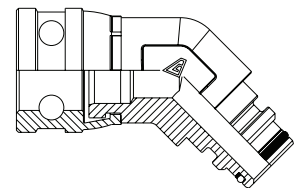

PRODUCT CODE	T1				T2			
	TYPE	NOMINAL BORE			TYPE	NOMINAL BORE		
		DN	INCH	DASH		DN	INCH	DASH
SR4-FS08M08	SSL FS	DN 12	1/2"	-08	SSL M	DN 12	1/2"	-08
SR4-FS12M12	SSL FS	DN 19	3/4"	-12	SSL M	DN 19	3/4"	-12
SR4-FS16M16	SSL FS	DN 25	1"	-16	SSL M	DN 25	1"	-16

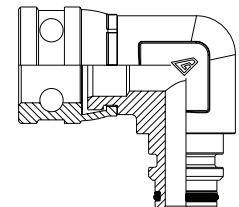

SR9-FS-M

Super Rapid SL Female Swivel to
Super Rapid SL Male - 90°
SSLFS-SSLM 90

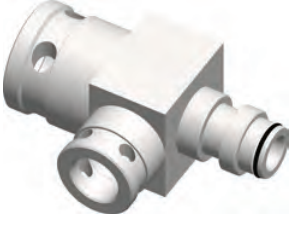

PRODUCT CODE	T1				T2			
	TYPE	NOMINAL BORE			TYPE	NOMINAL BORE		
		DN	INCH	DASH		DN	INCH	DASH
SR9-FS08M08	SSL FS	DN 12	1/2"	-08	SSL M	DN 12	1/2"	-08
SR9-FS12M12	SSL FS	DN 19	3/4"	-12	SSL M	DN 19	3/4"	-12
SR9-FS16M16	SSL FS	DN 25	1"	-16	SSL M	DN 25	1"	-16

SUPER RAPID STAPLE-LOCK ADAPTERS



SRT-F-M-F
 Super Rapid SL Female to
 Super Rapid SL Male Run Tee
 SSLF-SSLM-SSLF RT

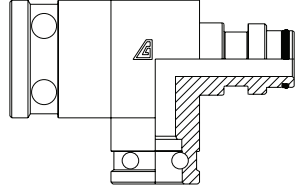

PRODUCT CODE	T1				T2				T3			
	TYPE	NOMINAL BORE			TYPE	NOMINAL BORE			TYPE	NOMINAL BORE		
		DN	INCH	DASH		DN	INCH	DASH		DN	INCH	DASH
SRT-F08M12F08	SSL F	DN 12	1/2"	-08	SSL M	DN 19	3/4"	-12	SSL F	DN 12	1/2"	-08
SRT-F12M12F08	SSL F	DN 19	3/4"	-12	SSL M	DN 19	3/4"	-12	SSL F	DN 12	1/2"	-08
SRT-F12M12F12	SSL F	DN 19	3/4"	-12	SSL M	DN 19	3/4"	-12	SSL F	DN 19	3/4"	-12
SRT-F16M16F12	SSL F	DN 25	1"	-16	SSL M	DN 25	1"	-16	SSL F	DN 19	3/4"	-12
SRT-F16M16F16	SSL F	DN 25	1"	-16	SSL M	DN 25	1"	-16	SSL M	DN 25	1"	-16
SRT-F16M20F16	SSL F	DN 25	1"	-16	SSL M	DN 31	1 1/4"	-20	SSL M	DN 25	1"	-16
SRT-F20M20F20	SSL F	DN 31	1 1/4"	-20	SSL M	DN 31	1 1/4"	-20	SSL F	DN 31	1 1/4"	-20
SRT-F24M24F24	SSL F	DN 38	1 1/2"	-24	SSL M	DN 38	1 1/2"	-24	SSL F	DN 38	1 1/2"	-24
SRT-F32M32F16	SSL F	DN 51	2"	-32	SSL M	DN 51	2"	-32	SSL M	DN 25	1"	-16
SRT-F32M32F24	SSL F	DN 51	2"	-32	SSL M	DN 51	2"	-32	SSL F	DN 38	1 1/2"	-24
SRT-F32M32F32	SSL F	DN 51	2"	-32	SSL M	DN 51	2"	-32	SSL F	DN 51	2"	-32

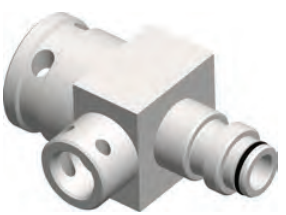

SRT-F-M-RF
 Super Rapid SL Female to
 Super Rapid SL Male to
 Rapid Female Run Tee
 SSLF-SSLM-SLF - RT

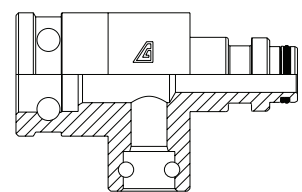

PRODUCT CODE	T1				T2				T3			
	TYPE	NOMINAL BORE			TYPE	NOMINAL BORE			TYPE	NOMINAL BORE		
		DN	INCH	DASH		DN	INCH	DASH		DN	INCH	DASH
SRT-F12M12RF06	SSL F	DN 19	3/4"	-12	SSL M	DN 19	3/4"	-12	SL F	DN 10	3/8"	-06
SRT-F16M16RF06	SSL F	DN 25	1"	-16	SSL M	DN 25	1"	-16	SL F	DN 10	3/8"	-06
SRT-F16M16RF08	SSL F	DN 25	1"	-16	SSL M	DN 25	1"	-16	SL F	DN 12	1/2"	-08
SRT-F32M32RF06	SSL F	DN 51	2"	-32	SSL M	DN 51	2"	-32	SL F	DN 10	3/8"	-06
SRT-F32M32RF08	SSL F	DN 51	2"	-32	SSL M	DN 51	2"	-32	SL F	DN 12	1/2"	-08

SRTA-F-BPMCS

Super Rapid SL Female to
BSP Male Captive Seal - Straight
SSLF-BPMCS

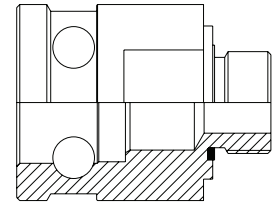

PRODUCT CODE	T1				T2		
	TYPE	NOMINAL BORE			TYPE	NOMINAL BORE	
		DN	INCH	DASH		INCH	TPI
TPI	SSL F	DN 12	1/2"	-08	BSP M	1/2"	1/2-14
SRTA-F12BPMCS12	SSL F	DN 19	3/4"	-12	BSP M	3/4"	3/4-14
SRTA-F12BPMCS16	SSL F	DN 19	3/4"	-12	BSP M	1"	1-11
SRTA-F12BPMCS20	SSL F	DN 19	3/4"	-12	BSP M	1 1/4"	1 1/4-11
SRTA-F12BPMCS24	SSL F	DN 19	3/4"	-12	BSP M	1 1/2"	1 1/2-11
SRTA-F16BPMCS16	SSL F	DN 25	1"	-16	BSP M	1"	1-11
SRTA-F20BPMCS16	SSL F	DN 31	1 1/4"	-20	BSP M	1"	1-11
SRTA-F20BPMCS20	SSL F	DN 31	1 1/4"	-20	BSP M	1 1/4"	1 1/4-11
SRTA-F20BPMCS24	SSL F	DN 31	1 1/4"	-20	BSP M	1 1/2"	1 1/2-11
SRTA-F24BPMCS20	SSL F	DN 38	1 1/2"	-24	BSP M	1 1/4"	1 1/4-11
SRTA-F24BPMCS24	SSL F	DN 38	1 1/2"	-24	BSP M	1 1/2"	1 1/2-11
SRTA-F32BPMCS16	SSL F	DN 51	2"	-32	BSP M	1"	1-11
SRTA-F32BPMCS20	SSL F	DN 51	2"	-32	BSP M	1 1/4"	1 1/4-11
SRTA-F32BPMCS24	SSL F	DN 51	2"	-32	BSP M	1 1/2"	1 1/2-11

SRTA-F-BPMCO

Super Rapid SL Female to
BSP Male Captive O-Ring - Straight
SSLF-BPMCO

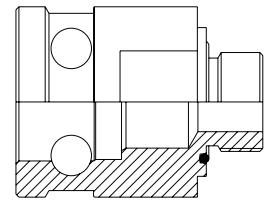

PRODUCT CODE	T1				T2		
	TYPE	NOMINAL BORE			TYPE	NOMINAL BORE	
		DN	INCH	DASH		INCH	TPI
SRTA-F20BPMCO32	SSL F	DN 31	1 1/4"	-20	BSP M	2"	2-11
SRTA-F24BPMCO32	SSL F	DN 38	1 1/2"	-24	BSP M	2"	2-11
SRTA-F32BPMCO32	SSL F	DN 51	2"	-32	BSP M	2"	2-11

SRTA-FS-BPMIH

Super Rapid SL Female Swivel to
BSP Male Internal Hex - Straight
SSLFS-BPMIH

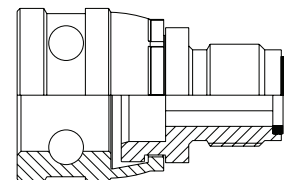

PRODUCT CODE	T1				T2		
	TYPE	NOMINAL BORE			TYPE	NOMINAL BORE	
		DN	INCH	DASH		INCH	TPI
SRTA-FS08BPMIH	SSL FS	DN 12	1/2"	-08	BSP M	1/2"	1/2-14

SUPER RAPID STAPLE-LOCK ADAPTERS**SRR-F-FL6K**

Super Rapid SL Female to
SAE Flange Code 62 - Straight
SSLF-FL6K

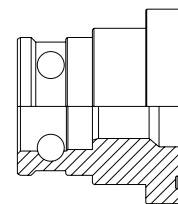

PRODUCT CODE	T1				T2		
	TYPE	NOMINAL BORE			TYPE	FLANGE	
		DN	INCH	DASH		INCH	DASH
SRR-F12FL6K16	SSL F	DN 19	3/4"	-12	SAE FL62	1"	-16
SRR-F12FL6K20	SSL F	DN 19	3/4"	-12	SAE FL62	1 1/4"	-20
SRR-F12FL6K24	SSL F	DN 19	3/4"	-12	SAE FL62	1 1/2"	-24
SRR-F16FL6K24	SSL F	DN 25	1"	-16	SAE FL62	1 1/2"	-24
SRR-F20FL6K20	SSL F	DN 31	1 1/4"	-20	SAE FL62	1 1/4"	-20
SRR-F20FL6K24	SSL F	DN 31	1 1/4"	-20	SAE FL62	1 1/2"	-24
SRR-F24FL6K32	SSL F	DN 38	1 1/2"	-24	SAE FL62	2"	-32
SRR-F32FL6K20	SSL F	DN 51	2"	-32	SAE FL62	1 1/4"	-20
SRR-F32FL6K32	SSL F	DN 51	2"	-32	SAE FL62	2"	-32

**SRTA-M-BPMCS**

Super Rapid SL Male to
BSP Male Captive Seal - Straight
SSLM-BPMCS

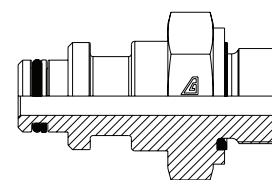

PRODUCT CODE	T1				T2		
	TYPE	NOMINAL BORE			TYPE	THREAD	
		DN	INCH	DASH		INCH	TPI
SRTA-M08BPMCS08	SSL M	DN 12	1/2"	-08	BSP M	1/2"	1/2-14
SRTA-M12BPMCS12	SSL M	DN 19	3/4"	-12	BSP M	3/4"	3/4-14
SRTA-M12BPMCS24	SSL M	DN 19	3/4"	-12	BSP M	1 1/2"	1 1/2-11
SRTA-M16BPMCS16	SSL M	DN 25	1"	-16	BSP M	1"	1-11
SRTA-M16BPMCS20	SSL M	DN 25	1"	-16	BSP M	1 1/4"	1 1/4-11
SRTA-M20BPMCS16	SSL M	DN 31	1 1/4"	-20	BSP M	1"	1-11
SRTA-M20BPMCS20	SSL M	DN 31	1 1/4"	-20	BSP M	1 1/4"	1 1/4-11
SRTA-M20BPMCS24	SSL M	DN 31	1 1/4"	-20	BSP M	1 1/2"	1 1/2-11
SRTA-M24BPMCS16	SSL M	DN 38	1 1/2"	-24	BSP M	1"	1-11
SRTA-M24BPMCS20	SSL M	DN 38	1 1/2"	-24	BSP M	1 1/4"	1 1/4-11
SRTA-M24BPMCS24	SSL M	DN 38	1 1/2"	-24	BSP M	1 1/2"	1 1/2-11
SRTA-M32BPMCS16	SSL M	DN 51	2"	-32	BSP M	1"	1-11
SRTA-M32BPMCS24	SSL M	DN 51	2"	-32	BSP M	1 1/2"	1 1/2-11

**SRTA-M-BPMCO**

Super Rapid SL Male to
BSP Male Captive O-Ring - Straight
SSLM-BPMCO

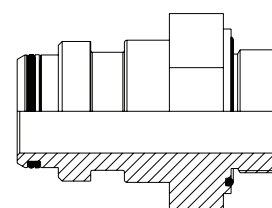

PRODUCT CODE	T1				T2		
	TYPE	NOMINAL BORE			TYPE	THREAD	
		DN	INCH	DASH		INCH	TPI
SRTA-M24BPMCO32	SSL M	DN 38	1 1/2"	-24	BSP M	2"	2-11
SRTA-M32BPMCO32	SSL M	DN 51	2"	-32	BSP M	2"	2-11



SRR-M-FL6K
 Super Rapid SL Male to
 SAE Flange Code 62 - Straight
 SSLM-FL6K

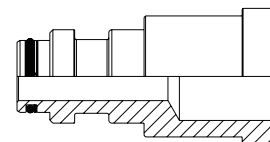

PRODUCT CODE	T1				T2		
	TYPE	NOMINAL BORE			TYPE	FLANGE	
		DN	INCH	DASH		INCH	DASH
SRR-M12FL6K16	SSL M	DN 19	3/4"	-12	SAE FL62	1"	-16
SRR-M12FL6K24	SSL M	DN 19	3/4"	-12	SAE FL62	1 1/2"	-24
SRR-M12FL6K32	SSL M	DN 19	3/4"	-12	SAE FL62	2"	-32
SRR-M20FL6K24	SSL M	DN 31	1 1/4"	-20	SAE FL62	1 1/2"	-24
SRR-M24FL6K24	SSL M	DN 38	1 1/2"	-24	SAE FL62	1 1/2"	-24
SRR-M24FL6K24	SSL M	DN 38	1 1/2"	-24	SAE FL62	2"	-32
SRR-M32FL6K32	SSL M	DN 51	2"	-32	SAE FL62	2"	-32



SR3-F-M-SE
 Super Rapid SL Female to
 Super Rapid SL Male - 30°
 Solid One Piece Swept Elbow
 SSLF-SSLM 30 SE

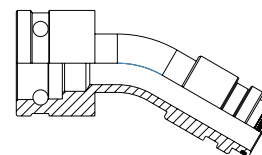

PRODUCT CODE	T1				T2			
	TYPE	NOMINAL BORE			TYPE	NOMINAL BORE		
		DN	INCH	DASH		DN	INCH	DASH
SR3-F12M12-SE	SSL F	DN 19	3/4"	-12	SSL M	DN 19	3/4"	-12
SR3-F16M16-SE	SSL F	DN 25	1"	-16	SSL M	DN 25	1"	-16
SR3-F20M20-SE	SSL F	DN 31	1 1/4"	-20	SSL M	DN 31	1 1/4"	-20
SR3-F24M24-SE	SSL F	DN 38	1 1/2"	-24	SSL M	DN 38	1 1/2"	-24
SR3-F32M32-SE	SSL F	DN 51	2"	-32	SSL M	DN 51	2"	-32

Staple pin holes orientation to be specified



SR4-F-M-SE
 Super Rapid SL Female to
 Super Rapid SL Male - 45°
 Solid One Piece Swept Elbow
 SSLF-SSLM 45 SE

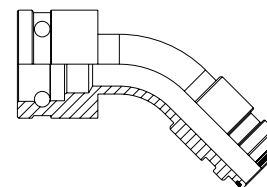

PRODUCT CODE	T1				T2			
	TYPE	NOMINAL BORE			TYPE	NOMINAL BORE		
		DN	INCH	DASH		DN	INCH	DASH
SR4-F12M12-SE	SSL F	DN 19	3/4"	-12	SSL M	DN 19	3/4"	-12
SR4-F16M16-SE	SSL F	DN 25	1"	-16	SSL M	DN 25	1"	-16
SR4-F20M20-SE	SSL F	DN 31	1 1/4"	-20	SSL M	DN 31	1 1/4"	-20
SR4-F24M24-SE	SSL F	DN 38	1 1/2"	-24	SSL M	DN 38	1 1/2"	-24
SR4-F32M32-SE	SSL F	DN 51	2"	-32	SSL M	DN 51	2"	-32

Staple pin holes orientation to be specified

SUPER RAPID STAPLE-LOCK ADAPTERS



SR9-F-M-SE
 Super Rapid SL Female to
 Super Rapid SL Male - 90°
 Solid One Piece Swept Elbow
 SSLF-SSLM 90 SE

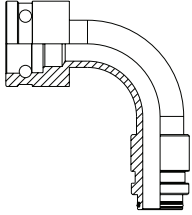

PRODUCT CODE	T1				T2			
	TYPE	NOMINAL BORE			TYPE	NOMINAL BORE		
		DN	INCH	DASH		DN	INCH	DASH
SR9-F12M12-SE	SSL F	DN 20	3/4"	-12	SSL M	DN 20	3/4"	-12
SR9-F16M16-SE	SSL F	DN 25	1"	-16	SSL M	DN 25	1"	-16
SR9-F20M20-SE	SSL F	DN 31	1 1/4"	-20	SSL M	DN 31	1 1/4"	-20
SR9-F24M24-SE	SSL F	DN 38	1 1/2"	-24	SSL M	DN 38	1 1/2"	-24
SR9-F24M32-SE	SSL F	DN 38	1 1/2"	-24	SSL M	DN 51	2"	-32
SR9-F32M32-SE	SSL F	DN 51	2"	-32	SSL M	DN 51	2"	-32

Staple pin holes orientation to be specified



SR4-F-SE
 Super Rapid SL Female to
 Super Rapid SL Female - 45°
 Solid One Piece Swept Elbow
 SSLF-SSLF 45 SE

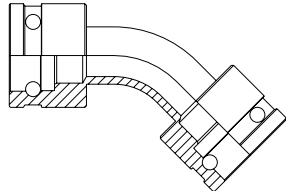

PRODUCT CODE	T1				T2			
	TYPE	NOMINAL BORE			TYPE	NOMINAL BORE		
		DN	INCH	DASH		DN	INCH	DASH
SR4-F16-SE	SSL F	DN 25	1"	-16	SSL F	DN 25	1"	-16
SR4-F20-SE	SSL F	DN 31	1 1/4"	-20	SSL F	DN 31	1 1/4"	-20
SR4-F24-SE	SSL F	DN 38	1 1/2"	-24	SSL F	DN 38	1 1/2"	-24
SR4-F32-SE	SSL F	DN 51	2"	-32	SSL F	DN 51	2"	-32

Staple pin holes orientation to be specified



SR9-F-SE
 Super Rapid SL Female to
 Super Rapid SL Female - 90°
 Solid One Piece Swept Elbow
 SSLF-SSLF 90 SE

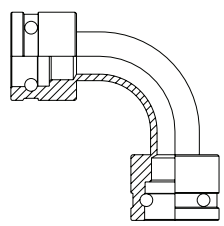

PRODUCT CODE	T1				T2			
	TYPE	NOMINAL BORE			TYPE	NOMINAL BORE		
		DN	INCH	DASH		DN	INCH	DASH
SR9-F16-SE	SSL F	DN 25	1"	-16	SSL F	DN 25	1"	-16
SR9-F20-SE	SSL F	DN 31	1 1/4"	-20	SSL F	DN 31	1 1/4"	-20
SR9-F24-SE	SSL F	DN 38	1 1/2"	-24	SSL F	DN 38	1 1/2"	-24
SR9-F32-SE	SSL F	DN 51	2"	-32	SSL F	DN 51	2"	-32

Staple pin holes orientation to be specified



CC-F
Compact Female End Cap
CP F END CAP

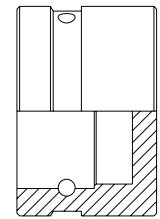

PRODUCT CODE	T1			
	TYPE	NOMINAL BORE		
		DN	INCH	DASH
CC-F20	CP F	DN 31	1 1/4"	-20
CC-F24	CP F	DN 38	1 1/2"	-24
CC-F32	CP F	DN 51	2"	-32
CC-F40	CP F	DN 63	2 1/2"	-40



CP-M
Compact Male Plug
CP M PLUG

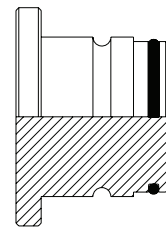

PRODUCT CODE	T1			
	TYPE	NOMINAL BORE		
		DN	INCH	DASH
CP-M20	CP M	DN 31	1 1/4"	-20
CP-M24	CP M	DN 38	1 1/2"	-24
CP-M32	CP M	DN 51	2"	-32
CP-M40	CP M	DN 63	2 1/2"	-40



CJ-F
Compact Female to Compact Female - Straight
CPF-CPF

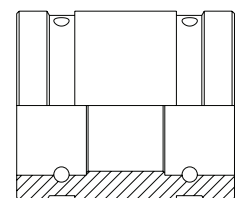

PRODUCT CODE	T1				T2			
	TYPE	NOMINAL BORE			TYPE	NOMINAL BORE		
		DN	INCH	DASH		DN	INCH	DASH
CJ-F20	CP F	DN 31	1 1/4"	-20	CP F	DN 31	1 1/4"	-20
CJ-F24	CP F	DN 38	1 1/2"	-24	CP F	DN 38	1 1/2"	-24
CJ-F32	CP F	DN 51	2"	-32	CP F	DN 51	2"	-32
CJ-F40	CP F	DN 63	2 1/2"	-40	CP F	DN 63	2 1/2"	-40



CN-M
Compact Male to Compact Male - Straight
CPM-CPM

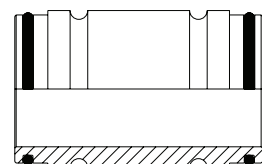

PRODUCT CODE	T1				T2			
	TYPE	NOMINAL BORE			TYPE	NOMINAL BORE		
		DN	INCH	DASH		DN	INCH	DASH
CN-M20	CP M	DN 31	1 1/4"	-20	CP M	DN 31	1 1/4"	-20
CN-M24	CP M	DN 38	1 1/2"	-24	CP M	DN 38	1 1/2"	-24
CN-M32	CP M	DN 51	2"	-32	CP M	DN 51	2"	-32
CN-M40	CP M	DN 63	2 1/2"	-40	CP M	DN 63	2 1/2"	-40

COMPACT ADAPTERS



CN-M-RM
Compact Male to Rapid SL Male - Straight
CPM-SLM

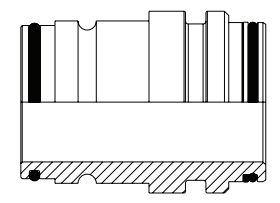

PRODUCT CODE	T1				T2			
	TYPE	NOMINAL BORE			TYPE	NOMINAL BORE		
		DN	INCH	DASH		DN	INCH	DASH
CR-M20RM06	CP M	DN 31	1 1/4"	-20	SL M	DN 10	3/8"	-06
CR-M24RM20	CP M	DN 38	1 1/2"	-24	SL M	DN 31	1 1/4"	-20
CR-M24RM24	CP M	DN 38	1 1/2"	-24	SL M	DN 38	1 1/2"	-24
CR-M32RM20	CP M	DN 51	2"	-32	SL M	DN 31	1 1/4"	-20
CR-M32RM32	CP M	DN 51	2"	-32	SL M	DN 51	2"	-32



CR-F-M
Compact Female to Compact Male - Straight
CPF-CPM

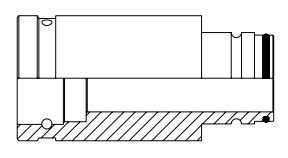

PRODUCT CODE	T1				T2			
	TYPE	NOMINAL BORE			TYPE	NOMINAL BORE		
		DN	INCH	DASH		DN	INCH	DASH
CR-F24M24	CP F	DN 38	1 1/2"	-24	CP M	DN 38	1 1/2"	-24
CR-F24M32	CP F	DN 38	1 1/2"	-24	CP M	DN 51	2"	-32
CR-F32M32	CP F	DN 51	2"	-32	CP M	DN 51	2"	-32
CR-F32M40	CP F	DN 51	2"	-32	CP M	DN 63	2 1/2"	-40
CR-F40M40	CP F	DN 63	2 1/2"	-40	CP M	DN 63	2 1/2"	-40



CR-F-M x BP
Compact Female to Compact Male x BSP Port - Straight
CPF-CPM x BP

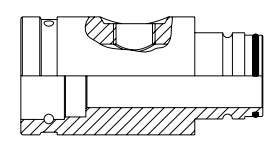

PRODUCT CODE	T1				T2				P1		
	TYPE	NOMINAL BORE			TYPE	NOMINAL BORE			TYPE	THREAD	
		DN	INCH	DASH		DN	INCH	DASH		INCH	TPI
CR-F24M24-BP12P	CP F	DN 38	1 1/2"	-24	CP M	DN 38	1 1/2"	-24	BSP F	3/4"	3/4-14
CR-F32M32-BP08P	CP F	DN 51	2"	-32	CP M	DN 51	2"	-32	BSP F	1/2"	1/2-14
CR-F32M32-BP12P	CP F	DN 51	2"	-32	CP M	DN 51	2"	-32	BSP F	3/4"	3/4-14
CR-F32M32-BP16P	CP F	DN 51	2"	-32	CP M	DN 51	2"	-32	BSP F	1"	1-11
CR-F32M32-BP20P	CP F	DN 51	2"	-32	CP M	DN 51	2"	-32	BSP F	1 1/4"	1 1/4-11
CR-F32M40-BP16P	CP F	DN 51	2"	-32	CP M	DN 63	2 1/2"	-40	BSP F	1"	1-11
CR-F40M40-BP08P	CP F	DN 63	2 1/2"	-40	CP M	DN 63	2 1/2"	-40	BSP F	1/2"	1/2-14
CR-F40M40-BP12P	CP F	DN 63	2 1/2"	-40	CP M	DN 63	2 1/2"	-40	BSP F	3/4"	3/4-14
CR-F40M40-BP16P	CP F	DN 63	2 1/2"	-40	CP M	DN 63	2 1/2"	-40	BSP F	1"	1-11

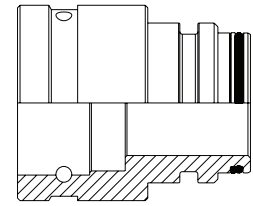
CR-F-RM
**Compact Female to Rapid SL Male - Straight
CPF-SLM**

PRODUCT CODE	T1				T2			
	TYPE	NOMINAL BORE			TYPE	NOMINAL BORE		
		DN	INCH	DASH		DN	INCH	DASH
CR-F24RM32	CP F	DN 38	1 1/2"	-24	SL M	DN 51	2"	-32
CR-F32RM16	CP F	DN 51	2"	-32	SL M	DN 25	1"	-16
CR-F32RM20	CP F	DN 51	2"	-32	SL M	DN 31	1 1/4"	-20

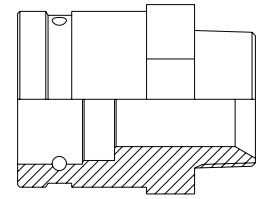
CTA-F-BTM
**Compact Female to BSPT Male - Straight
CPF-BTM**

PRODUCT CODE	T1				T2		
	TYPE	NOMINAL BORE			TYPE	NOMINAL BORE	
		DN	INCH	DASH		INCH	TPI
CTA-F20BTM20	CP F	DN 31	1 1/4"	-20	BSPT M	1 1/4"	1 1/4-11
CTA-F24BTM24	CP F	DN 38	1 1/2"	-24	BSPT M	1 1/2"	1 1/2-11
CTA-F32BTM32	CP F	DN 51	2"	-32	BSPT M	2"	2-11

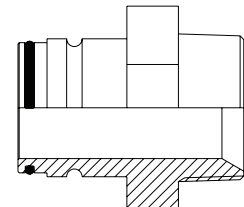
CTA-M-BTM
**Compact Male to BSPT Male - Straight
CPM-BTM**

PRODUCT CODE	T1				T2		
	TYPE	NOMINAL BORE			TYPE	NOMINAL BORE	
		DN	INCH	DASH		INCH	TPI
CTA-M24BTM24	CP M	DN 38	1 1/2"	-24	BSPT M	1 1/2"	1 1/2-11
CTA-M32BTM32	CP M	DN 51	2"	-32	BSPT M	2"	2-11

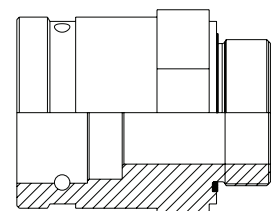

CTA-F-BPMCS
**Compact Female to
BSP Male Captive Seal - Straight
CPF-BPMCS**

PRODUCT CODE	T1				T2		
	TYPE	NOMINAL BORE			TYPE	NOMINAL BORE	
		DN	INCH	DASH		INCH	TPI
CTA-F24BPMCS20	CP F	DN 38	1 1/2"	-24	BSP M	1 1/4"	1 1/4-11
CTA-F24BPMCS24	CP F	DN 38	1 1/2"	-24	BSP M	1 1/2"	1 1/2-11
CTA-F32BPMCS16	CP F	DN 51	2"	-32	BSP M	1"	1-11
CTA-F32BPMCS24	CP F	DN 51	2"	-32	BSP M	1 1/2"	1 1/2-11

COMPACT ADAPTERS

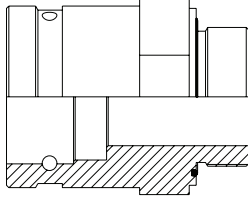

CTA-F-BPMCO
 Compact Female to
 BSP Male Captive O-Ring - Straight
 CPF-BPMCO



PRODUCT CODE	T1				T2		
	TYPE	NOMINAL BORE			TYPE	THREAD	
		DN	INCH	DASH		INCH	TPI
CTA-F32BPMCO32	CP F	DN 51	2"	-32	BSP CO M	2"	2-11
CTA-F40BPMCO32	CP F	DN 63	2 1/2"	-40	BSP CO M	2"	2-11



CTA-M-BPMCS
 Compact Male to
 BSP Male Captive Seal - Straight
 CPM-BPMCS

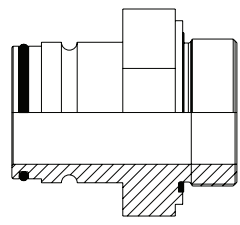

PRODUCT CODE	T1				T2		
	TYPE	NOMINAL BORE			TYPE	THREAD	
		DN	INCH	DASH		INCH	TPI
CTA-M24BPMCS24	CP M	DN 38	1 1/2"	-24	BSP M	1 1/2"	1 1/2-11
CTA-M32BPMCS16	CP M	DN 51	2"	-32	BSP M	1"	1-11
CTA-M32BPMCS20	CP M	DN 51	2"	-32	BSP M	1 1/4"	1 1/4-11
CTA-M32BPMCS24	CP M	DN 51	2"	-32	BSP M	1 1/2"	1 1/2-11



CTA-M-BPMCO
 Compact Male to
 BSP Male Captive O-Ring - Straight
 CPM-BPMCO

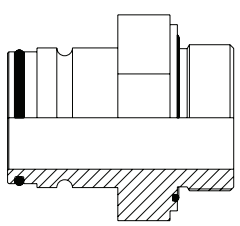

PRODUCT CODE	T1				T2		
	TYPE	NOMINAL BORE			TYPE	THREAD	
		DN	INCH	DASH		INCH	TPI
CTA-M32BPMCO32	CP M	DN 51	2"	-32	BSP M	2"	2-11
CTA-M40BPMCO32	CP M	DN 63	2 1/2"	-40	BSP M	2"	2-11

BHRR-F-M

Bulkhead Rapid SL Female to
Rapid SL Male - Straight

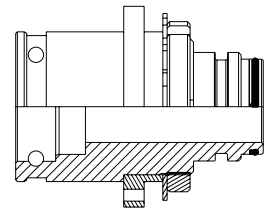
BHSLF-SLM

PRODUCT CODE	T1				T2			
	TYPE	NOMINAL BORE			TYPE	NOMINAL BORE		
		DN	INCH	DASH		DN	INCH	DASH
BHRR-F16M16	BH SL F	DN 25	1"	-16	SL M	DN 25	1"	-16
BHRR-F24M24	BH SL F	DN 38	1 1/2"	-24	SL M	DN 38	1 1/2"	-24
BHRR-F32M32	BH SL F	DN 51	2"	-32	SL M	DN 51	2"	-32
BHRR-F40M40	BH SL F	DN 63	2 1/2"	-40	SL M	DN 63	2 1/2"	-40
BHRR-F48M48	BH SL F	DN 75	3"	-48	SL M	DN 75	3"	-48

BHRR-F-M x BP

Bulkhead Rapid SL Female to
Rapid SL Male x BSP Port - Straight

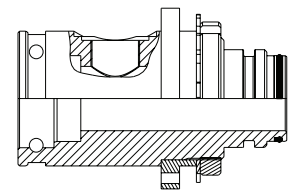
BHSLF-SLM x BP

PRODUCT CODE	T1				T2				P1		
	TYPE	NOMINAL BORE			TYPE	NOMINAL BORE			TYPE	THREAD	
		DN	INCH	DASH		DN	INCH	DASH		INCH	TPI
BHRR-F32M32-P16	BH SL F	DN 51	2"	-32	SL M	DN 51	2"	-32	BSP CS	1"	1-11
BHRR-F40M40-P06	BH SL F	DN 63	2 1/2"	-40	SL M	DN 63	2 1/2"	-40	BSP CS	3/8"	3/8-19
BHRR-F40M40-P08	BH SL F	DN 63	2 1/2"	-40	SL M	DN 63	2 1/2"	-40	BSP CS	1/2"	1/2-14
BHRR-F40M40-P16	BH SL F	DN 63	2 1/2"	-40	SL M	DN 63	2 1/2"	-40	BSP CS	1"	1-11

BHR4-F-M-SE

Bulkhead Rapid SL Female to
Rapid SL Male - 45°
Solid One Piece Swept Elbow

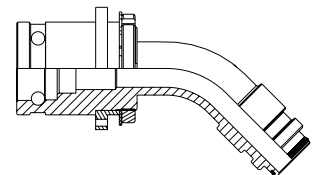
BHSLF-SLM 45-SE

PRODUCT CODE	T1				T2			
	TYPE	NOMINAL BORE			TYPE	NOMINAL BORE		
		DN	INCH	DASH		DN	INCH	DASH
BHR4-F12M12-SE	BH SL F	DN 20	3/4"	-12	SL M	DN 20	3/4"	-12
BHR4-F32M32-SE	BH SL F	DN 51	2"	-32	SL M	DN 51	2"	-32

BHR9-F-M-SE

Bulkhead Rapid SL Female to
Rapid SL Male - 90°
Solid One Piece Swept Elbow

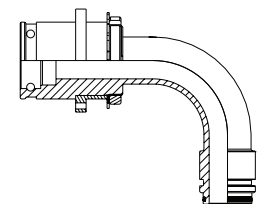
BHSLF-SLM 90-SE

PRODUCT CODE	T1				T2			
	TYPE	NOMINAL BORE			TYPE	NOMINAL BORE		
		DN	INCH	DASH		DN	INCH	DASH
BHR9-F16M16-SE	BH SL F	DN 25	1"	-16	SL M	DN 25	1"	-16
BHR9-F24M24-SE	BH SL F	DN 38	1 1/2"	-24	SL M	DN 38	1 1/2"	-24
BHR9-F32M32-SE	BH SL F	DN 51	2"	-32	SL M	DN 51	2"	-32

BULKHEAD ADAPTERS



BHRJ-F-F
Bulkhead Rapid SL Female to Rapid SL Female - Straight
BHSLF-SLF

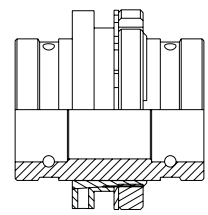

PRODUCT CODE	T1				T2			
	TYPE	NOMINAL BORE			TYPE	NOMINAL BORE		
		DN	INCH	DASH		DN	INCH	DASH
BHRJ-F04	BH SL F	DN 06	1/4"	-04	SL F	DN 06	1/4"	-04
BHRJ-F06	BH SL F	DN 10	3/8"	-06	SL F	DN 10	3/8"	-06
BHRJ-F08	BH SL F	DN 12	1/2"	-08	SL F	DN 12	1/2"	-08
BHRJ-F12	BH SL F	DN 19	3/4"	-12	SL F	DN 19	3/4"	-12
BHRJ-F16	BH SL F	DN 25	1"	-16	SL F	DN 25	1"	-16
BHRJ-F20	BH SL F	DN 31	1 1/4"	-20	SL F	DN 31	1 1/4"	-20
BHRJ-F24	BH SL F	DN 38	1 1/2"	-24	SL F	DN 38	1 1/2"	-24
BHRJ-F32	BH SL F	DN 51	2"	-32	SL F	DN 51	2"	-32
BHRJ-F40	BH SL F	DN 63	2 1/2"	-40	SL F	DN 63	2 1/2"	-40



BHRJ-F-F x BP
Bulkhead Rapid SL Female to Rapid SL Female x BSP Port - Straight
BHSLF-SLF x BP

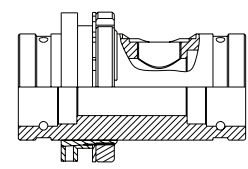

PRODUCT CODE	T1				T2				P1		
	TYPE	NOMINAL BORE			TYPE	NOMINAL BORE			TYPE	THREAD	
		DN	INCH	DASH		DN	INCH	DASH		INCH	TPI
BHRJ-F32-BP16P	BH SL F	DN 51	2"	-32	SL F	DN 51	2"	-32	BSP F	1"	1-11
BHRJ-F40-BP06P	BH SL F	DN 63	2 1/2"	-40	SL F	DN 63	2 1/2"	-40	BSP F	3/8"	3/8-19

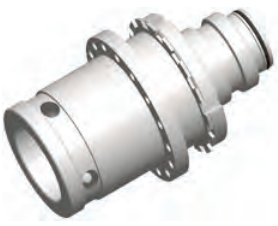

BHSRR-F-M
Bulkhead Super Rapid SL Female to Super Rapid SL Male - Straight
BHSSLF-SSLM

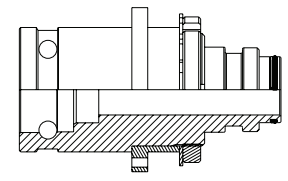

PRODUCT CODE	T1				T2			
	TYPE	NOMINAL BORE			TYPE	NOMINAL BORE		
		DN	INCH	DASH		DN	INCH	DASH
BHSRR-F12M12	BH SSL F	DN 19	3/4"	-12	SSL M	DN 19	3/4"	-12
BHSRR-F16M16	BH SSL F	DN 25	1"	-16	SSL M	DN 25	1"	-16
BHSRR-F20M20	BH SSL F	DN 38	1 1/2"	-24	SSL M	DN 38	1 1/2"	-24
BHSRR-F24M24	BH SSL F	DN 51	2"	-32	SSL M	DN 51	2"	-32
BHSRR-F32M32	BH SSL F	DN 63	2 1/2"	-40	SSL M	DN 63	2 1/2"	-40

BHSRR-F-M x BPCS

Bulkhead Super Rapid SL Female to Super Rapid SL Male x BSP CS Port - Straight
BHSSLF-SSLM x BPCS

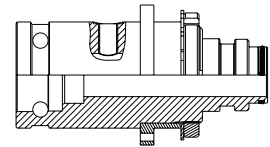

PRODUCT CODE	T1				T2				P1		
	TYPE	NOMINAL BORE			TYPE	NOMINAL BORE			TYPE	THREAD	
		DN	INCH	DASH		DN	INCH	DASH		INCH	TPI
BHSRR-F16M16-P04	BH SSL F	DN 25	1"	-16	SSL M	DN 25	1"	-16	BSP CS	1/4"	1/4-19
BHSRR-F16M16-P06	BH SSL F	DN 25	1"	-16	SSL M	DN 25	1"	-16	BSP CS	3/8"	3/8-19
BHSRR-F16M16-P08	BH SSL F	DN 25	1"	-16	SSL M	DN 25	1"	-16	BSP CS	1/2"	1/2-14
BHSRR-F20M20-P04	BH SSL F	DN 31	1 1/4"	-20	SSL M	DN 31	1 1/4"	-20	BSP CS	1/4"	1/4-19
BHSRR-F20M20-P06	BH SSL F	DN 31	1 1/4"	-20	SSL M	DN 31	1 1/4"	-20	BSP CS	3/8"	3/8-19
BHSRR-F20M20-P08	BH SSL F	DN 31	1 1/4"	-20	SSL M	DN 31	1 1/4"	-20	BSP CS	1/2"	1/2-14
BHSRR-F24M24-P04	BH SSL F	DN 38	1 1/2"	-24	SSL M	DN 38	1 1/2"	-24	BSP CS	1/4"	1/4-19
BHSRR-F24M24-P06	BH SSL F	DN 38	1 1/2"	-24	SSL M	DN 38	1 1/2"	-24	BSP CS	3/8"	3/8-19
BHSRR-F24M24-P08	BH SSL F	DN 38	1 1/2"	-24	SSL M	DN 38	1 1/2"	-24	BSP CS	1/2"	1/2-14
BHSRR-F32M23-P04	BH SSL F	DN 51	2"	-32	SSL M	DN 51	2"	-32	BSP CS	1/4"	1/4-19
BHSRR-F32M23-P06	BH SSL F	DN 51	2"	-32	SSL M	DN 51	2"	-32	BSP CS	3/8"	3/8-19
BHSRR-F32M23-P08	BH SSL F	DN 51	2"	-32	SSL M	DN 51	2"	-32	BSP CS	1/2"	1/2-14
BHSRR-F32M23-P12	BH SSL F	DN 51	2"	-32	SSL M	DN 51	2"	-32	BSP CS	3/4"	3/4-14

BHSR9-F-M-SE

Bulkhead Super Rapid SL Female to Super Rapid SL Male - 90° Solid One Piece Swept Elbow
BHSSLF-SSLM 90-SE

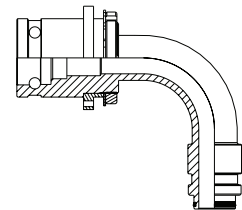

PRODUCT CODE	T1				T2			
	TYPE	NOMINAL BORE			TYPE	NOMINAL BORE		
		DN	INCH	DASH		DN	INCH	DASH
BHSR9-F12M12-SE	BH SSL F	DN 20	3/4"	-12	SSL M	DN 20	3/4"	-12
BHSR9-F16M16-SE	BH SSL F	DN 25	1"	-16	SSL M	DN 25	1"	-16
BHSR9-F24M24-SE	BH SSL F	DN 38	1 1/2"	-24	SSL M	DN 38	1 1/2"	-24
BHSR9-F32M32-SE	BH SSL F	DN 51	2"	-32	SSL M	DN 51	2"	-32

BHSRJ-F-F

Bulkhead Super Rapid SL Female to Super Rapid SL Female - Straight
BHSSLF-SSLF

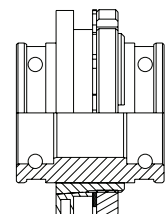

PRODUCT CODE	T1				T2			
	TYPE	NOMINAL BORE			TYPE	NOMINAL BORE		
		DN	INCH	DASH		DN	INCH	DASH
BHSRJ-F08	BH SSL F	DN 12	1/2"	-08	SSL F	DN 12	1/2"	-08
BHSRJ-F12	BH SSL F	DN 19	3/4"	-12	SSL F	DN 19	3/4"	-12
BHSRJ-F16	BH SSL F	DN 25	1"	-16	SSL F	DN 25	1"	-16
BHSRJ-F20	BH SSL F	DN 31	1 1/4"	-20	SSL F	DN 31	1 1/4"	-20
BHSRJ-F24	BH SSL F	DN 38	1 1/2"	-24	SSL F	DN 38	1 1/2"	-24
BHSRJ-F32	BH SSL F	DN 51	2"	-32	SSL F	DN 51	2"	-32

BULKHEAD ADAPTERS



BHSRJ-F-F x BPCS

Bulkhead Super Rapid SL Female to Super Rapid SL Female x BSP CS Port - Straight
BHSSLF-SSLF x BPCS

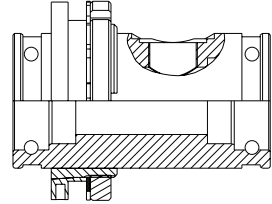

PRODUCT CODE	T1				T2				P1		
	TYPE	NOMINAL BORE			TYPE	NOMINAL BORE			TYPE	THREAD	
		DN	INCH	DASH		DN	INCH	DASH		INCH	TPI
BHSRJ-F16-BP06P	BH SSL F	DN 25	1"	-16	SSL F	DN 25	1"	-16	BSP CS	3/8"	3/8-19
BHSRJ-F32-BP06P	BH SSL F	DN 51	2"	-32	SSL F	DN 51	2"	-32	BSP CS	3/8"	3/8-19



BHCR-F-M

Bulkhead Compact Female to Compact Male - Straight
BHCPF-CPM

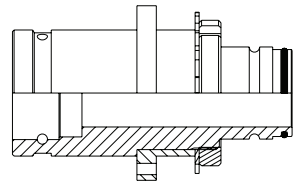

PRODUCT CODE	T1				T2			
	TYPE	NOMINAL BORE			TYPE	NOMINAL BORE		
		DN	INCH	DASH		DN	INCH	DASH
BHCR-F24M24	BH CP F	DN 38	1 1/2"	-24	CP M	DN 38	1 1/2"	-24
BHCR-F32M32	BH CP F	DN 51	2"	-32	CP M	DN 51	2"	-32
BHCR-F40M40	BH CP F	DN 63	2 1/2"	-40	CP M	DN 63	2 1/2"	-40



BHCR-F-M x BP

Bulkhead Compact Female to Compact Male x BSP Port - Straight
BHCPF-CPM x BP

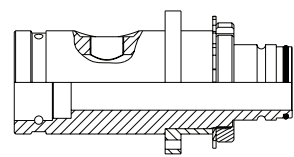

PRODUCT CODE	T1				T2				P1		
	TYPE	NOMINAL BORE			TYPE	NOMINAL BORE			TYPE	THREAD	
		DN	INCH	DASH		DN	INCH	DASH		INCH	TPI
BHCR-F32M32-P06	BH CP F	DN 51	2"	-32	CP M	DN 51	2"	-32	BSP F	3/8"	3/8-19
BHCR-F40M40-P06	BH CP F	DN 63	2 1/2"	-40	CP M	DN 63	2 1/2"	-40	BSP F	3/8"	3/8-19
BHCR-F40M40-P16	BH CP F	DN 63	2 1/2"	-40	CP M	DN 63	2 1/2"	-40	BSP F	1"	1-11



BHCJ-F-F

Bulkhead Compact Female to Compact Female - Straight
BHCPF-CPF

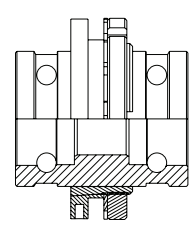

PRODUCT CODE	T1				T2			
	TYPE	NOMINAL BORE			TYPE	NOMINAL BORE		
		DN	INCH	DASH		DN	INCH	DASH
BHCJ-F24	BH CP F	DN 38	1 1/2"	-24	CP F	DN 38	1 1/2"	-24
BHCJ-F32	BH CP F	DN 51	2"	-32	CP F	DN 51	2"	-32
BHCJ-F40	BH CP F	DN 63	2 1/2"	-40	CP F	DN 63	2 1/2"	-40



BHCJ-F-F x BP
Bulkhead Compact Female to
Compact Female x BSP Port - Straight
BHCPF-CPF x BP

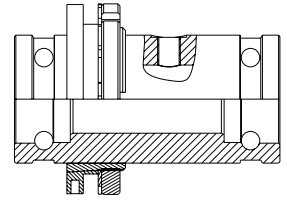

PRODUCT CODE	T1				T2				P1		
	TYPE	NOMINAL BORE			TYPE	NOMINAL BORE			TYPE	THREAD	
		DN	INCH	DASH		DN	INCH	DASH		INCH	TPI
BHCJ-F32-P06	BH CP F	DN 51	2"	-32	CP F	DN 51	2"	-32	BSP F	1"	1-11

ACCESSORIES

RAPID ACCESSORIES144

SUPER RAPID ACCESSORIES146

COMPACT ACCESSORIES148

GENERAL ACCESSORIES149



VISUAL INDEX

ACCESSORIES - RAPID

	RBR Rapid SL Male End Back-Up Ring SL BACK-UP RING	144
---	---	------------

	ROR Rapid SL Male End O-Ring SL O-RING	144
---	---	------------

	RS SL Staple SL STAPLE	144
---	-------------------------------------	------------

	RS-SS SL Staple - Stainless Steel SL STAPLE SS	145
---	---	------------

	RS-SS-L SL Staple - Stainless Steel - Long SL STAPLE SS L	145
---	--	------------

ACCESSORIES - SUPER RAPID

	SRBR Super Rapid SL Male End Back-Up Ring SSL BACK-UP RING	146
---	---	------------

	SROR Super Rapid SL Male End O-Ring SSL O-RING	146
---	---	------------

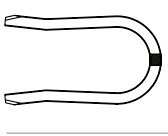
	SRS Super Rapid SL Staple SSL STAPLE	146
---	---	------------

	SRRR Super Rapid SL Retaining Ring SSL RETAINING RING	147
---	--	------------

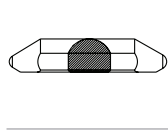
	SRRP Super Rapid SL Retaining Pin SSL RETAINING PIN	147
---	--	------------

ACCESSORIES - COMPACT

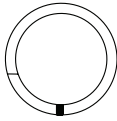
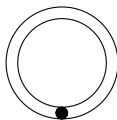
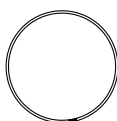
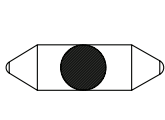
	<p>CBR Compact Back-Up Ring CP BACK-UP RING</p>	148
	<p>COR Compact O-Ring CP O-RING</p>	148
	<p>CRR Compact Retaining Ring CP RETAINING RING</p>	148
	<p>CRP Compact Retaining Pin CP RETAINING PIN</p>	148

ACCESSORIES - GENERAL

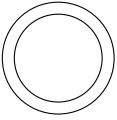
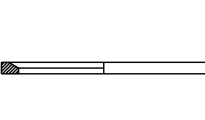
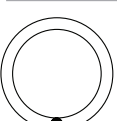
	<p>BPIHS BSP Internal Hex Adapter Seal BSP IH SEAL</p>	149
	<p>BPCS BSP Captive Seal BSP CAPTIVE SEAL</p>	149
	<p>BPCO BSP Captive O-Ring BSP CAPTIVE O-RING</p>	149

ACCESSORIES - RAPID



RBR
Rapid SL Male End Back-Up Ring
SL BACK-UP RING

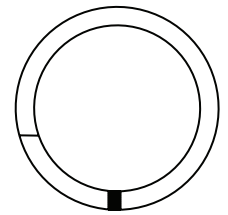

PRODUCT CODE	TYPE	NOMINAL BORE		
		DN	INCH	DASH
RBR-04	SL BR	DN 06	1/4"	-04
RBR-06	SL BR	DN 10	3/8"	-06
RBR-08	SL BR	DN 12	1/2"	-08
RBR-12	SL BR	DN 19	3/4"	-12
RBR-16	SL BR	DN 25	1"	-16
RBR-20	SL BR	DN 31	1 1/4"	-20
RBR-24	SL BR	DN 38	1 1/2"	-24
RBR-32	SL BR	DN 51	2"	-32
RBR-40	SL BR	DN 63	2 1/2"	-40
RBR-48	SL BR	DN 76	3"	-48



ROR
Rapid SL Male End O-Ring
SL O-RING

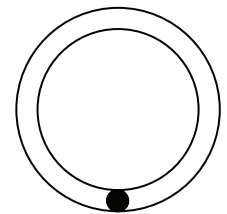

PRODUCT CODE	TYPE	NOMINAL BORE		
		DN	INCH	DASH
ROR-04	SL OR	DN 06	1/4"	-04
ROR-06	SL OR	DN 10	3/8"	-06
ROR-08	SL OR	DN 12	1/2"	-08
ROR-12	SL OR	DN 19	3/4"	-12
ROR-16	SL OR	DN 25	1"	-16
ROR-20	SL OR	DN 31	1 1/4"	-20
ROR-24	SL OR	DN 38	1 1/2"	-24
ROR-32	SL OR	DN 51	2"	-32
ROR-40	SL OR	DN 63	2 1/2"	-40
ROR-48	SL OR	DN 76	3"	-48



RS
SL Staple
SL STAPLE

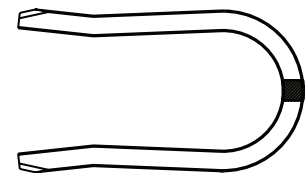

PRODUCT CODE	TYPE	NOMINAL BORE		
		DN	INCH	DASH
RS-04	SL S	DN 06	1/4"	-04
RS-06	SL S	DN 10	3/8"	-06
RS-08	SL S	DN 12	1/2"	-08
RS-12	SL S	DN 19	3/4"	-12
RS-16	SL S	DN 25	1"	-16
RS-20	SL S	DN 31	1 1/4"	-20
RS-24	SL S	DN 38	1 1/2"	-24
RS-32	SL S	DN 51	2"	-32



RS-SS
SL Staple - Stainless Steel
SL STAPLE SS

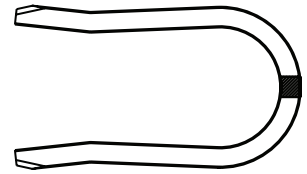

PRODUCT CODE	TYPE	NOMINAL BORE		
		DN	INCH	DASH
RS-SS-04	SL S SS	DN 06	1/4"	-04
RS-SS-06	SL S SS	DN 10	3/8"	-06
RS-SS-08	SL S SS	DN 12	1/2"	-08
RS-SS-12	SL S SS	DN 19	3/4"	-12
RS-SS-16	SL S SS	DN 25	1"	-16
RS-SS-20	SL S SS	DN 31	1 1/4"	-20
RS-SS-24	SL S SS	DN 38	1 1/2"	-24
RS-SS-32	SL S SS	DN 51	2"	-32
RS-SS-40	SL S SS	DN 63	2 1/2"	-40
RS-SS-48	SL S SS	DN 76	3"	-48



RS-SS-L
SL Staple - Stainless Steel - Long
SL STAPLE SS L

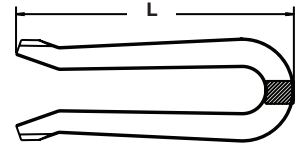

PRODUCT CODE	TYPE	NOMINAL BORE			L
		DN	INCH	DASH	
RS-SS-L-04-XXX	SL S SS L	DN 06	1/4"	-04	TBS
RS-SS-L-06-XXX	SL S SS L	DN 10	3/8"	-06	TBS
RS-SS-L-08-XXX	SL S SS L	DN 12	1/2"	-08	TBS
RS-SS-L-12-XXX	SL S SS L	DN 19	3/4"	-12	TBS
RS-SS-L-32-XXX	SL S SS L	DN 51	2"	-32	TBS

Pin Length L (mm) to be specified

ACCESSORIES - SUPER RAPID



SRBR

Super Rapid SL Male End Back-Up Ring
SSL BACK-UP RING

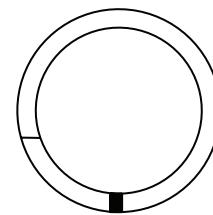

PRODUCT CODE	TYPE	NOMINAL BORE		
		DN	INCH	DASH
SRBR-08	SSL BR	DN 12	1/2"	-08
SRBR-12	SSL BR	DN 19	3/4"	-12
SRBR-16	SSL BR	DN 25	1"	-16
SRBR-20	SSL BR	DN 31	1 1/4"	-20
SRBR-24	SSL BR	DN 38	1 1/2"	-24
SRBR-32	SSL BR	DN 51	2"	-32



SROR

Super Rapid SL Male End O-Ring
SSL O-RING

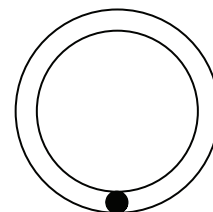

PRODUCT CODE	TYPE	NOMINAL BORE		
		DN	INCH	DASH
SROR-08	SSL OR	DN 12	1/2"	-08
SROR-12	SSL OR	DN 19	3/4"	-12
SROR-16	SSL OR	DN 25	1"	-16
SROR-20	SSL OR	DN 31	1 1/4"	-20
SROR-24	SSL OR	DN 38	1 1/2"	-24
SROR-32	SSL OR	DN 51	2"	-32



SRS

Super Rapid SL Staple
SSL STAPLE

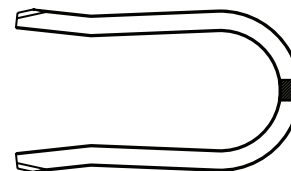

PRODUCT CODE	TYPE	NOMINAL BORE		
		DN	INCH	DASH
SRS-08	SSL S	DN 12	1/2"	-08
SRS-12	SSL S	DN 19	3/4"	-12
SRS-16	SSL S	DN 25	1"	-16
SRS-20	SSL S	DN 31	1 1/4"	-20
SRS-24	SSL S	DN 38	1 1/2"	-24
SRS-32	SSL S	DN 51	2"	-32



SRRR
Super Rapid SL Retaining Ring
SSL RETAINING RING

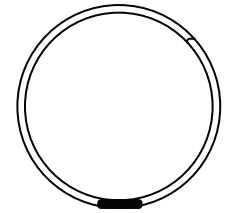

PRODUCT CODE	TYPE	NOMINAL BORE		
		DN	INCH	DASH
SRRR-08	SSL RR	DN 12	1/2"	-08
SRRR-12	SSL RR	DN 19	3/4"	-12
SRRR-16	SSL RR	DN 25	1"	-16
SRRR-20	SSL RR	DN 31	1 1/4"	-20
SRRR-24	SSL RR	DN 38	1 1/2"	-24
SRRR-32	SSL RR	DN 51	2"	-32



SRRP
Super Rapid SL Retaining Pin
SSL RETAINING PIN

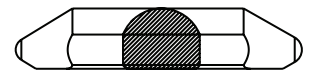

PRODUCT CODE	TYPE	NOMINAL BORE		
		DN	INCH	DASH
SRRP-08	SSL RP	DN 12	1/2"	-08
SRRP-12	SSL RP	DN 19	3/4"	-12
SRRP-16	SSL RP	DN 25	1"	-16
SRRP-20	SSL RP	DN 31	1 1/4"	-20
SRRP-24	SSL RP	DN 38	1 1/2"	-24
SRRP-32	SSL RP	DN 51	2"	-32

ACCESSORIES - COMPACT



CBR
Compact Back-Up Ring
CP BACK-UP RING

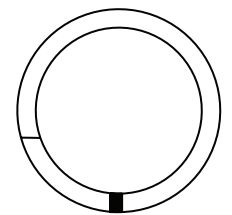

PRODUCT CODE	TYPE	NOMINAL BORE		
		DN	INCH	DASH
CBR-40	CP BR	DN 63	2 1/2"	-40



COR
Compact O-Ring
CP O-RING

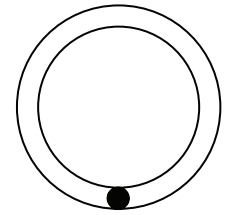

PRODUCT CODE	TYPE	NOMINAL BORE		
		DN	INCH	DASH
COR-20	CP OR	DN 31	1 1/4"	-20
COR-24	CP OR	DN 38	1 1/2"	-24
COR-32	CP OR	DN 51	2"	-32
COR-40	CP OR	DN 63	2 1/2"	-40



CRR
Compact Retaining Ring
CP RETAINING RING

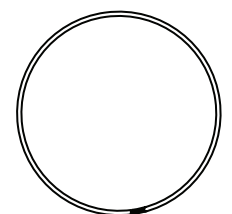

PRODUCT CODE	TYPE	NOMINAL BORE		
		DN	INCH	DASH
CRR-20	CP	DN 31	1 1/4"	-20
CRR-24	CP	DN 38	1 1/2"	-24
CRR-32	CP	DN 51	2"	-32
CRR-40	CP	DN 63	2 1/2"	-40



CRP
Compact Retaining Pin
CP RETAINING PIN

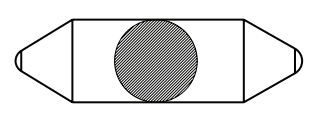

PRODUCT CODE	TYPE	NOMINAL BORE		
		DN	INCH	DASH
CRP-20	CP	DN 31	1 1/4"	-20
CRP-24	CP	DN 38	1 1/2"	-24
CRP-32	CP	DN 51	2"	-32
CRP-40	CP	DN 63	2 1/2"	-40



BPIHS
BSP Internal Hex Adapter Seal
BSP IH SEAL

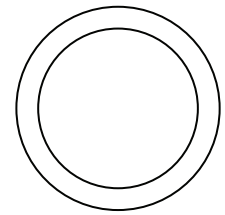

PRODUCT CODE	TYPE	NOMINAL BORE		
		DN	INCH	DASH
BPIHS-12	SEAL	DN 19	3/4"	-12



BPCS
BSP Captive Seal
BSP CAPTIVE SEAL

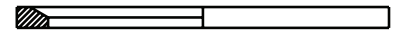

PRODUCT CODE	TYPE	NOMINAL BORE		
		DN	INCH	DASH
BPCS-04	BSP CS	DN 06	1/4"	-04
BPCS-06	BSP CS	DN 10	3/8"	-06
BPCS-08	BSP CS	DN 12	1/2"	-08
BPCS-12	BSP CS	DN 19	3/4"	-12
BPCS-16	BSP CS	DN 25	1"	-16
BPCS-20	BSP CS	DN 31	1 1/4"	-20
BPCS-24	BSP CS	DN 38	1 1/2"	-24



BPCO
BSP Captive O-Ring
BSP CAPTIVE O-RING

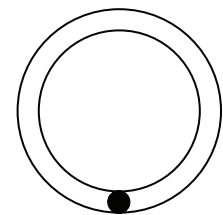

PRODUCT CODE	TYPE	NOMINAL BORE		
		DN	INCH	DASH
BPCO-32	BSP CO	DN 51	2"	-32
BPCO-40	BSP CO	DN 63	2 1/2"	-40
BPCO-48	BSP CO	DN 76	3"	-48

BALL VALVES

RAPID STAPLE-LOCK
BALL VALVES.....153

SUPER RAPID STAPLE-LOCK
BALL VALVES.....155

BALL VALVES
HANDLE OPTIONS156

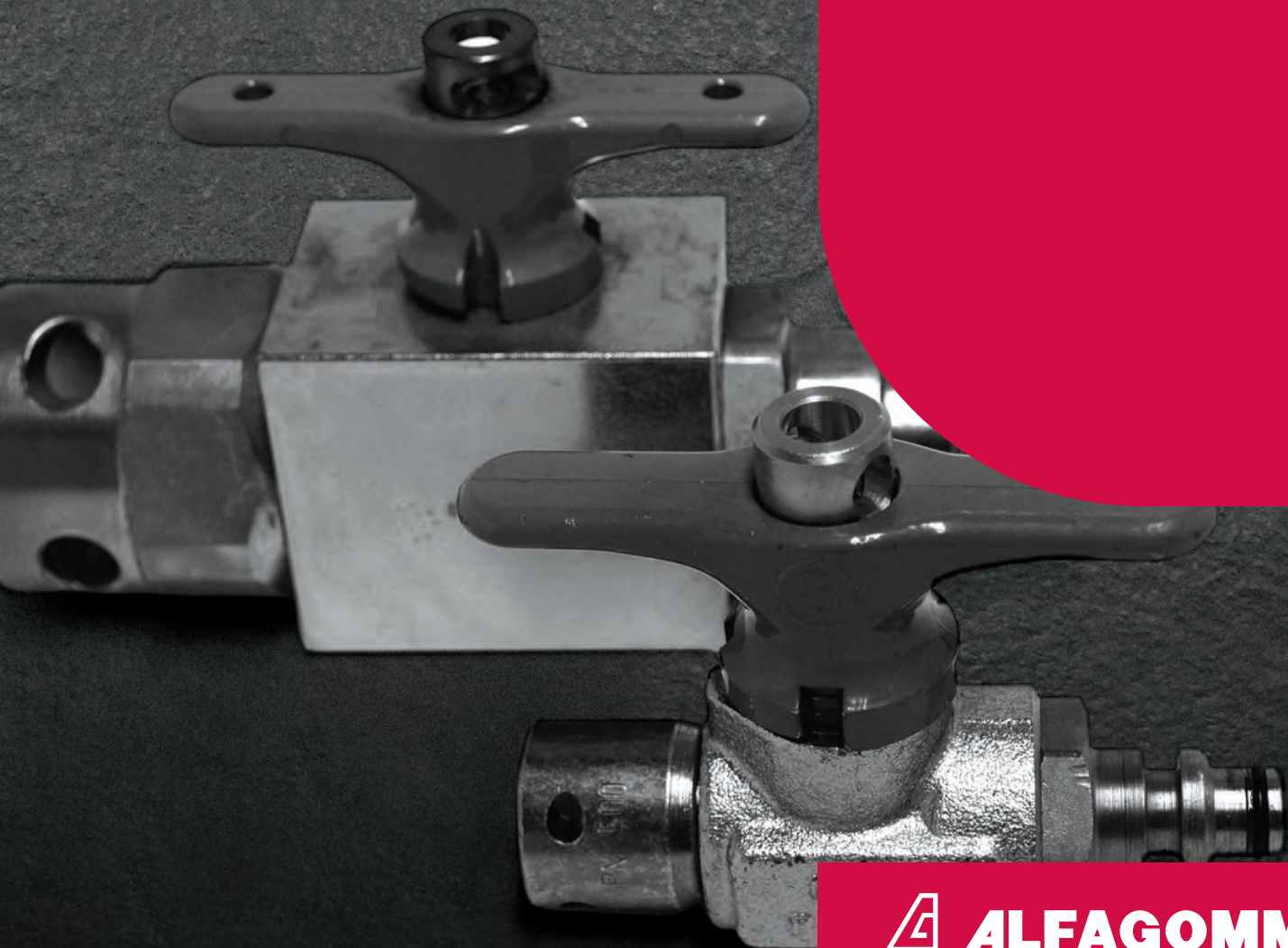

VISUAL INDEX

RAPID STAPLE-LOCK BALL VALVES

	<p>RBV2-F-F Ball Valve Rapid SL Female To Rapid SL Female - Block Square Body RBV-2-SLF-SLF</p>	153
--	--	------------

	<p>RBV2-FS-FS Ball Valve Rapid SL Female Swivel To Rapid SL Female Swivel - Block Square Body RBV-2-SLFS-SLFS</p>	153
--	--	------------

	<p>RBV3-F-M Ball Valve Rapid SL Female To Rapid SL Male - Block Square Body with Mounting Holes RBV-3-SLF-SLM</p>	153
--	--	------------

	<p>RBV1-FS-M Ball Valve Rapid SL Female Swivel To Rapid SL Male - Forged Body RBV-1-SLFS-SLM</p>	154
--	---	------------

	<p>RBV2-FS-M Ball Valve Rapid SL Female Swivel To Rapid SL Male - Block Square Body RBV-2-SLFS-SLM</p>	154
--	---	------------

SUPER RAPID STAPLE-LOCK BALL VALVES

	<p>SRBV1-F-M Ball Valve Super Rapid SL Female To Super Rapid SL Male - Forged Body SRBV-1-SSLF-SSLM</p>	155
--	--	------------

	<p>SRBV2-F-M Ball Valve Super Rapid SL Female To Super Rapid SL Male - Block Square Body SRBV-2-SSLF-SSLM</p>	155
--	--	------------

BALL VALVES HANDLE OPTIONS

	<p>HANDLE OPTIONS CODIFICATION</p>	156
--	---	------------

RBV2-F-F
**Ball Valve Rapid SL Female to Rapid SL Female
Block Square Body**
RBV-2-SLF-SLF

PRODUCT CODE	BODY TYPE	MAX WP MPA	T1				T2			
			TYPE	NOMINAL BORE			TYPE	NOMINAL BORE		
				DN	INCH	DASH		DN	INCH	DASH
RBV2-F0404-HCL	BLOCK-S	50	SL F	DN 06	1/4"	-04	SL F	DN 06	1/4"	-04
RBV2-F0406-HCL	BLOCK-S	50	SL F	DN 06	1/4"	-04	SL F	DN 10	3/8"	-06
RBV2-F0606-HCL	BLOCK-S	50	SL F	DN 10	3/8"	-06	SL F	DN 10	3/8"	-06
RBV2-F0808-HCL	BLOCK-S	50	SL F	DN 12	1/2"	-08	SL F	DN 12	1/2"	-08
RBV2-F1212-HCL	BLOCK-S	50	SL F	DN 19	3/4"	-12	SL F	DN 19	3/4"	-12
RBV2-F1616-HCL	BLOCK-S	35	SL F	DN 25	1"	-16	SL F	DN 25	1"	-16

HCL - Refer to Handle Option Codification Table

RBV2-FS-FS
**Ball Valve Rapid SL Female to Swivel Rapid SL Female Swivel
Block Square Body**
RBV-2-SLFS-SLFS

PRODUCT CODE	BODY TYPE	MAX WP MPA	T1				T2			
			TYPE	NOMINAL BORE			TYPE	NOMINAL BORE		
				DN	INCH	DASH		DN	INCH	DASH
RBV2-FS0404-HCL	BLOCK-S	50	SL FS	DN 06	1/4"	-04	SL FS	DN 06	1/4"	-04
RBV2-FS0606-HCL	BLOCK-S	50	SL FS	DN 10	3/8"	-06	SL FS	DN 10	3/8"	-06
RBV2-FS0808-HCL	BLOCK-S	50	SL FS	DN 12	1/2"	-08	SL FS	DN 12	1/2"	-08
RBV2-FS1212-HCL	BLOCK-S	50	SL FS	DN 19	3/4"	-12	SL FS	DN 19	3/4"	-12
RBV2-FS1616-HCL	BLOCK-S	35	SL FS	DN 25	1"	-16	SL FS	DN 25	1"	-16

HCL - Refer to Handle Option Codification Table

RBV3-F-M
**Ball Valve Rapid SL Female to Rapid SL Male
Block Square Body with Mounting Holes**
RBV-3-SLF-SLM

PRODUCT CODE	BODY TYPE	MAX WP MPA	T1				T2			
			TYPE	NOMINAL BORE			TYPE	NOMINAL BORE		
				DN	INCH	DASH		DN	INCH	DASH
RBV3-F04M04-HCL	BLOCK-S-MH	50	SL F	DN 06	1/4"	-04	SL M	DN 06	1/4"	-04
RBV3-F06M06-HCL	BLOCK-S-MH	50	SL F	DN 10	3/8"	-06	SL M	DN 10	3/8"	-06
RBV3-F08M08-HCL	BLOCK-S-MH	50	SL F	DN 12	1/2"	-08	SL M	DN 12	1/2"	-08
RBV3-F12M12-HCL	BLOCK-S-MH	50	SL F	DN 19	3/4"	-12	SL M	DN 19	3/4"	-12
RBV3-F16M16-HCL	BLOCK-S-MH	35	SL F	DN 25	1"	-16	SL M	DN 25	1"	-16

HCL - Refer to Handle Option Codification Table

RAPID STAPLE-LOCK BALL VALVES

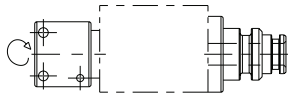

RBV1-FS-M

Ball Valve Rapid SL Female Swivel to Rapid SL Male Forged Body

RBV-1-SLFS-SLM

PRODUCT CODE	BODY TYPE	MAX WP MPA	T1				T2			
			TYPE	NOMINAL BORE			TYPE	NOMINAL BORE		
				DN	INCH	DASH		DN	INCH	DASH
RBV1-FS04M04-HCL	FORGED	50	SL FS	DN 06	1/4"	-04	SL M	DN 06	1/4"	-04
RBV1-FS06M06-HCL	FORGED	50	SL FS	DN 10	3/8"	-06	SL M	DN 10	3/8"	-06
RBV1-FS08M08-HCL	FORGED	50	SL FS	DN 12	1/2"	-08	SL M	DN 12	1/2"	-08
RBV1-FS12M12-HCL	FORGED	50	SL FS	DN 19	3/4"	-12	SL M	DN 19	3/4"	-12
RBV1-FS16M16-HCL	FORGED	32	SL FS	DN 25	1"	-16	SL M	DN 25	1"	-16

HCL - Refer to Handle Option Codification Table



RBV2-FS-M

Ball Valve Rapid SL Female Swivel to Rapid SL Male Block Square Body

RBV-2-SLFS-SLM

PRODUCT CODE	BODY TYPE	MAX WP MPA	T1				T2			
			TYPE	NOMINAL BORE			TYPE	NOMINAL BORE		
				DN	INCH	DASH		DN	INCH	DASH
RBV2-FS04M04-HCL	BLOCK-S	50	SL FS	DN 06	1/4"	-04	SL M	DN 06	1/4"	-04
RBV2-FS06M06-HCL	BLOCK-S	50	SL FS	DN 10	3/8"	-06	SL M	DN 10	3/8"	-06
RBV2-FS08M08-HCL	BLOCK-S	50	SL FS	DN 12	1/2"	-08	SL M	DN 12	1/2"	-08
RBV2-FS12M12-HCL	BLOCK-S	40	SL FS	DN 19	3/4"	-12	SL M	DN 19	3/4"	-12
RBV2-FS16M16-HCL	BLOCK-S	35	SL FS	DN 25	1"	-16	SL M	DN 25	1"	-16

HCL - Refer to Handle Option Codification Table

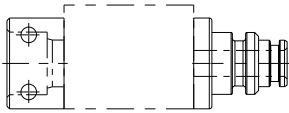

SRBV1-F-M

Ball Valve Super Rapid SL Female to Super Rapid SL Male Forged Body

SRBV-1-SSLF-SSLM

PRODUCT CODE	BODY TYPE	MAX WP MPA	T1				T2			
			TYPE	NOMINAL BORE			TYPE	NOMINAL BORE		
				DN	INCH	DASH		DN	INCH	DASH
SRBV1-F24M24-HCL	FORGED	40	SSL F	DN 38	1 1/2"	-24	SSL M	DN 38	1 1/2"	-24
SRBV1-F32M32-HCL	FORGED	50	SSL F	DN 51	2"	-32	SSL M	DN 51	2"	-32

HCL - Refer to Handle Option Codification Table

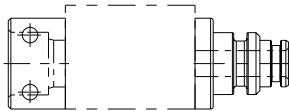

SRBV2-F-M

Ball Valve Super Rapid SL Female to Super Rapid SL Male Block Square Body

SRBV-2-SSLF-SSLM

PRODUCT CODE	BODY TYPE	MAX WP MPA	T1				T2			
			TYPE	NOMINAL BORE			TYPE	NOMINAL BORE		
				DN	INCH	DASH		DN	INCH	DASH
SRBV2-F08M08-HCL	BLOCK-S	50	SSL F	DN 12	1/2"	-08	SSL M	DN 12	1/2"	-08
SRBV2-F12M12-HCL	BLOCK-S	50	SSL F	DN 19	3/4"	-12	SSL M	DN 19	3/4"	-12
SRBV2-F16M16-HCL	BLOCK-S	42	SSL F	DN 25	1"	-16	SSL M	DN 25	1"	-16
SRBV2-F20M20-HCL	BLOCK-S	42	SSL F	DN 31	1 1/4"	-20	SSL M	DN 31	1 1/4"	-20

HCL - Refer to Handle Option Codification Table

BALL VALVES HANDLE OPTIONS



HANDLE OPTIONS CODIFICATION

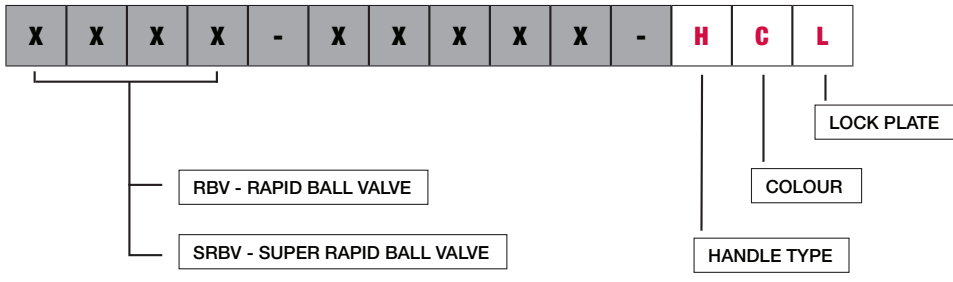

H HANDLE TYPE

1	HAND LEVER		
2	DOUBLE HANDLE		
3	HEXAGON		
4	SAFETY HANDLE		
5	SAFETY HANDLE - LOCKABLE		

C COLOUR

B	BLUE
G	GREEN
O	ORANGE
R	RED
W	WHITE

L LOCK PLATE

S	SQUARE		
R	ROUND		

HYDRAULIC HOSE

AT3K	41
AT4K	42
AT4K SUPERTUFF	45
AT5K	43
AT5K SUPERTUFF	46
AT6K	44
AT6K SUPERTUFF	46
AT7K	44
AT8K	44
FLEXOPAK 1SC.....	38
FLEXOPAK 2SC.....	38
FLEXOR 12	40
FLEXOR 13	40
FLEXOR 1SN-R1AT MSHA.....	36
FLEXOR 2SN-R2AT MSHA.....	36
FLEXOR 2ST-R2A MSHA	37
FLEXOR 3	35
FLEXOR 4SH	39
FLEXOR 4SP	39
FLEXOR 5	37
FLEXOR 6	35
FLEXOR T604	48
TEMP TECH 1SN	47
TEMP TECH 2SN	47

INDUSTRIAL HOSE

131AA	60
132AE	54
142AK	54
151AA	59
151AK	59
155AA	53
155AK	54
170AA	60
185AA	53
189AK	59
202AA	57
225AA	61
240AA	61
245AA	61
284AA	55
288HH	55
289GG	60
605AA	58
612AA	64
658AA	58

660AA	64
706AA	63
707AA	62
714HA	63
740AA	56
756AA	62
765AA	62
776AA	63
964AA	64

FERRULES

H1100104	70
H1100204	70
H1100404	70
H1200101	71
H1200102	71
H1200103	71
H1200202	72
H1200203	72
H1200204	73
H1200212	72
H1400200	74
H1400301	74
H1T00600	74

INSERTS

H1213H10	82
H1214810	78
H1214840	78
H1214890	78
H1223H10	82
H1224810	79
H1413H10	83
H1414810	80
H1414A10	81
H1423H10	83
H1424A10	81
H1424B10	81

ADAPTERS

BHCJ-F-F	138
BHCJ-F-F × BP	139
BHCR-F-M	138
BHR4-F-M-SE	135
BHR9-F-M-SE	135
BHRJ-F-F	136
BHRJ-F-F × BP	136
BHRR-F-M	135

BHRR-F-M × BP	135
BHSR9-F-M-SE	137
BHSRJ-F-F	137
BHSRJ-F-F × BPCS	138
BHSRR-F-M	136
BHSRR-F-M × BPCS	137
CC-F	131
CJ-F	131
CN-M	131
CN-M-RM	132
CP-M	131
CR-F-M	132
CR-F-M × BP	132
CR-F-RM	133
CTA-F-BPMCO	134
CTA-F-BPMCS	133
CTA-F-BTM	133
CTA-M-BPMCO	134
CTA-M-BPMCS	134
CTA-M-BTM	133
R4-F-M	104
R4-F-M-SE	119
R4-F-SE	118
R4-FS	99
R4-FS-M	106
R9-F	97
R9-F-M	104
R9-F-M-SE	119
R9-FS	100
R9-FS-M	107
RB-F-BJB-BP	114
RB-FS-BJA-BPM	115
RB-FS-BJB-BP	114
RB-BOLT-BPM	115
RC	98
RJ-F	96
RJ-FS	99
RJ-F × BP	96
RJ-F × BT	96
RN-M	101
RN-M-L	102
RP	102
RR-F-M	103
RR-FS-M	106
RT-F	97
RT-F-F-M	105
RT-F-M-F	105

RT-FS.....	100	SRR-M-FL6K.....	129
RT-FS-FS-M	108	SRR-RF-M.....	125
RT-FS-M-FS	107	SRT-F.....	121
RTA-F-BPMCO	108	SRT-F-M-F.....	126
RTA-F-BPMCS	108	SRT-F-M-RF	126
RTA-F-BTM.....	109	SRT-FS	122
RTA-F-NM	109	SRTA-F-BPMCO.....	127
RTA-FS-BPMCO.....	111	SRTA-F-BPMCS	127
RTA-FS-BPMCS	110	SRTA-FS-BPMIH	127
RTA-FS-BPMIH	109	SRTA-M-BPMCO.....	128
RTA-FS-BTM	111	SRTA-M-BPMCS.....	128
RTA-FS-NM	113		
RTA-FS-SORB.....	112	ACCESSORIES	
RTA-M-BPMCO	116	BPCO	149
RTA-M-BPMCS	116	BPCS.....	149
RTA-M-BTM	115	BPIHS.....	149
RTA-M-NM	117	CBR.....	148
RTA-M-SORB.....	118	COR.....	148
RTA4-FS-SORB.....	112	CRP	148
RTA9-F-BTM.....	109	CRR	148
RTA9-F-NM	110	RBR	144
RTA9-FS-BTM	111	ROR.....	144
RTA9-FS-NM	114	RS.....	144
RTA9-FS-SORB.....	113	RS-SS.....	145
RX-F	98	RS-SS-L	145
RY-F.....	98	SRBR.....	146
SR3-F-M-SE.....	129	SROR.....	146
SR4-F-M.....	124	SRRP	147
SR4-F-M-SE.....	129	SRRR.....	147
SR4-F-SE	130	SRS	146
SR4-FS-M	125		
SR9-F	121	BALL VALVES	
SR9-F-M.....	124	RBV1-FS-M.....	154
SR9-F-M-SE.....	130	RBV2-F-F	153
SR9-F-SE	130	RBV2-FS-FS.....	153
SR9-FS-M	125	RBV2-FS-M	154
SRC-F.....	121	RBV3-F-M	153
SRJ-F	120	SRBV1-F-M	155
SRJ-F × BPCS.....	120	SRBV2-F-M	155
SRJ42-F	120		
SRN-M.....	122		
SRP-M.....	122		
SRR-F-FL6K.....	128		
SRR-F-M	123		
SRR-F-M-L.....	123		
SRR-F-M × BPCS	124		

North American Market only

The Products sold or distributed by Seller are warranted to its customers to be free from defects in material and workmanship at the time of shipment by us, subject to the following provisions:

all warranty claims shall be made within six (6) months after seller shipped the products. seller's liability and customer's remedy hereunder, under any theory of law or equity, including without limitation, for breach of contract, negligence, or otherwise, is limited, at seller's exclusive discretion, solely to 1) the purchase price of any products proving defective; 2) repair of any defective product or part thereof; or 3) replacement of any defective product or part upon its authorized return to seller.

This warranty is in lieu of and excludes, without limitation and to the fullest extent allowable by law, all other warranties or conditions, expressed, implied, statutory, or otherwise created under applicable law including, but not limited to, the warranty of merchantability, the warranty of fitness for a particular purpose, conditions of satisfactory quality, any obligation or warranty to remote purchasers, and those from a course of dealing or usage of trade.

In addition, this warranty shall not apply to any products or portions thereof that have been subjected to abuse, misuse, improper installation, maintenance, or operation, electrical failure or abnormal conditions, and to products that have been tampered with, altered, modified, repaired, reworked by anyone not approved by seller, or used in any manner inconsistent with any instructions or specifications provided with or for the product.

In no event shall seller or the manufacturer of the product have any liability whatsoever to any person, including without limitation, any immediate buyer, remote purchaser, or other third party, for any special, punitive, incidental, or consequential damages, including without limitation, loss of profits of customer or any other person, loss or damage to physical property of customer or any other person, and loss of anticipated revenue, profits, goodwill, savings, or other economic loss of customer or any other person, even if advised of the possibility thereof in advance, whether or not arising in, caused by, or resulting from, breach of contract, the negligence of seller and/or the manufacturer of the product, or otherwise, unless specifically provided herein and except any liability that cannot be excluded or limited by applicable law.

There are no warranties that extend beyond the description on the face hereof.



ALFAGOMMA

www.alfagomma.com